

# Cottam Solar Project

## Environmental Statement Appendix 14.2: Construction Traffic Management Plan Revision D

Prepared by: Transport Planning Associates  
December 2023

PINS reference: EN010133  
Document reference: EX3/C6.3.14.2\_D  
APFP Regulation 5(2)(a)



A Planning Application by  
**COTTAM SOLAR PROJECTS LIMITED**

In respect of  
**Cottam Solar Farm,  
LINCOLNSHIRE**

## Outline Construction Traffic Management Plan

December 2023



## Document Management

© 2023 Transport Planning Associates Limited. All Rights Reserved.

This document has been prepared by Transport Planning Associates for the sole use of our client in accordance with generally accepted consultancy principles, the budget for fees and the terms of service agreed between Transport Planning Associates and our client. Any information provided by third parties and referred to herein has not been checked or verified by Transport Planning Associates, unless otherwise expressly stated in the document. No third parties may rely upon this document without the prior and express written agreement of Transport Planning Associates.

### Document Review

	Status	Author	Checker	Approver	Date
01	Draft	AG	RR	JD	12   05   22
-	Issue	AG	RR	JD	09   12   22
A	Revision <sup>a</sup>	AG	RR	JD	21   12   22
B	Revision <sup>b</sup>	AC	RR	JD	21   07   23
C	Revision <sup>c</sup>	AC	RR	JD	16   10   23
D	Revision <sup>d</sup>	AC	RR	JD	20   11   23
E	Revision <sup>e</sup>	AC	RR	JD	14   12   23

Issued by:

**Bristol**  
 Cambridge  
 London  
 Manchester  
 Oxford  
 Welwyn Garden City

**Transport Planning Associates**  
 25 King Street  
 Bristol  
 BS1 4PB

0117 925 9400  
 bristol@tpa.uk.com  
 www.tpa.uk.com

---

a  
 b  
 c  
 d  
 e

<b>Contents</b>		<b>Page</b>
1	Introduction	1
2	Construction Works	3
3	Construction Site Access Arrangements	7
4	Construction Vehicle Trip Generation	13
5	Construction Vehicle Routing	17
6	Abnormal Loads	27
7	Construction Traffic Mitigation and Management Measures	31

## List of Figures

Figure 3.1	Access Locations – Cottam 1, 2 and 3
Figure 3.2	Access Locations – Cable Route Corridor
Figure 5.1	Construction Vehicle Route – Cottam 1 South
Figure 5.2	Construction Vehicle Route – Cottam 1 North
Figure 5.3	Construction Vehicle Route – Cottam 1 West
Figure 5.4	Construction Vehicle Route – Cottam 2
Figure 5.5	Construction Vehicle Route – Cottam 3a
Figure 5.6	Construction Vehicle Route – Cottam 3b
Figure 5.7	Cable Route Corridor Construction Vehicle Route
Figure 6.1	Abnormal Load Routes

## List of Appendices

A	Order Limits
B	Indicative Access Arrangement Drawings – Cottam 1, 2, 3a and 3b
C	Indicative Access Arrangement Drawings – Cable Route Corridor
D	Construction Worker Travel Plan

# 1 Introduction

- 1.1 This Outline Construction Traffic Management Plan (CTMP) has been prepared by Transport Planning Associates (TPA) on behalf of Cottam Solar Project Ltd (the 'Applicant') in relation to an application for a Development Consent Order (DCO) for Cottam Solar Project (hereafter referred to as the 'Scheme').
- 1.2 The Scheme is situated within the jurisdiction of West Lindsey District Council, who act as the local planning authority. Lincolnshire County Council is the highway authority. A small section of the Cable Route Corridor is located within the jurisdiction of Bassetlaw District Council. Nottinghamshire County Council is the highway authority here.

## The Scheme

- 1.3 The Scheme will comprise the construction, operation, maintenance, and decommissioning of a solar photovoltaic (PV) array electricity generating station and Energy Storage Facility with a total capacity exceeding 50 megawatts (MW), and export connection to the National Grid. The grid connection point will be at the National Grid substation at Cottam Power Station.
- 1.4 The Order Limits are shown in **DCO Core Plan 1** [EN010133/APP/C2.1]. This is shown in **Appendix A**.

## This Document

- 1.5 This Outline CTMP provides a framework for the management of construction vehicle movements to and from the Site, to ensure that the effect of the construction phase on the local highway network is minimised. It is an evolving document that will be updated prior to construction to reflect any considerations made during the DCO process, and to add detail that arises from the post-determination procurement and Engineering Principal Contractor (EPC) appointment. A Final CTMP, substantially in the same form as this Outline CTMP, will be approved by the relevant planning authorities in consultation with the Local Highway Authorities prior to construction commencing.
- 1.6 The CTMP has the following objectives:
- Minimise the number of HGVs and other vehicles on the local road network that are associated with the construction of the Scheme;
  - Ensure the safe movement of equipment, material and construction workers;
  - Minimise the effects of construction traffic on the local community; and
  - Set out measures to be adhered to by all associated with the construction of the Scheme.
- 1.7 This CTMP is structured as follows:

- Construction methodology;
- Site access;
- Construction vehicle trip generation;
- Construction vehicle routing;
- Abnormal load movement; and
- Mitigation and management measures.

- 1.8 It will be the responsibility of the undertaker to ensure that the appointed contractor complies with all statutory regulations and guidelines in relation to construction and movement activities.
- 1.9 This Outline CTMP has been prepared following various stages of consultation, and through discussions with officers at Lincolnshire County Council. It should be read in conjunction with **Chapter 14** of the **Environmental Statement** [EN010133/APP/C6.2.14], and the **Transport Assessment** at **Appendix 14.1** [EN010133/APP/C6.3.14.1].

## 2 Construction Works

- 2.1 The section provides an overview of the Scheme and the construction programme.
- 2.2 A full overview of the Scheme can be found in ES Chapter 3 on the 'Order Limits' [EN010133/APP/C6.2.3], and ES Chapter 4 on the 'Scheme Description' [EN010133/APP/C6.2.3]. Additional information on the Grid Connection can be found in the 'Grid Connection Statement' [EN010133/APP/C7.7]

### Solar Array Works Area

- 2.3 The main element of the Scheme comprises four Sites that will accommodate the solar arrays. These are referred to as:
- **Cottam 1** – 587ha, made up of a number of fields centred on the village of Coates. Split into Cottam 1 South, Cottam 1 North, and Cottam 1 West;
  - **Cottam 2** – 109ha, located to the north of Cottam 1 and to the east of the village of Corringham;
  - **Cottam 3a** – 139ha, located to the north of Cottam 2, to the north of the B1205, and to the east of the village of Blyton;
  - **Cottam 3b** – 62ha, located to the south of Cottam 3a and to the east of Station Road.
- 2.4 The key equipment within the Solar Array Works Areas are:
- **Solar PV Panels** – to convert sunlight into electrical current;
  - **Mounting Structures** – Solar PV Panels will be mounted on a metal assembly of PV Mounting Structures. This includes metal rails to directly support the PV Panels, which themselves are supported by larger metal frames which are fixed on top of metal piles;
  - **Conversion Units** – The Conversion Units incorporate inverters, transformers and switchgear and are required to manage the electricity generated by the PV Panels;
  - **Electric Cabling** – Electrical cabling will be required as part of the Generating Stations to connect PV Panels to the Conversion Units.

### Energy Storage Facility

- 2.5 An Energy Storage Facility (also referred to as BESS) will be located with Cottam 1 (West).
- 2.6 The BESS is designed to provide peak generation and grid balancing services to the electricity grid by allowing excess electricity generated either from the solar PV panels, or imported from the electricity grid, to be stored in batteries and dispatched when required.

## Substations

- 2.7 Substations will be required at each Solar Farm Site. The substations will consist of electrical infrastructure such as the transformers, switchgear and metering equipment required to facilitate the export of electricity from each respective site.

## Grid Connection

- 2.8 The electricity generated by the Scheme will be exported to the National Grid substation at Cottam Power Station via a number of electrical cables sited within the defined Cable Route Corridor. These connections will also facilitate the import of electricity to be stored within the energy storage Facility at Cottam 1 West.

- 2.9 The Cable Route Corridor will be approximately 27.5km in length, and is directed across open countryside. It will require crossings of railways, watercourses, various utilities, Public Rights of Way (PRoW) and roads. The construction of the Grid Connection Route includes the following elements:

- Construction of Haul Road and Laydown Areas;
- Open Cut Excavation;
- Construction of Joint Bays; and
- Cabling/Joining.

- 2.10 The cable route corridor will be built out in sections over a 24 month period, with each section requiring a number of site accesses which will be in use simultaneously. It has been estimated that each section will be approximately 4.4km. Each section will take approximately 90 working days to construct.

## Other Works

### *Contractors Compound*

- 2.11 Construction compounds will be set up within each area. These will accommodate storage, parking, offices and welfare facilities.
- 2.12 Appropriate parking will be provided within each construction compound. No parking by contractors, visitors or delivery vehicles will be permitted on the local highway network or the Site access road at any time during the construction phase, and visitors will be advised of the parking arrangements in advance of travelling to the Site. The Site Manager will monitor that parking is taking place in the designated area on a regular basis.



### *Internal Routing*

- 2.13 The Scheme will include internal access roads throughout the Site allowing for the movement of construction and maintenance vehicles. The internal access road will be completed during the initial stages of construction so that temporary haul routes are not necessary.
- 2.14 Appropriate turning areas will be provided in the vicinity of the internal access road to ensure all vehicles egress the Site in a forward gear.
- 2.15 A wheel washing facility, will be provided at the end of each access road, ahead of the egress onto the local highway network.
- 2.16 Other works include the following:
- Fencing, security and lighting;
  - Landscaping; and
  - Surface water drainage.

### *Security*

- 2.17 The Site will be secured at all times via a perimeter fence or temporary fencing. CCTV will be operational within the construction compound. All new access tracks will be secured by gates, which will be set back from the public highway. Where existing access tracks are used that also provide access to residential properties, appropriate security measures will be put in place in consultation with the relevant property owner(s).

### **Construction Programme**

- 2.18 The construction programme is anticipated to last approximately 24 months. The indicative construction programme is summarised in **Table 2.1**.

Table 2.1 Indicative Construction Programme

Site/Month	1	2	3	4	5	6	7	8	9	10	11	12	13	14	15	16	17	18	19	20	21	22	23	24
Cottam 1 (N)	█	█	█	█	█	█	█	█	█	█	█	█	█	█	█	█	█	█	█	█	█	█	█	█
Cottam 1 (S)	█	█	█	█	█	█	█	█	█	█	█	█	█	█	█	█	█	█	█	█	█	█	█	█
Cottam 1 (W)	█	█	█	█	█	█	█	█	█	█	█	█	█	█	█	█	█	█	█	█	█	█	█	█
Cottam 2	█	█	█	█	█	█	█	█	█	█	█	█	█	█	█	█	█	█	█	█	█	█	█	█
Cottam 3a	█	█	█	█	█	█	█	█	█	█	█	█	█	█	█	█	█	█	█	█	█	█	█	█
Cottam3b	█	█	█	█	█	█	█	█	█	█	█	█	█	█	█	█	█	█	█	█	█	█	█	█
BESS	█	█	█	█	█	█	█	█	█	█	█	█	█	█	█	█	█	█	█	█	█	█	█	█
Grid Connect	█	█	█	█	█	█	█	█	█	█	█	█	█	█	█	█	█	█	█	█	█	█	█	█

### 3 Construction Site Access Arrangements

- 3.1 This section summarises the accesses that will be used during the construction phase of the Scheme. Indicative Access Arrangement Drawings are shown within **Appendix B** and **Appendix C**.
- 3.2 Any access that is temporarily created for the construction period will be restored to its original condition post-construction.

#### Cottam 1, 2 and 3a and 3b

- 3.3 There will be a total of 17 access points for Cottam 1, 2 and 3a and 3b. Of these, 15 will be used for construction vehicle access. The access locations, as follows, are shown in **Figure 3.1**.

- Access 1: Thorpe Lane, at Thorpe Bridge;
- Access 2: Fleets Lane, 200m south of Ingham Road;
- Access 3: Stow Lane (North), between Blackthorn Hill and Furze Hill;
- Access 4: Stow Lane, Grange Farm access – **Operational Only**;
- Access 5: Willingham Road, Fillingham Grange track (North and South);
- Access 6: Willingham Road, Adj. North Farm;
- Access 7: Willingham Road, West of Turpins Farm;
- Access 8: Ingham Road, 100m east of 31 Ingham Road;
- Access 9: Green lane Track from Coates Lane to Ingham Road – **Operational Only**;
- Access 10: Coates Lane, at River Till Bridge;
- Access 11: Coates Lane, 200m east of River Till Bridge;
- Access 12: South Lane;
- Access 13: Stone Pit Lane, at Cot Garth Lane;
- Access 14: Unnamed road from East Lane to A631, adj. Corringham Grange;
- Access 15: B1205 Kirton Road, adj. Blyton Park Driving Centre;
- Access 16: B1205 Kirton Road, 150m west of JG Pears;
- Access 17: Station Road/Pilham Lane, adj. Glebe Farm.

Figure 2.1 Access Locations – Cottam 1, 2 3a and 3b

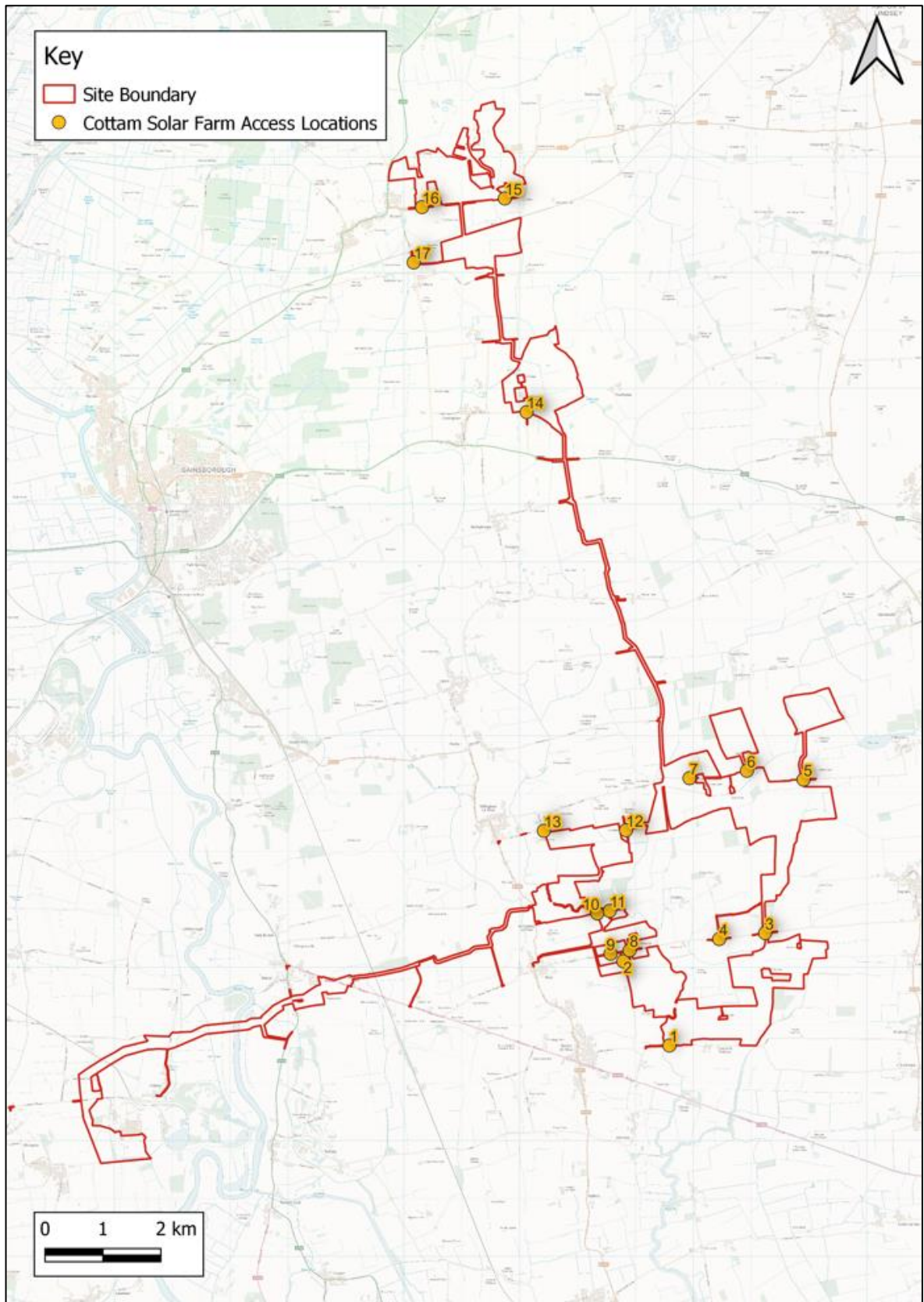

## Cable Route Corridor

3.4 For the construction of the Cable Route Corridor, 31 temporary accesses are required, approximately one every kilometre. The locations of these accesses are shown in **Figure 3.2**.

- Access 101: Torksey Ferry Road, opp. Nightleys Road;
- Access 102: Cottam Lane, 150m west of Cow Pasture Lane;
- Access 103: Cottam Lane, to the west of Cow Pasture Lane;
- Access 105: Headstead Bank (west), 250m south of Broad Lane;
- Access 106: Headstead Bank (east), south of Broad Lane;
- Access 107: A156 Lea Road, via Footpath Bram/66/1;
- Access 108: A156 High Street, 130m south of Chestnut House;
- Access 109: A1500 Stow Park Road (north), west of Marton;
- Access 110: A1500 Stow Park Road (south), west of Marton;
- Access 111: A1500 Stow Park Road, Marton Grange track;
- Access 112: A1500 Till Bridge Lane, Manor Farm track;
- Access 113: Wooden Lane;
- Access 114: B1241 Normanby Road, West Farm access;
- Access 115: B1241 Normanby Road, East Farm access;
- Access 116: South Lane, opp. Lowfield Farm;
- Access 117: South Lane, 200m south of Moor Farm;
- Access 118: Fillingham Lane;
- Access 119: Glentworth Road, 600m south of Kexby Road;
- Access 120: Kexby Road, 100m east of Glentworth Road;
- Access 121: Cow Lane, 1100m east of Upton Grange;
- Access 122: Common Lane (south), 250m east of Heapham Cliff;
- Access 123: Common Lane (north), 250m east of Heapham Cliff;
- Access 124: School Lane (south), 350m west of Grange Cottage;
- Access 125: School Lane (north), 350m west of Grange Cottage;
- Access 126: A631 Harpswell Lane (north), 600m west of Grange Lane;
- Access 127: A631 Harpswell Lane (south), 600m west of Grange Lane;
- Access 128: Unnamed Road (south), 400m east of Aisby;
- Access 129: Unnamed Road (north), 400m east of Aisby;
- Access 130: Green Lane, 400m west of Pilham Lane;
- Access 131: Green Lane, 400m west of Pilham Lane;
- Access 132: B1205 Kirton Road, 300m east of The Fields

Figure 3.2 Access Locations – Cable Route Corridor

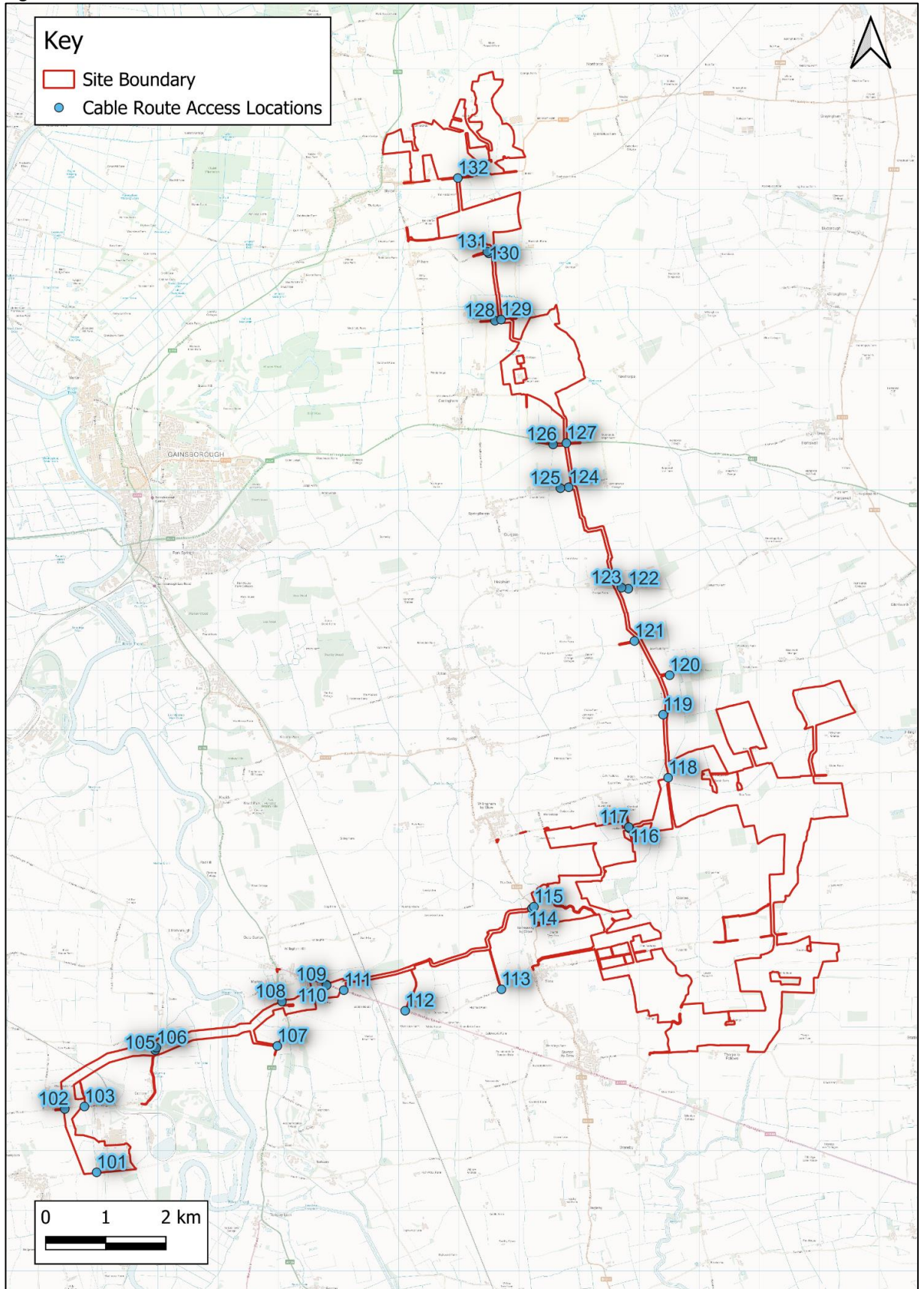

## Detailed Design

3.5 Prior to carrying out any works to the public highway pursuant to Articles 9, 10, 11 and 13 of the DCO, the detailed design of such works must be submitted to the highway authority for approval (either as part of the CTMP or separately) and include:

- A programme for the works, method statement and any traffic management proposals;
- Detailed technical drawings;
- Any health and safety documentation required under the CDM Regulations;
- Stage 1/2 Safety Audit; and
- Details of the contractor.

## Traffic Management/Regulation Measures

3.6 Details of the form and proposed locations of any signs or signals to be placed on a public highway pursuant to Article 15 of the DCO will be submitted to the traffic authority in advance of being placed (either as part of the CTMP or separately).

## Management of Accesses

3.7 All construction vehicles will access and egress the Site in a forward gear.

3.8 A booking system will be set up to manage arrivals and departures at each access. The intention of this procedure is to avoid instances of HGVs passing each other in opposite directions on the local roads surrounding the Site.

3.9 Banksmen will be deployed at each access whenever construction vehicles are accessing or egressing the Site. This will ensure the safe movement of construction vehicles in and out of the accesses.

3.10 Temporary signage will be erected in the vicinity of the accesses during the construction phase. Diagram 7301 'WORKS TRAFFIC' in the Traffic Signs Regulations and General Directions (TSRGD) will be used to indicate the access and will read 'WORKS TRAFFIC LARGE VEHICLE TURNING'. These signs will be white text and red background 1050 x 750 mm mounted in 'A' frames. The temporary signs will be in place for the duration of the construction phase.

3.11 At Access 15, which is shared with Blyton Park Driving Centre, specific management of the access during race days and other events will be put in place in consultation with the operators of Blyton Park Driving Centre, to ensure their operations are not significantly affected by the construction vehicle movements.

- 3.12 Accesses 101-110 form part of the Shared Cable Route Corridor between the Scheme, Gate Burton Scheme and West Burton Scheme. If the construction periods for the respective schemes overlap, including within the Shared Cable Route Corridor, a Joint Construction Traffic Management Plan (Joint CTMP) could be produced. This will set out construction traffic management and control measures relevant to those areas where the construction vehicle routes for the respective schemes overlap, to reduce and manage any potential cumulative effects.



## 4 Construction Vehicle Trip Generation

4.1 The section sets out the trip generation associated with the construction, operation and decommissioning phase of the Scheme.

### Cottam 1, 2, 3a and 3b - HGVs

4.2 **Table 4.1** sets out a summary of the HGV movements that will be associated with the construction phase of the Scheme. The vast majority of deliveries by HGV will be by 16.5m articulated vehicles or 8-10m rigid vehicles. However, there will be a small number of abnormal load deliveries associated with the substation transformers. Abnormal load movements are discussed separately in **Section 6**.

4.3 It is expected that there will be a relatively flat profile of deliveries throughout the construction period. Therefore, an average number of deliveries per day has been calculated based on the length of the construction period. A 50% uplift on these numbers has been applied to provide a forecast of the peak number of daily deliveries.

Table 4.1 Cottam 1, 2, 3a and 3b: Anticipated Construction Deliveries (HGV)

Construction Activity	Vehicle Size (Max)	Cottam 1			Cottam 2	Cottam 3A	Cottam 3B	Total
Construction Period (Working Days)		529	440	337	251	242	178	529
Modules and Mounting Structures	16.5m Articulated	1,490	990	310	530	660	340	4,320
Conversion Units	16.5m Articulated	30	20	10	10	10	10	90
Access Track	10m Tipper	670	440	140	200	250	100	1,800
General (Fencing, Landscaping, etc.)	10m Rigid	1,280	850	260	480	580	350	3,800
Energy Storage Facility	16.5m Articulated	0	0	3,000	0	0	0	3,000
Total		3,470	2,300	3,720	1,220	1,500	800	13,010
Average per Day		7	5	11	5	6	4	38
Total Movements (Arrivals + Departures)		6,940	4,600	7,440	2,440	3,000	1,600	26,020
Average Movements per Day		14	10	22	10	12	8	76
Average Arrivals per Day (Peak Period – Plus 50%)		10	8	17	7	9	7	58
Average Movements per Day (Peak Period – Plus 50%)		20	16	34	14	18	14	116

### Cottam 1, 2, 3a and 3b - Cars/LGVs

- 4.4 On an average day, there is expected to be 450 workers spread across the Site. During the peak periods this could increase to around 600 construction workers. In addition, there will be approximately 50 workers positioned at the Energy Storage Facility in Cottam 1 (West).
- 4.5 A Construction Worker Travel Plan has been prepared. This is shown in **Appendix D**. This is discussed further in Section 9. The Travel Plan includes a measure for the provision of shuttle buses to transport construction workers to and from the Site. This is particularly important for non-local workers, who will stay in local accommodation and be transported to the Site. It can also be utilised by other workers as appropriate. It is expected that a mixture of coaches and minibuses will be used. On average, it is expected that a shuttle bus will be able to accommodate 20 workers. In addition, workers who drive will be encouraged to car share where possible.
- 4.6 With this in mind, it is assumed that 50% of workers will arrive by shuttle bus. The remainder will arrive by car with an assumed 1.5 construction workers per car.
- 4.7 Based on 650 construction workers (including 50 at the Energy Storage Facility), the forecast number of cars/LGVs are set out in Table 4.2.

Table 4.2 Construction Workers

Construction Activity	Cottam 1, 2, 3a and 3b
Construction Workers (Busy Day)	650
Shuttle Bus	16*
Car	217*
Total (Arrivals)	233
Total Movements (Arrivals + Departures)	466

\*Rounded to nearest number

### Construction Phase: Cable Route Corridor

- 4.8 For the construction of the Cable Route Corridor, 31 temporary accesses are required, approximately one every kilometre. It is forecast that each access will generate up to eight arrivals and eight departures per day for the delivery of material and equipment. Around half of these will be HGV trips and half LGV trips. There will also be around 10 construction workers per access, arriving by car and shuttle bus. Therefore, the cable route corridor will generate the following trips per day:

- Material and equipment:
  - HGV – 16 deliveries (32 movements) spread over four accesses;
  - LGV - 16 deliveries (32 movements) spread over four accesses;
- Construction worker arrivals (car or shuttle bus) – 40 arrivals (80 movements) spread over four accesses. As there are fewer construction workers than for the solar array sites, spread over a number of accesses, it is assumed that all workers will arrive by private car as a worst-case scenario.

4.9 HGV trips will largely consist of 10m tipper trucks. However, there will be a number of abnormal load movements associated with cable drum deliveries. This is discussed further in **Section 6**.

### Timings of Construction Vehicle Movements

4.10 Deliveries by HGV will be coordinated through a booking system to avoid travel during the network peak hours, where possible. Therefore, deliveries will be scheduled for between 09:30 and 16:30 where possible.

4.11 Construction worker shifts will be schedule so that workers are not traveling during the network peak hours of 08:00-09:00 and 17:00-18:00.

4.12 Therefore, there should be limited or no construction vehicle movement between 08:00-09:00 and 17:00-18:00.

### Summary

4.13 On a peak day during the construction phase, the following movements could be generated:

- Cottam 1, 2, 3a and 3b
  - HGV – 58 (116 total movements)
  - Car/Shuttle associated with construction workers – 233 (466 total movements)
- Cable Route Corridor
  - HGV – 16 (32 total movements)
  - LGV – 16 (32 total movements)
  - Car/Shuttle associated with construction workers – 40 (80 total movements)

## 5 Construction Vehicle Routing

5.1 This Section provides details of the construction vehicle routes to each access of the Scheme. Drivers will be made aware of the routes to each access in advance of driving to the Site. The selected routes are considered the most appropriate to each access.

### Cottam 1

5.2 Cottam 1 the largest area of the Scheme, and is split into three areas:

- Cottam 1 South;
- Cottam 1 North; and
- Cottam 1 West (to include the Energy Storage Facility).

5.3 All vehicles will arrive from the A15 to the east of the Site.

#### *Cottam 1 South*

5.4 The construction vehicle route for Cottam 1 South is shown in **Figure 5.1**

Figure 5.1 Cottam 1 South Construction Vehicle Route

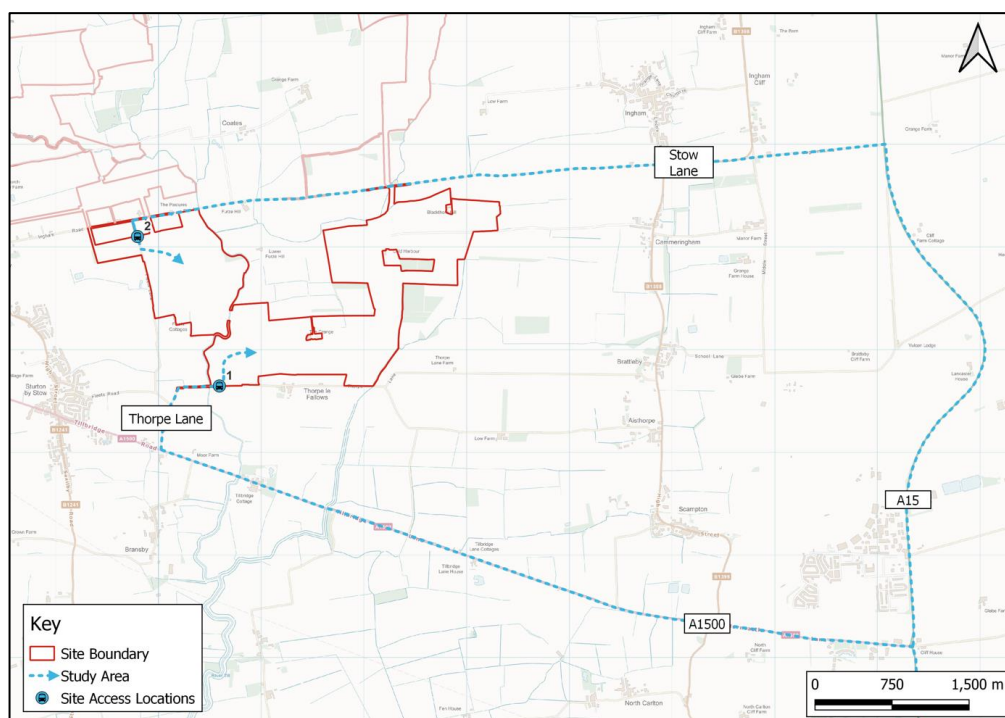

5.5 The routes to the two construction accesses that make up Cottam 1 South are:

- **Access 1 - Thorpe Lane:** A15 → A1500 Till Bridge Lane → Thorpe Lane
- **Access 2 - Fleets Lane:** A15 → Ingham Lane/Stow Lane/Ingham Road → Fleets Lane

### Cottam 1 North

5.6 The construction vehicle route for Cottam 1 North is shown in **Figure 5.2**

Figure 5.2 Cottam 1 North Construction Vehicle Route

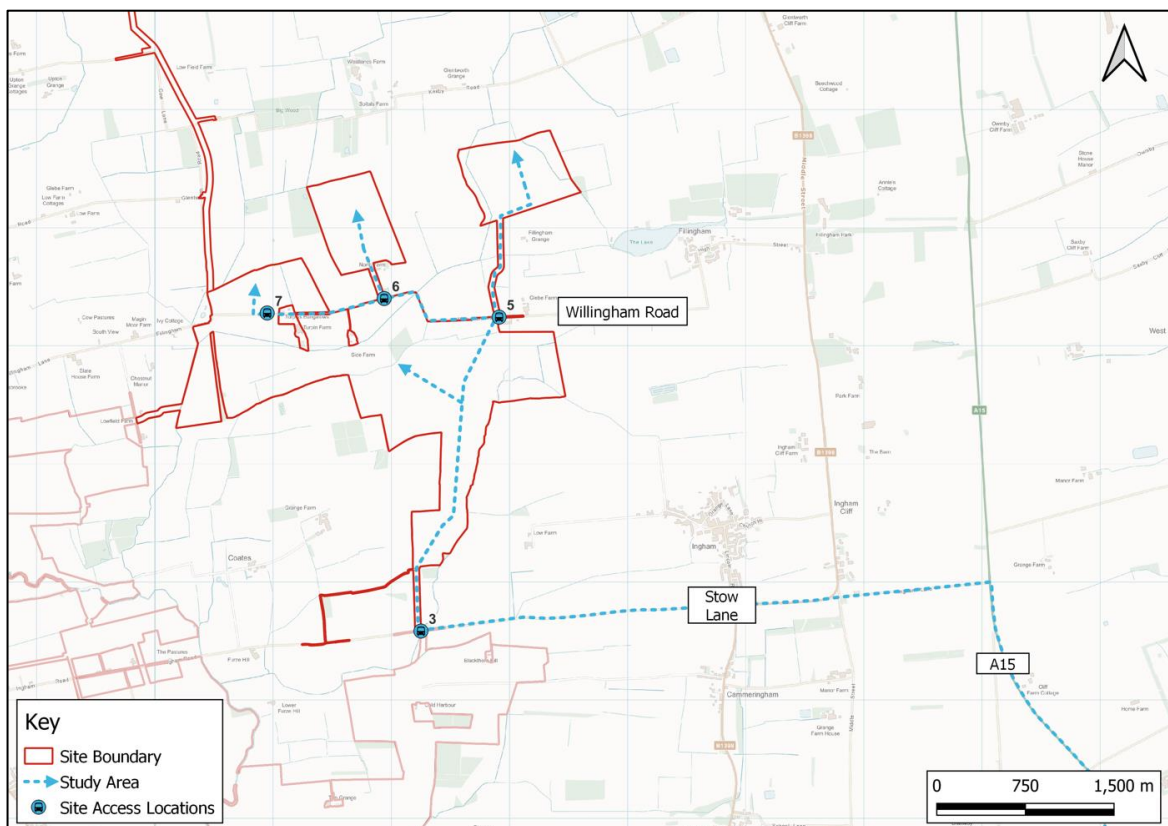

5.7 The routes to the four construction accesses that make up Cottam 1 North are:

- **Access 3 - Stow Lane:** A15 → Ingham Lane/Stow Lane/Ingham Road
- **Access 5, 6 and 7 – Willingham Road:** A15 → Ingham Lane/Stow Lane → Internal Access Track → Willingham Road

## Cottam 1 West

5.8 The construction vehicle route for Cottam 1 West is shown in **Figure 5.3**.

Figure 5.3 Cottam 1 West Construction Vehicle Route

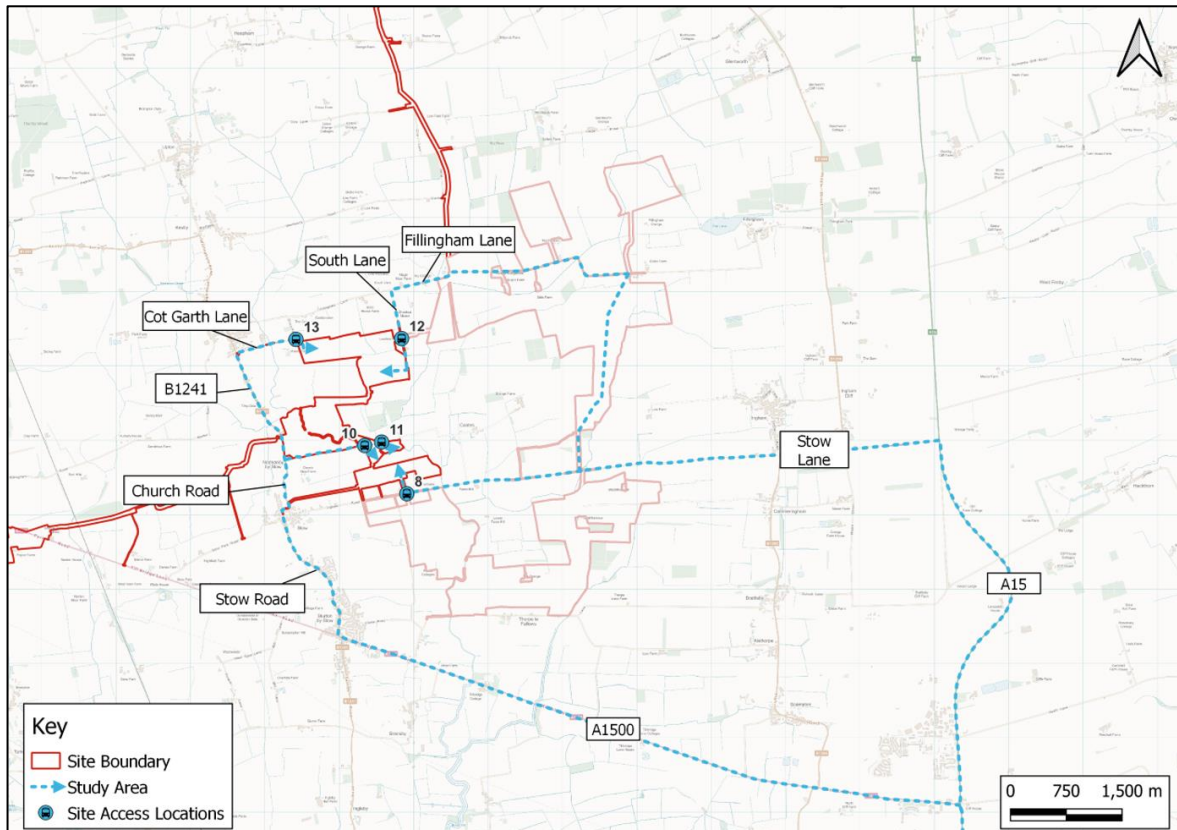

5.9 The routes to the five construction accesses that make up Cottam 1 West are:

- **Access 9 - Ingham Road:** A15 → Ingham Lane/Stow Lane/Ingham Road → Access;
- **Access 10 and 11 – Coates Lane:** A15 → A1500 Till Bridge Lane → Stow Road/Church Road → Coates Lane;
- **Access 12 – South Lane:** A15 → Ingham Lane/Stow Lane → Internal Access Track → Willingham Road → South Lane; and
- **Access 13 – Stone Pit Lane (Abnormal Loads):** A15 → A1500 Till Bridge Lane → B1241 → Cot Garth Lane → Stone Pit Lane.

## Cottam 2

5.10 The construction vehicle route for Cottam 2 is shown in **Figure 5.4**

Figure 5.4 Cottam 2 Construction Vehicle Route

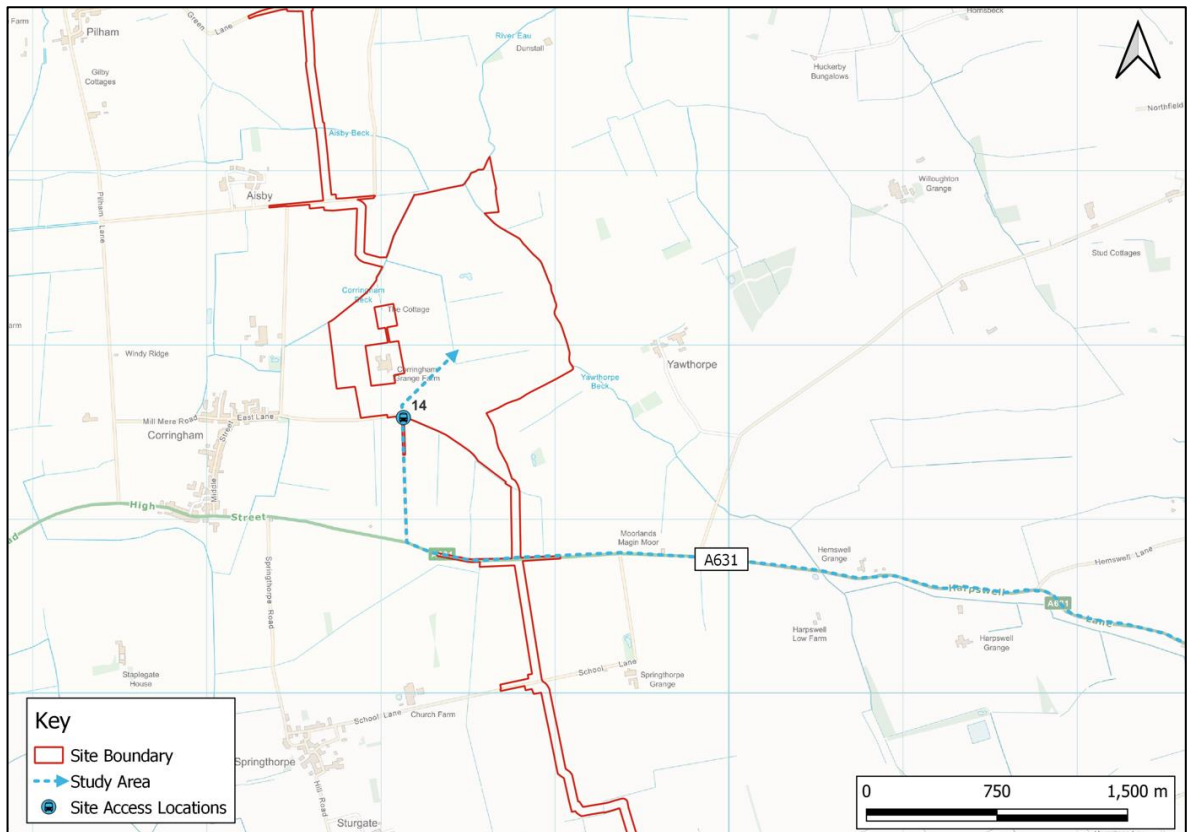

5.11 The route to the construction access for Cottam 2 is:

- **Access 14 – A631:** A15 → A631 → Access Road → Site

### Cottam 3a

5.12 The construction vehicle route for Cottam 3a is shown in **Figure 5.5**



Figure 5.5 Cottam 3a Construction Vehicle Route

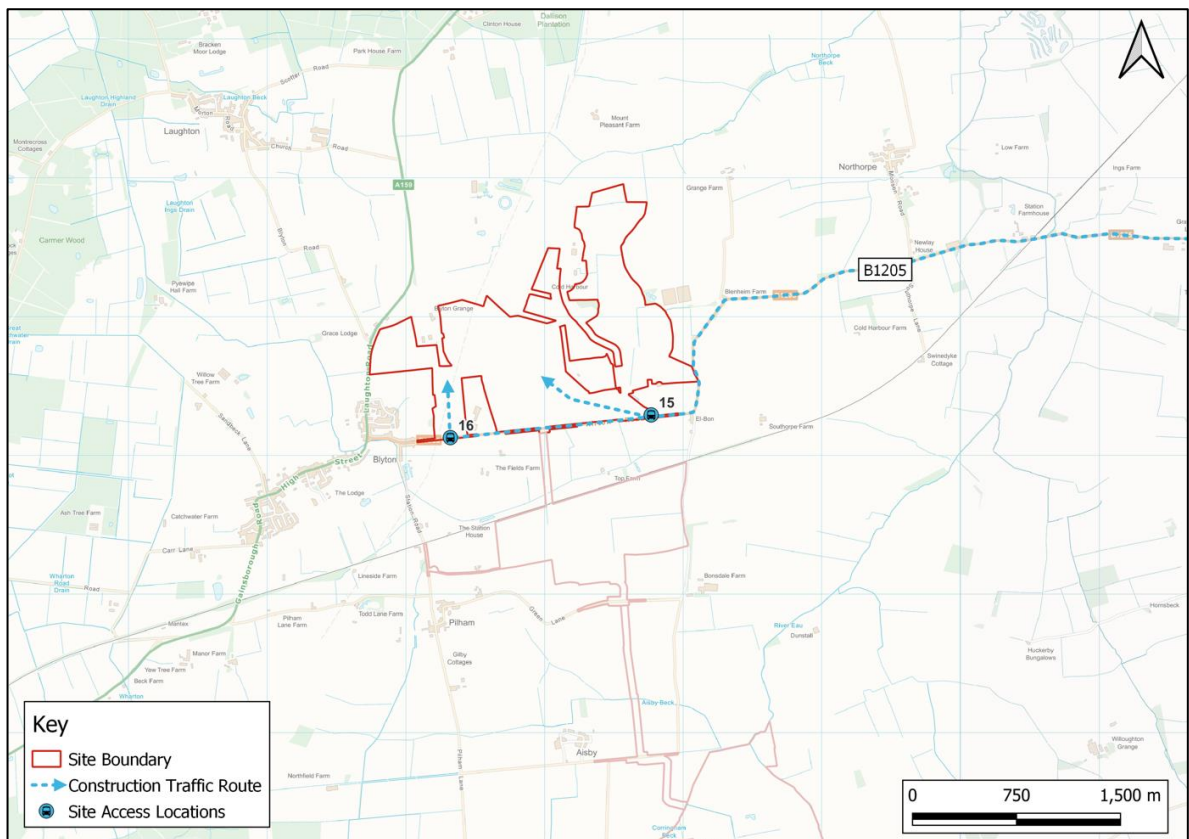

5.13 The route to the construction accesses that make up Cottam 3a is:

- **Access 15 and 16:** A15 → B1205 Kirton Road → Accesses

### Cottam 3b

5.14 The construction vehicle route for Cottam 3b is shown in **Figure 5.6**.

Figure 5.6 Cottam 3b Construction Vehicle Route

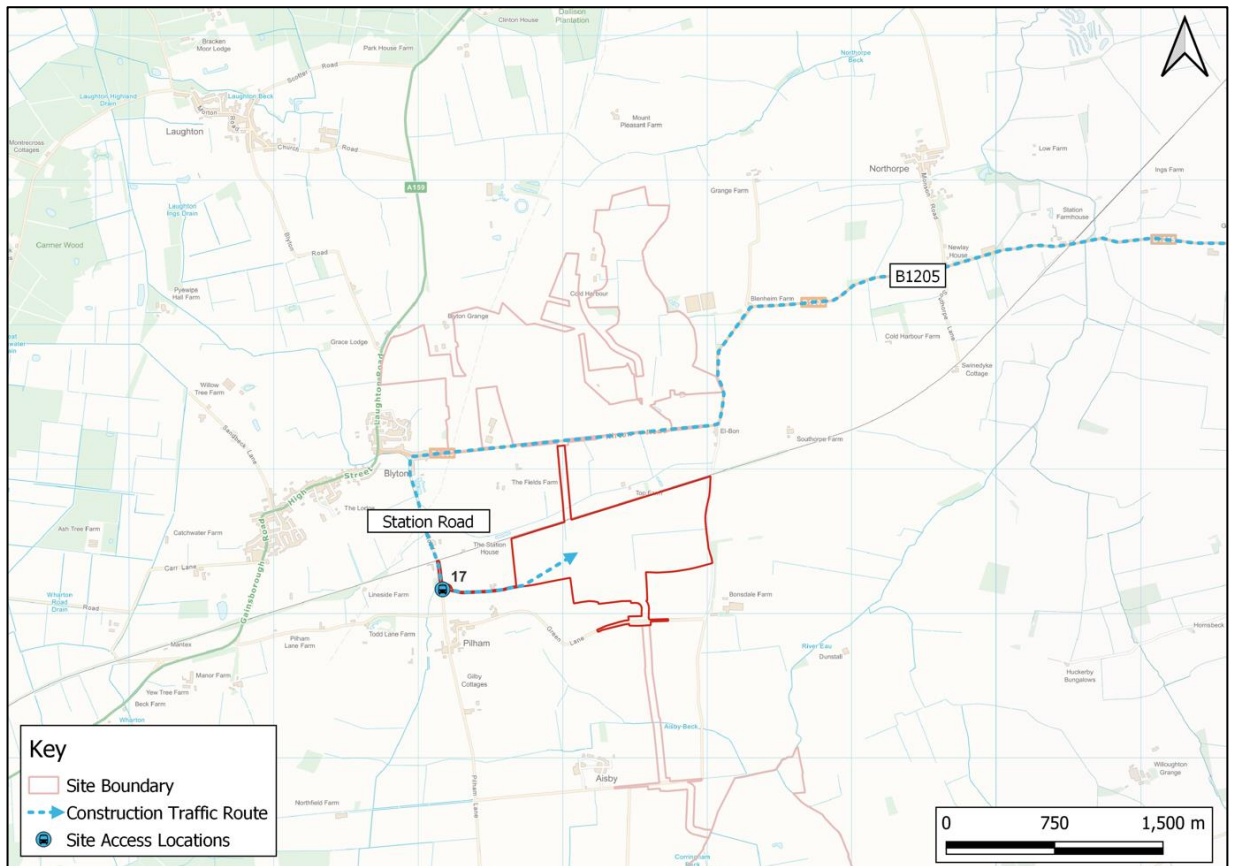

5.15 The route to the construction accesses that make up Cottam 3b is:

- **Access 17:** A15 → B1205 Kirton Road → Station Road → Accesses

### Cable Route Corridor

5.16 A summary of the construction vehicle routes for each access for the Cable Route Corridor is set out below and shown in **Figure 5.7**

- **Grid Connection Access 101:** A57 → Laneham Road → Cottam Road → Via Access 102 internal track;
- **Grid Connection Access 102 and 103:** A57 → Laneham Road → Cottam Road
- **Grid Connection Access 105 and 106:** A57 → Laneham Road → Cottam Road Headsted Bank;
- **Grid Connection Access 107 and 108:** A57 → A156 High Street south of Marton;
- **Grid Connection Access 109, 110, 111 and 112:** A15 → A1500 Till Bridge Lane;
- **Grid Connection Access 113:** A1500 Till Bridge Lane → Stow Park Road;
- **Grid Connection Access 114 and 115:** A1500 Till Bridge Lane → B1241;
- **Grid Connection Access 116 and 117:** Through Cottam 1 Site → South Lane;
- **Grid Connection Access 118:** Through Cottam 1 Site → Willingham Road;
- **Grid Connection Access 119:** B1241 → Glentworth Road;

- **Grid Connection Access 120 and 121:** A631 → Middle Street → Kexby Road;
- **Grid Connection Access 122 and 123:** A631 → Common Lane;
- **Grid Connection Access 124 and 125:** A631 → School Lane;
- **Grid Connection Access 126 and 127:** A631 (Lincolnshire);
- **Grid Connection Access 128 and 129:** A631 → Pilham Lane (Lincolnshire);
- **Grid Connection Access 130 and 131:** B1205 → Station Road → Pilham Lane;
- **Grid Connection Access 132:** B1205 Kirton Road;

Figure 5.7 Cable Route Corridor Construction Vehicle Route

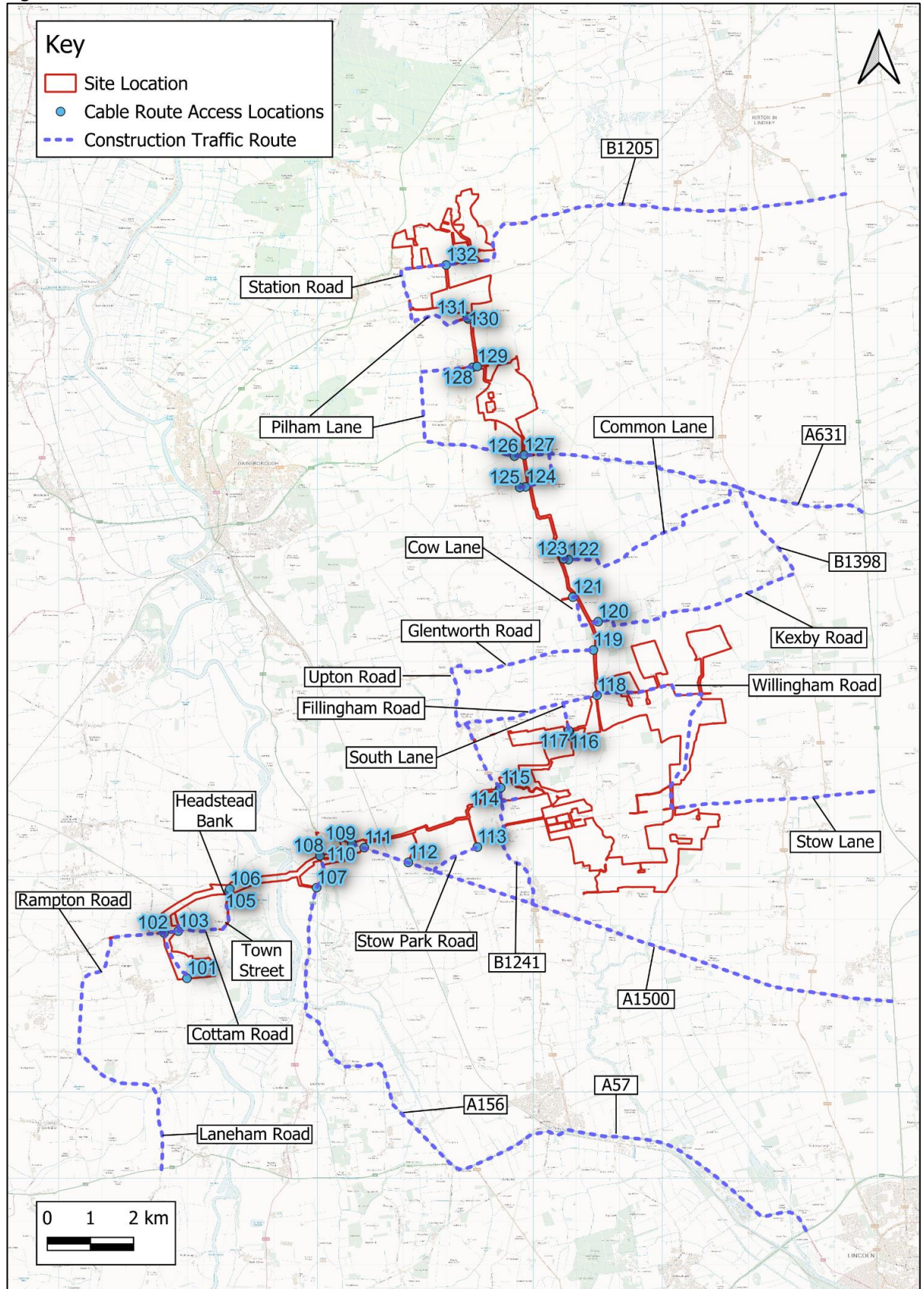

## Route Signage

- 5.17 Temporary road signing will be implemented along the designated routes to inform background traffic of the ongoing construction works and to direct construction traffic to and from the Site. The signs will be located at key points along the route, including junctions.
- 5.18 All signage will be compliant with Chapter 8 of the Traffic Signs Manual where applicable. The following points will be considered when locating signage:
- The position of the sign in relation to the highway;
  - Possible distraction to drivers; and
  - The proximity to junctions and roundabouts.
- 5.19 The signage strategy will be agreed with the local highway authority through the final CTMP.

## Management of Deliveries

- 5.20 Due to the relatively low number of vehicles associated with the construction phase there is not anticipated to be any significant delay to background traffic.
- 5.21 All deliveries will be scheduled in advance using a booking system. Drivers will be instructed to stop in an appropriate layby and make contact if they are likely to miss their allotted slot to allow the schedule to be adapted in as much as possible. The intention of this procedure is to avoid instances of HGVs passing each other in opposite directions on the local roads surrounding the Site.

### *Procedure for Arrival to Site*

- Drivers to be notified of scheduled arrival time ahead of delivery to the Site and which access/route to use;
  - When the delivery vehicle is due the banksmen will be mobilised and will go to position at the relevant Site access;
  - The driver will be informed that the operators are in place and it is appropriate to travel to the Site via the agreed route;
  - All operatives will communicate with each other, as necessary; and
  - Banksmen will assist HGV's to manoeuvre from the public highway into the Site accesses, but will not direct general traffic.
- 5.22 The following procedure will be initiated when HGVs are leaving the Site:

### *Procedure for Leaving the Site*

- Before drivers depart, the Site Manager will be notified. They will then mobilise the banksmen at the relevant Site access;

- Drivers will be advised when the banksmen are in place; and
- Banksmen will guide the drivers exiting the Site on to the public highway.

5.23 Mitigation measures will be provided throughout the construction phase and are discussed in more detail in **Chapter 7**.

## 6 Abnormal Loads

- 6.1 There will be a number of abnormal load movements associated with the construction of the Scheme.
- 6.2 Abnormal load specialists ‘Wynns’ have prepared a report detailing the required movements. This is shown in **Appendix F** of the **Transport Assessment (ES Appendix 14.1)**.

### Trip Generation and Access

#### *Cottam 1, 2, 3a and 3b*

- 6.3 The Abnormal Load movements associated with the substations and their access are summarised in Table 6.1.

Table 6.1 Abnormal Load Movements

Substation Location	Transformer Dimensions (Length/Width/Height)	Vehicle Type	Access	Frequency
Cottam 1	7.24m/5.00m/4.78m 157 tonnes	16 axle girder frame (approx. 70m in length)	Stone Pit Lane (Access 13)	5
Cottam 2	7.90m/4.86m/4.50m 100 tonnes	5 axle bed with 5 axle draw bar trailer (approx. 36m in length)	A631 (Access 14)	2
Cottam 3a	7.90m/4.86m/4.50m 100 tonnes	5 axle bed with 5 axle draw bar trailer (approx. 36m in length)	Kirton Road (Access 16)	2
Cottam 3b	7.90m/4.86m/4.50m 100 tonnes	5 axle bed with 5 axle draw bar trailer (approx. 36m in length)	Station Road (Access 17)	1

#### *Cable Route Corridor*

- 6.4 The 30 tonne cable drum will be delivered on a Cable Reel Trailer. This vehicle is classified as an abnormal load. However, the vehicle is not nearly as big as those required to deliver the transformers at 26m in length.

- 6.5 Each section of the Cable Route will require around 100 cable drum deliveries (around 25 per access).
- 6.6 The Cable Reel Trailer and vehicle will get as close to the relevant access location as possible. From here, the cable drum will be unloaded and towed along the haulage road to the appropriate location for installation. This will be managed through banksmen and/or traffic marshalls.

## Routes for Abnormal Load Movements

### *Cottam 1, 2, 3a and 3b*

- 6.7 Loads will be transported by river to the Immingham Docks. From here they will use the A160, A180 and M180 to reach the A15. From the A15, the routes to the relevant substations within each Site are as follows:
- **Cottam 1:** A15 → A1500 Till Bridge Lane → Stow Road/Church Road → B1241 → Cot Garth Lane → Stone Pit Lane Access;
  - **Cottam 2:** A15 → A631 → Access Road;
  - **Cottam 3a:** A15 → B1205 Kirkton Road → Access;
  - **Cottam 3b:** A15 → A631 → Pilham Lane → Station Road → Access.
- 6.8 These routes are shown in **Figure 6.1**



Figure 6.1 Abnormal Load Movements

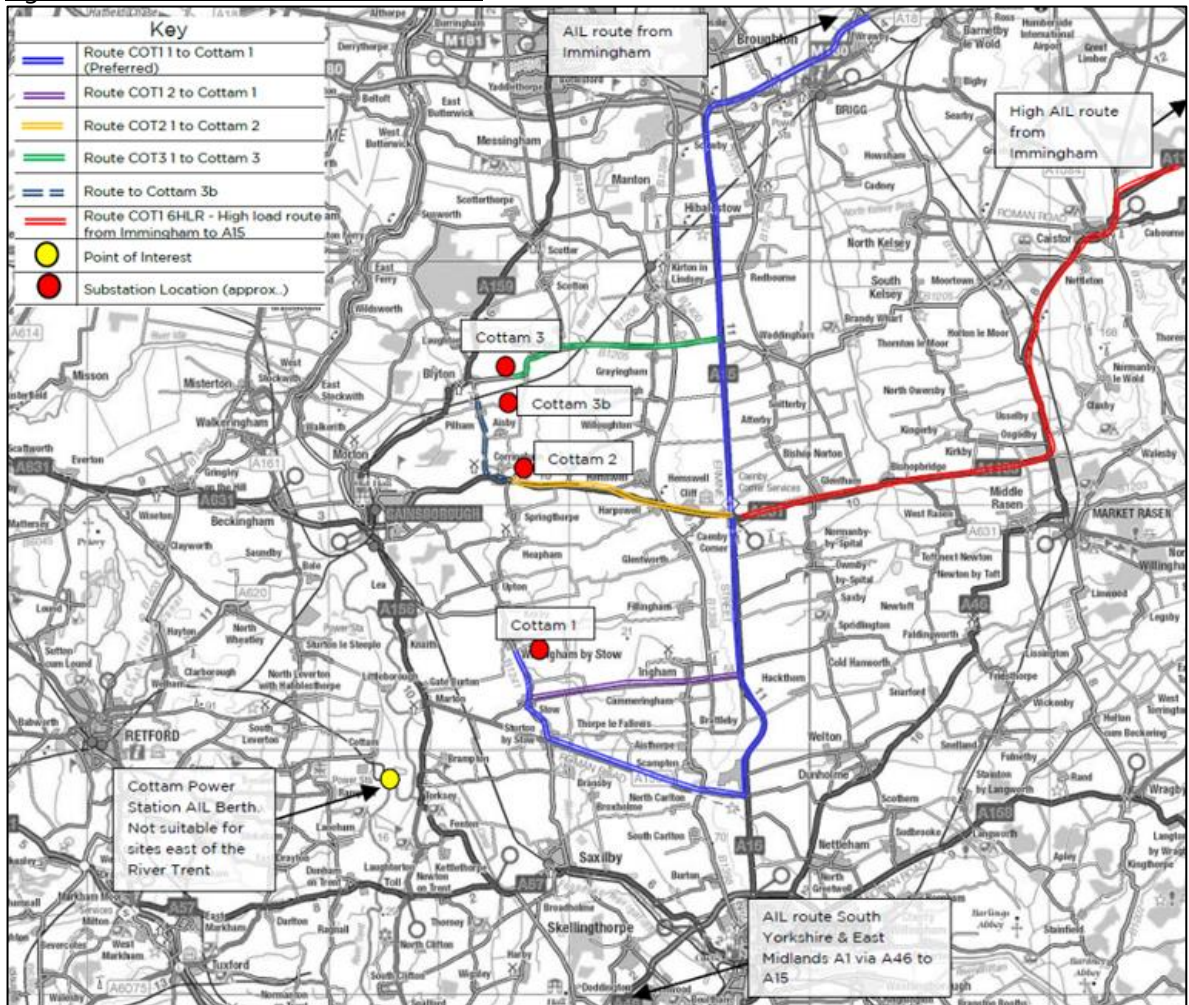

*Cable Route Corridor*

6.9 Wynns has undertaken analysis of the routes to the Cable Route Corridor, as set out Section 6. This is shown within their report at **Appendix F** of the **Transport Assessment (ES Appendix 14.1)**. They have concluded that all accesses are accessible by the Cable Reel Trailer except Accesses 122 and 123. Therefore, these will not be used for abnormal load movements.

**Management and Measures**

*Cottam 1, 2, 3a and 3b*

6.10 Traffic management will be in places for all 10 abnormal load movements destined for the Sites.

*“AILs will take up the entire road width on the final approaches to all sites and careful traffic management will need to be agreed with Lincolnshire Police in terms of escort requirements. It is possible that detailed traffic management options including Temporary Traffic Regulation*

*Orders (TTRO) will be required by the police or highway authority although no such requirement has been highlighted as necessary to date in their responses to the route enquires. It will be agreed by the appointed haulage contractor prior to movement”.*

- 6.11 The exact nature of the traffic management will be agreed with the local highway authority and police prior to the movement taking place.
- 6.12 For the structure reviews, should any issue arise, the following measures will be explored (Wynns Report Paragraph 9.18);
- Alternative trailer arrangements to spread the load;
  - Temporary or permanent relieving measures.
- 6.13 Where appropriate, the temporary laying of steel plates or timbers will be undertaken to protect verges and kerbs.
- 6.14 To access Cottam 1, the AIL movements will travel near to the Schedule Site of a College and Benedictine Abbey, St Mary's Church, on the B1241 in Stow. During the AIL movements, suitably qualified banksmen will be positioned alongside the boundary wall of St Mary's Church to oversee AIL manoeuvres and ensure that there is no direct impact to the wall. The banksmen will be provided with a toolbox talk to explain the significance of the Scheduled Monument.

### *Cable Route Corridor*

- 6.15 Traffic management will also be in place for abnormal load movements associated with the Cable Route Corridor. Again, the exact nature of the traffic management will be agreed with the local highway authority and police prior to the movement taking place.

## 7 Construction Traffic Mitigation and Management Measures

7.1 The contractor will introduce measures to minimise the impact resulting from construction activities. It will be the responsibility of the Project Manager and Site Manager to oversee the implementation of the mitigation and management measures.

7.2 The measures are set out below.

### Public Rights of Way

- (i) A Public Right of Way Management Plan will be implemented during the construction phase of the Scheme. An Outline Public Right of Way Management Plan is included at **Appendix 14.3** of the **Environmental Statement** [EN010133/APP/C6.3.14.3]. Where a vehicle track crosses a Public Right of Way, the following measures will be implemented:
- A widened access track to ensure vehicles can pass PRoW users safely (including cyclists and equestrians);
  - The provision of banksmen at either end of the PRoW, to hold vehicles if a PRoW user is present and advise PRoW users of the potential for construction vehicles to be present;
  - Speeds to be limited to 10mph;
  - Drivers will stop and give-way to any PRoW user (in particular for equestrians) that they encounter;
  - Appropriate signage will be installed along the PRoW to make PRoW users aware of the construction activity. This will include information on construction times and contact details for a public liaison officer;
  - The PRoW will be kept clear of construction vehicles and apparatus outside of permitted construction hours so far as is practicable to do so;
    - Any damage to the surface of the footpath/bridleway will be repaired as soon as practicable. The surface will be returned to its original condition following completion of construction.

### Specific Highway Measures

- (ii) Where existing accesses are utilised, these will be widened and formalised as appropriate. Visibility splays will be kept clear throughout the construction period;
- (iii) On narrower sections on the highway, in particular on Willingham Road, temporary pass-by bays will be created.

## Traffic Management

- (iv) For the duration of the construction phase, it is recommended that sector approved traffic marshals are positioned at the B1205/B1398 crossroad as this is an identified accident hotspot. The exact nature of the traffic management in this location will be agreed with the local highway authority and police prior to construction commencing.
- (v) Traffic management for abnormal load movements will be agreed with the local highway authority and police prior to the abnormal load movements taking place.

## Signage

- (vi) Signs to direct construction vehicles associated with the development will be installed along the construction traffic route. Delivery drivers, contractors and visitors will be provided with a route plan in advance of delivering to Site to ensure that vehicles follow the identified route. The signage strategy will be agreed with the local highway authorities prior through the Final CTMP;
- (vii) All signage on the designated route will be inspected daily by the Site Manager, to ensure they are kept in a well maintained condition and located in safe and appropriate locations;

## Vehicle Movement

- (viii) Construction deliveries by HGV will be coordinated to arrive/depart between 09:30-16:30 to avoid the network peak hours of 08:00-09:00 and 17:00-18:00.
- (ix) Banksman will be provided at the Site accesses to indicate to construction traffic when it is safe for them to enter and exit the Site;
- (x) A Construction Worker Travel Plan will be implemented, to encourage construction workers to travel to the Site via sustainable travel, where possible. Measure include the provision of a shuttle bus and a car sharing scheme. Shifts will be organised to avoid construction worker movement between 08:00-09:00 and 17:00-18:00;
- (xi) The management associated with Abnormal Load movements will be agreed with the local highway authority and the police prior to the delivery;

## Booking System

- (xii) A booking system will be set up to manage arrivals and departures to the Site. A log will be kept as part of the booking system. The intention of this procedure is to avoid instances of HGVs passing each other in opposite directions on the local roads surrounding the Site.

## Parking

- (xiii) Advisory signs informing contractors and visitors that parking is not permitted on-street in the vicinity of the Site or on the Site access road. Contractors and visitors will be advised that parking facilities will be provided on-Site in advance of visiting the Site and that they should not park on-street;

## Wheel Wash Facility

- (xiv) A wheel washing facility will be provided at each access. This will be located at the end of each access road, ahead of the egress onto the local highway network;
- (xv) A visual inspection of vehicles will be undertaken before they depart the Site, to ensure that they are not carrying any residual debris onto the highway;
- (xvi) If required, a road sweeper will be provided for the area surrounding access to alleviate any residual debris generated during the construction phase, as required;

## Noise Reduction and Air Quality

- (xvii) When on Site and when not in use, vehicle engines will be switched off;
- (xviii) Vehicles carrying material off-Site will be sheeted to prevent the spread of dust;
- (xix) In dry conditions, areas near to the Site access will be sprayed with water supplied to prevent the spread of dust;

## Site Security

- (xx) The Site will be secured at all times via a perimeter fence or temporary fencing. CCTV will be operational within the construction compound. All new access tracks will be secured by gates, which will be set back from the public highway. Where existing access tracks are used that also provide access to residential properties, appropriate security measures will be put in place in consultation with the relevant property owner(s);

## Road Condition Survey

- (xxi) A pre-construction road condition survey will be carried out on the local highway network via video two weeks before the construction phase commences. The extent of the survey will be agreed with the local highway authority prior to commencement. Once construction is complete, a post-construction condition survey will be undertaken in order to identify any additional defects that can reasonably be attributable to construction activities at the Site. Any

identified highways defects resulting from construction activities associated with the Site will be corrected to the satisfaction of the local highway authority.

- (xxii) A separate road condition survey will be undertaken on any private road affected by the Scheme. Any identified defects in the private road resulting from construction activities will be corrected to the reasonable satisfaction of the owner.

### **Community Engagement**

- (xxiii) The details of the Construction Site Manager will be provided to the local highway authority in advance of any work being carried out.
- (xxiv) The Construction Site Manager's details will also be provided on a Site-board at the Site accesses. If anyone in the local community has any issues during the construction phase, the Site Manager will be available to discuss.

### **Monitoring**

- (xxv) Any unforeseen issues that arise in relation to construction vehicle movement will be logged by the Site Manager. If necessary, the issues will be discussed with the local highway authority so that they can be resolved as appropriate.

### **Joint CTMP**

- (xxvi) In the event that the construction schedules associated with this Scheme and other schemes in the area overlap (being the West Burton Solar Project and the Gate Burton Solar Project), a joint Construction Traffic Management Plan (Joint CTMP) could be produced. This would set out construction traffic management and control measures relevant to those areas where the construction vehicle routes for the schemes would overlap, to reduce and manage any potential cumulative effects. This is particularly relevant to the Shared Cable Route Corridor with the West Burton and Gate Burton projects. The Joint CTMP would be agreed with the relevant authorities prior to commencement of construction.

# FIGURES

**A3**

ORIGINAL  
PLOT SIZE

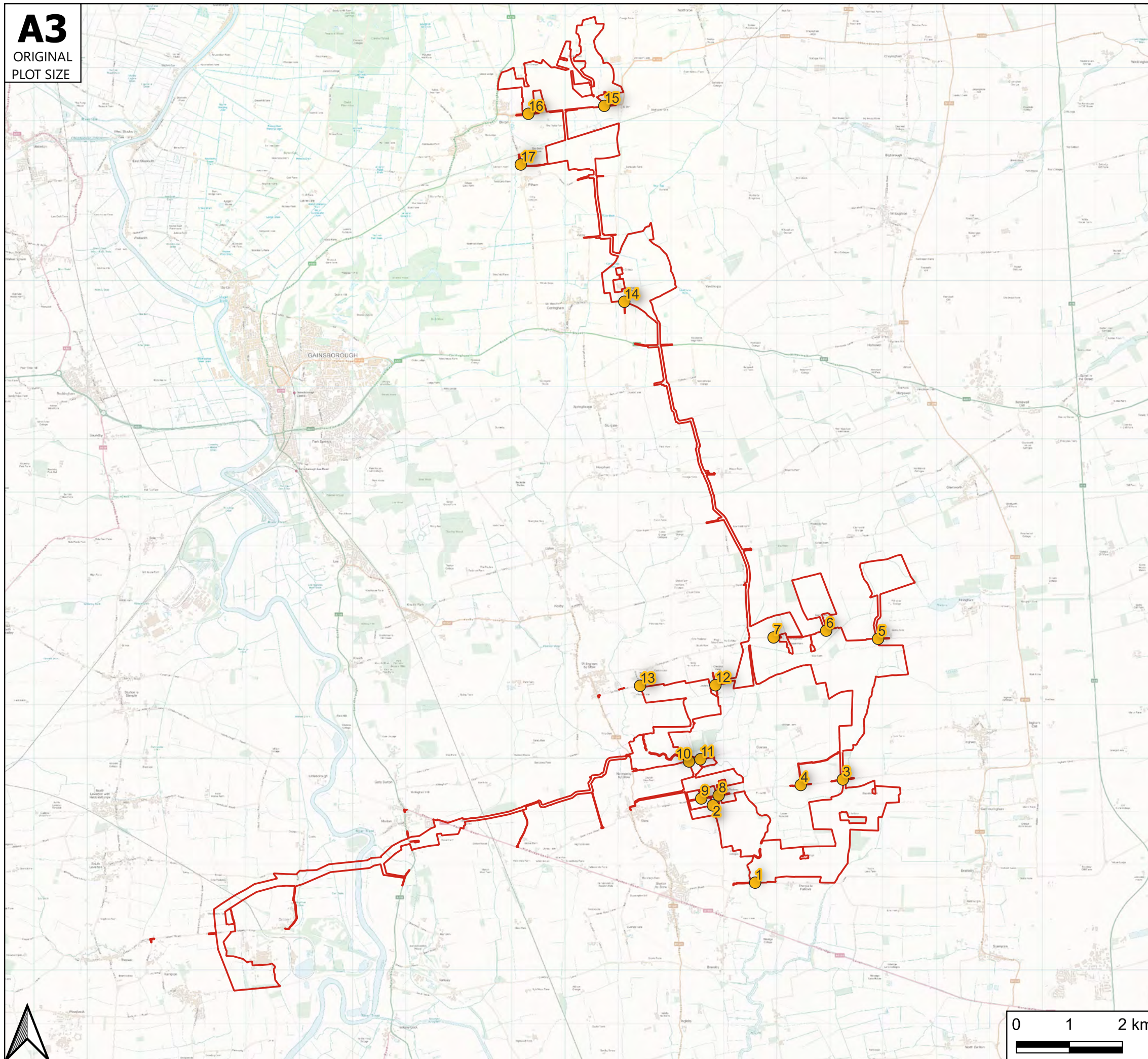

Reproduced from .....

**Key**

- Site Boundary
- Cottam Solar Farm Access Locations

Rev	Date	Details	Drawn by	Checked by	Approved by

Bristol  
Cambridge  
London  
Manchester  
Oxford  
Welwyn Garden City

25 King Street  
Bristol  
BS1 4PB

0117 925 9400  
[www.tpa.uk.com](http://www.tpa.uk.com)

CLIENT:  
**Cottam Solar Projects Limited**

PROJECT:  
**Cottam Solar Project**

TITLE:  
**Access Locations - Cottam 1, 2 and 3**

STATUS:  
**FOR INFORMATION**

SCALE: NTS	DATE: 14/12/22	DRAWN: AC	CHECKED: RR	APPROVED: JD
JOB NO: 2107-062		DRAWING NO: Figure 3.1		REVISION: -

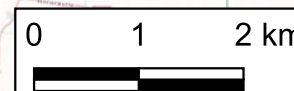



**A3**

ORIGINAL  
PLOT SIZE

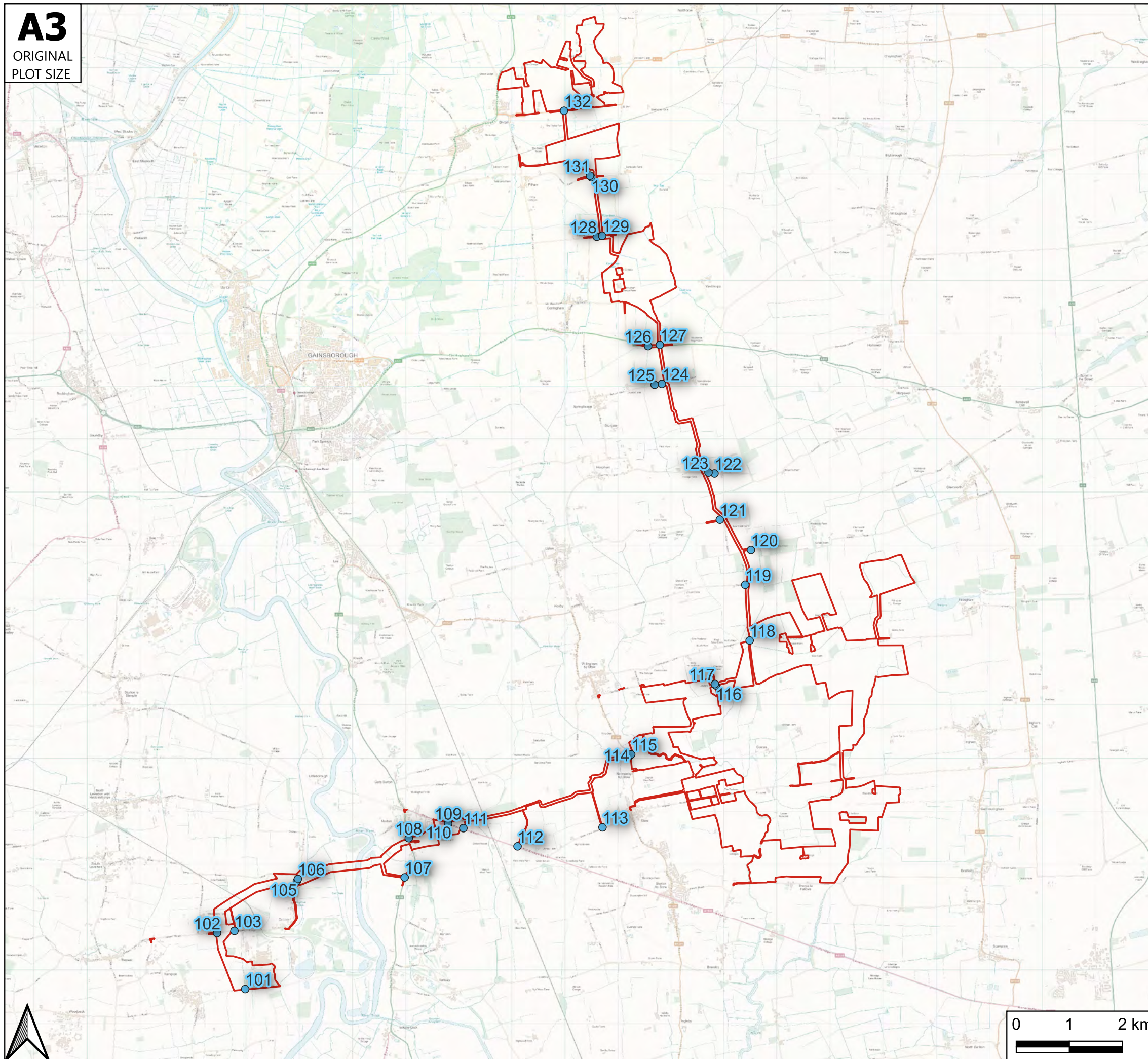

Reproduced from .....

**Key**

- Site Boundary
- Cable Route Access Locations

Rev	Date	Details	Drawn by	Checked by	Approved by

Bristol  
 Cambridge  
 London  
 Oxford  
 Welwyn Garden City



25 King Street  
 Bristol  
 BS1 4PB

0117 925 9400  
[www.tpa.uk.com](http://www.tpa.uk.com)

CLIENT:  
**Cottam Solar Projects Limited**

PROJECT:  
**Cottam Solar Project**

TITLE:  
**Access Locations - Cable Route Corridor**

STATUS:  
**FOR INFORMATION**

SCALE: NTS	DATE: 14/12/22	DRAWN: AC	CHECKED: RR	APPROVED: JD
JOB NO: 2107-062		DRAWING NO: Figure 4.2		REVISION: -

**A3**

ORIGINAL  
PLOT SIZE

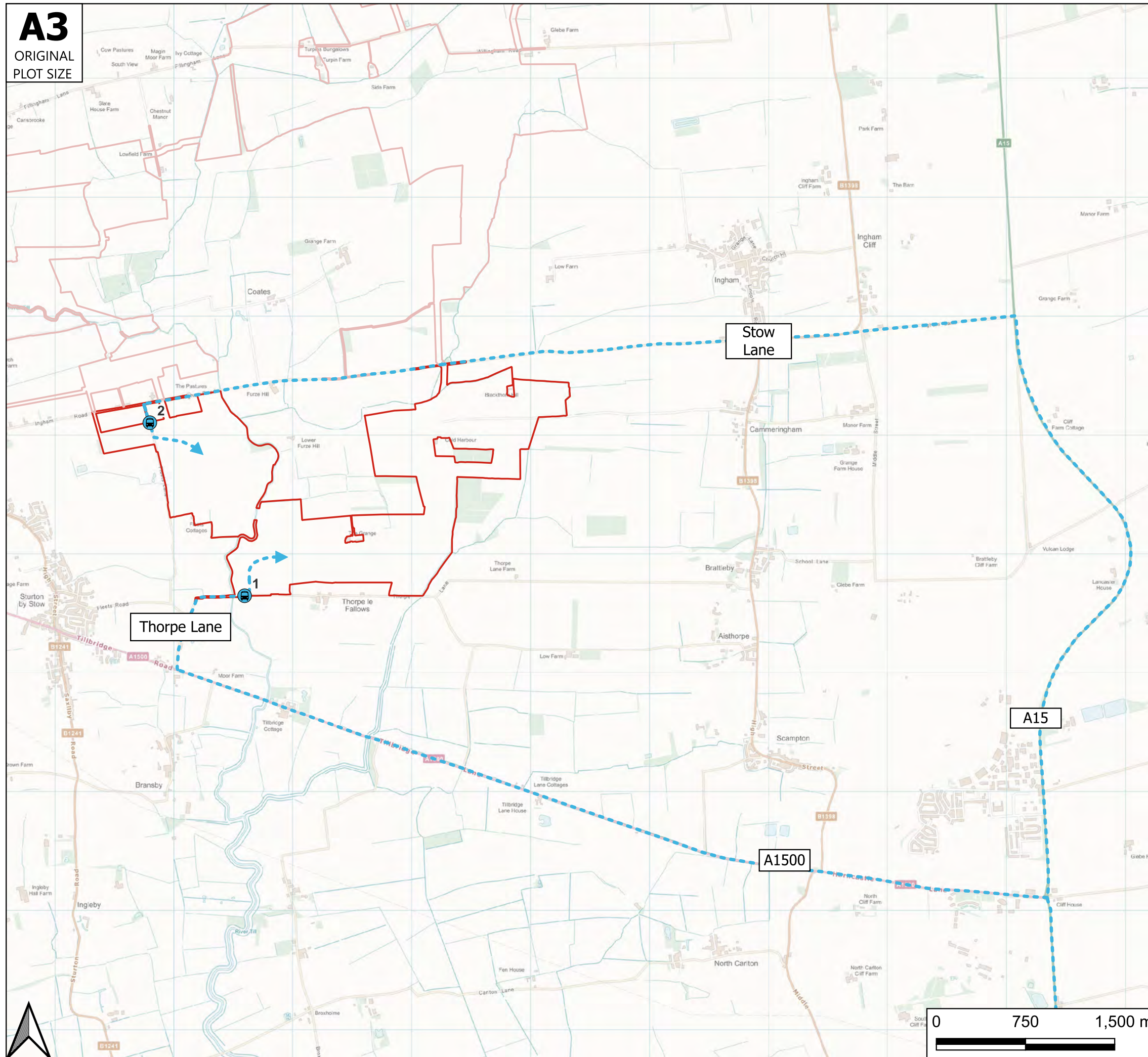

Reproduced from .....

**Key**

- Site Boundary
- Construction Traffic Route
- Site Access Locations

Rev	Date	Details	Drawn by	Checked by	Approved by

Bristol  
Cambridge  
London  
Oxford  
Welwyn Garden City



25 King Street  
Bristol  
BS1 4PB

0117 925 9400  
[www.tpa.uk.com](http://www.tpa.uk.com)

CLIENT:  
**Cottam Solar Projects Limited**

PROJECT:  
**Cottam Solar Project**

TITLE:  
**Construction Vehicle Route -  
Cottam 1 South**

STATUS:  
**FOR INFORMATION**

SCALE: NTS	DATE: 02/11/23	DRAWN: AC	CHECKED: RR	APPROVED: JD
JOB NO: 2107-062		DRAWING NO: Figure 5.1		REVISION: -

**A3**  
ORIGINAL  
PLOT SIZE

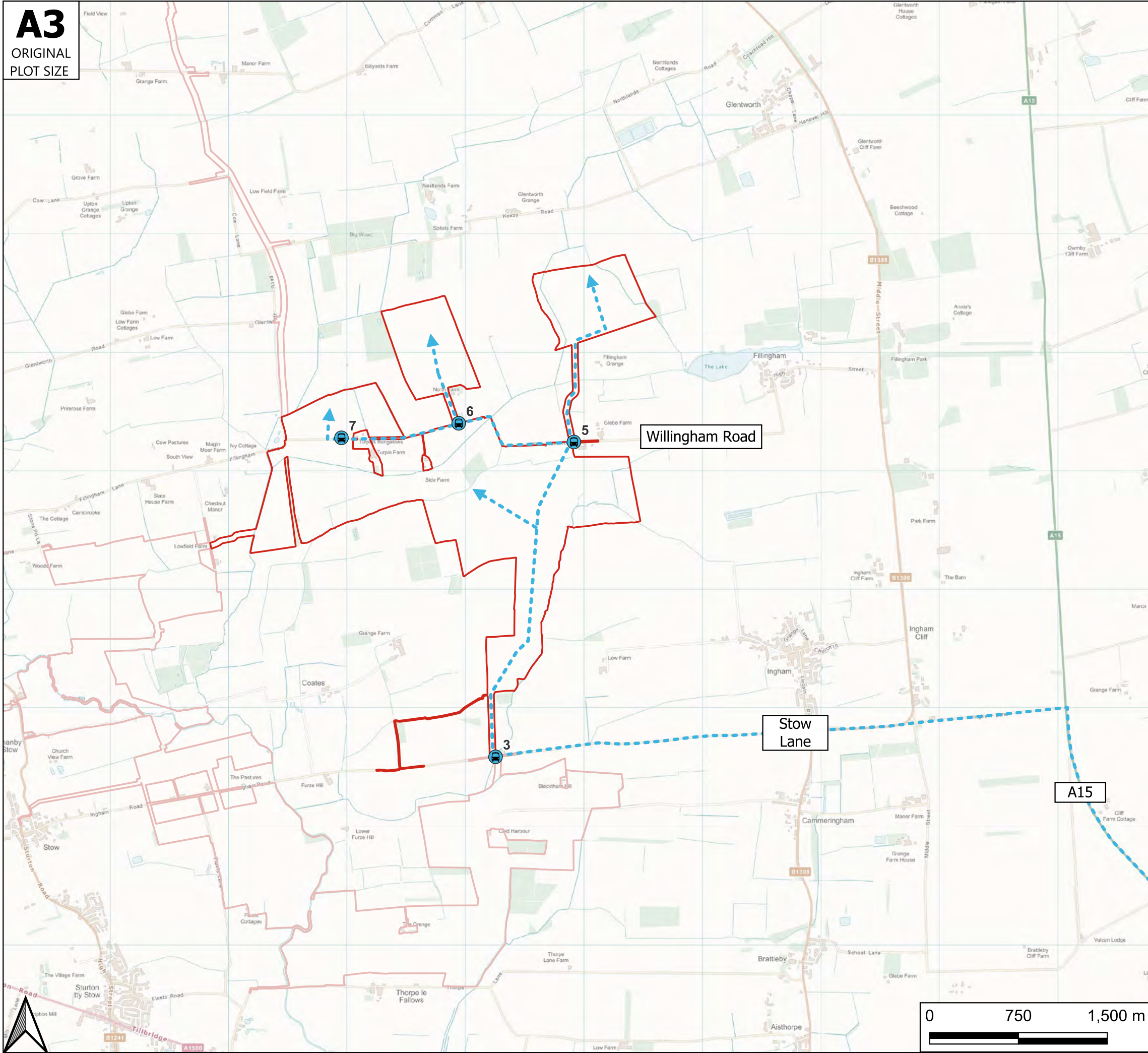

Reproduced from .....

**Key**

- Site Boundary
- - - ▶ Construction Traffic Route
- ⊙ Site Access Locations

Rev	Date	Details	Drawn by	Checked by	Approved by

Bristol  
Cambridge  
London  
Oxford  
Welwyn Garden City

Transport Planning Associates

25 King Street  
Bristol  
BS1 4PB

0117 925 9400  
[www.tpa.uk.com](http://www.tpa.uk.com)

CLIENT:  
**Cottam Solar Projects Limited**

PROJECT:  
**Cottam Solar Project**

TITLE:  
**Construction Vehicle Route -  
Cottam 1 North**

STATUS:  
**FOR INFORMATION**

SCALE: NTS	DATE: 02/11/23	DRAWN: AC	CHECKED: RR	APPROVED: JD
JOB NO: 2107-062		DRAWING NO: Figure 5.2		REVISION: -

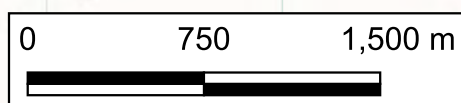

**A3**

ORIGINAL  
PLOT SIZE

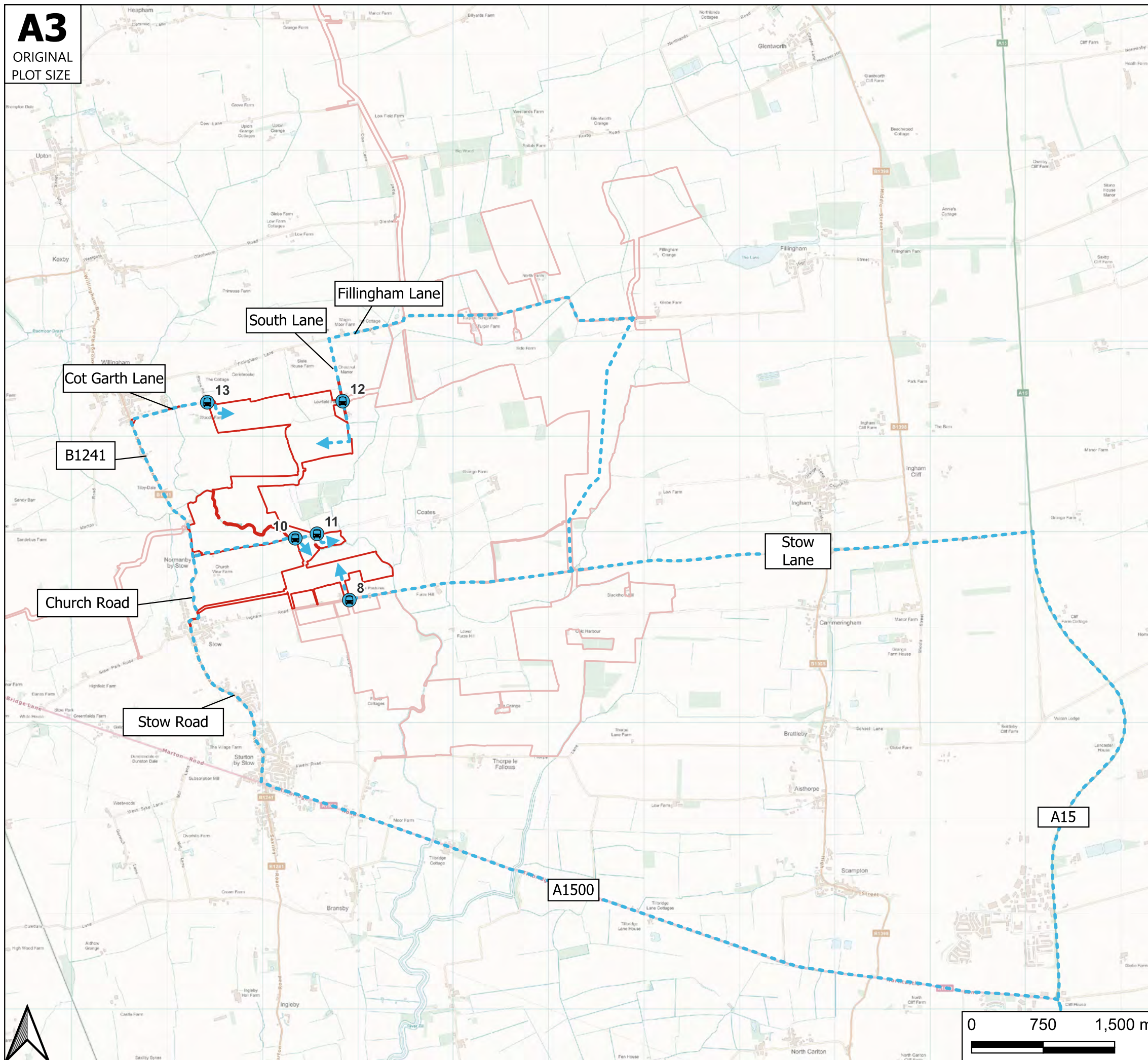

Reproduced from .....

**Key**

- Site Boundary
- - - Construction Traffic Route
- ⊙ Site Access Locations

Rev	Date	Details	Drawn by	Checked by	Approved by

Bristol  
Cambridge  
London  
Oxford  
Welwyn Garden City



25 King Street  
Bristol  
BS1 4PB

0117 925 9400  
[www.tpa.uk.com](http://www.tpa.uk.com)

CLIENT:  
**Cottam Solar Projects Limited**

PROJECT:  
**Cottam Solar Project**

TITLE:  
**Construction Vehicle Route -  
Cottam 1 West**

STATUS:  
**FOR INFORMATION**

SCALE: NTS	DATE: 02/11/23	DRAWN: AC	CHECKED: RR	APPROVED: JD
JOB NO: 2107-062		DRAWING NO: Figure 5.3		REVISION: -

**A3**  
ORIGINAL  
PLOT SIZE

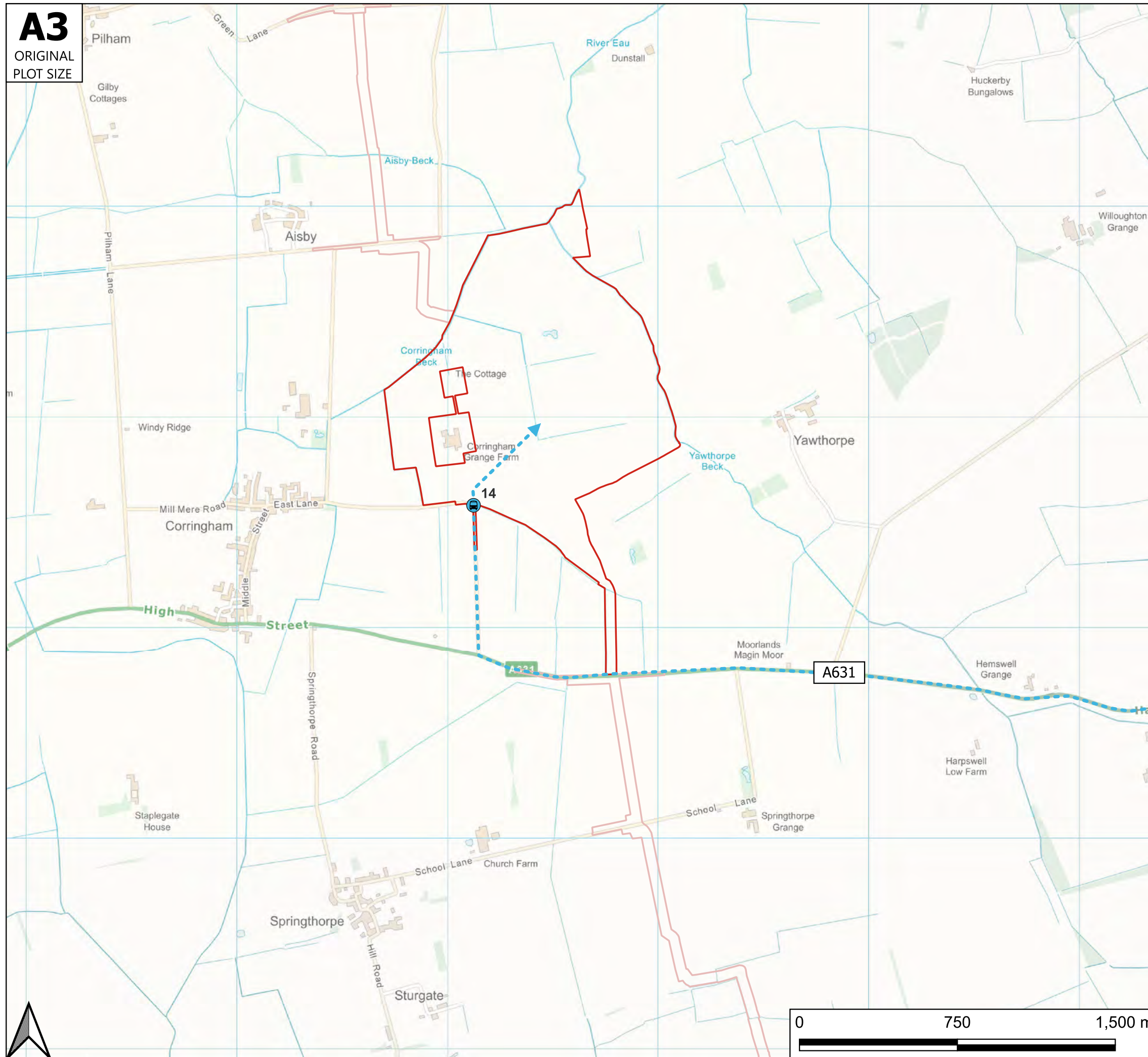

Reproduced from .....

**Key**

- Site Boundary
- - - ▶ Construction Traffic Route
- ⊙ Site Access Locations

Rev	Date	Details	Drawn by	Checked by	Approved by

**Bristol**  
Cambridge  
London  
Oxford  
Welwyn Garden City



Transport Planning Associates

25 King Street  
Bristol  
BS1 4PB

0117 925 9400  
[www.tpa.uk.com](http://www.tpa.uk.com)

CLIENT:  
**Cottam Solar Projects Limited**

PROJECT:  
**Cottam Solar Project**

TITLE:  
**Construction Vehicle Route - Cottam 2**

STATUS:  
**FOR INFORMATION**

SCALE: NTS	DATE: 02/11/23	DRAWN: AC	CHECKED: RR	APPROVED: JD
JOB NO: 2107-062		DRAWING NO: Figure 5.4		REVISION: -

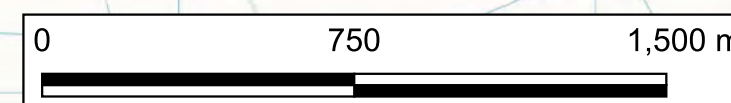

**A3**

ORIGINAL  
PLOT SIZE

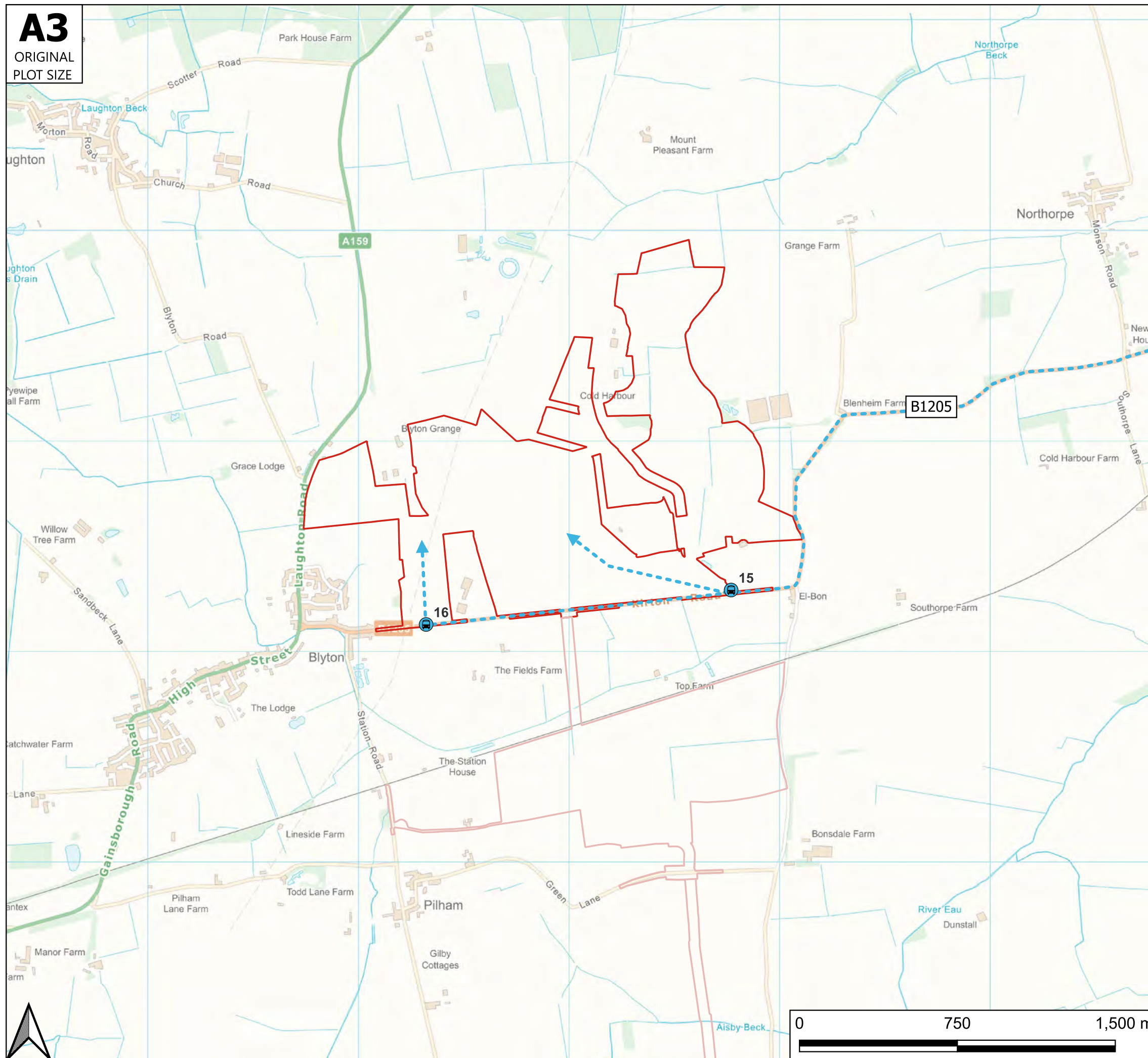

Reproduced from .....

**Key**

- Site Boundary
- Construction Traffic Route
- Site Access Locations

Rev	Date	Details	Drawn by	Checked by	Approved by

Bristol  
Cambridge  
London  
Oxford  
Welwyn Garden City



Transport Planning Associates

25 King Street  
Bristol  
BS1 4PB

0117 925 9400  
[www.tpa.uk.com](http://www.tpa.uk.com)

CLIENT:  
**Cottam Solar Projects Limited**

PROJECT:  
**Cottam Solar Project**

TITLE:  
**Construction Vehicle Route - Cottam 3A**

STATUS:  
**FOR INFORMATION**

SCALE: NTS	DATE: 02/11/23	DRAWN: AC	CHECKED: RR	APPROVED: JD
JOB NO: 2107-062		DRAWING NO: Figure 5.5		REVISION: -

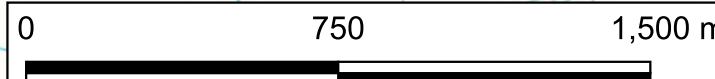

**A3**

ORIGINAL  
PLOT SIZE

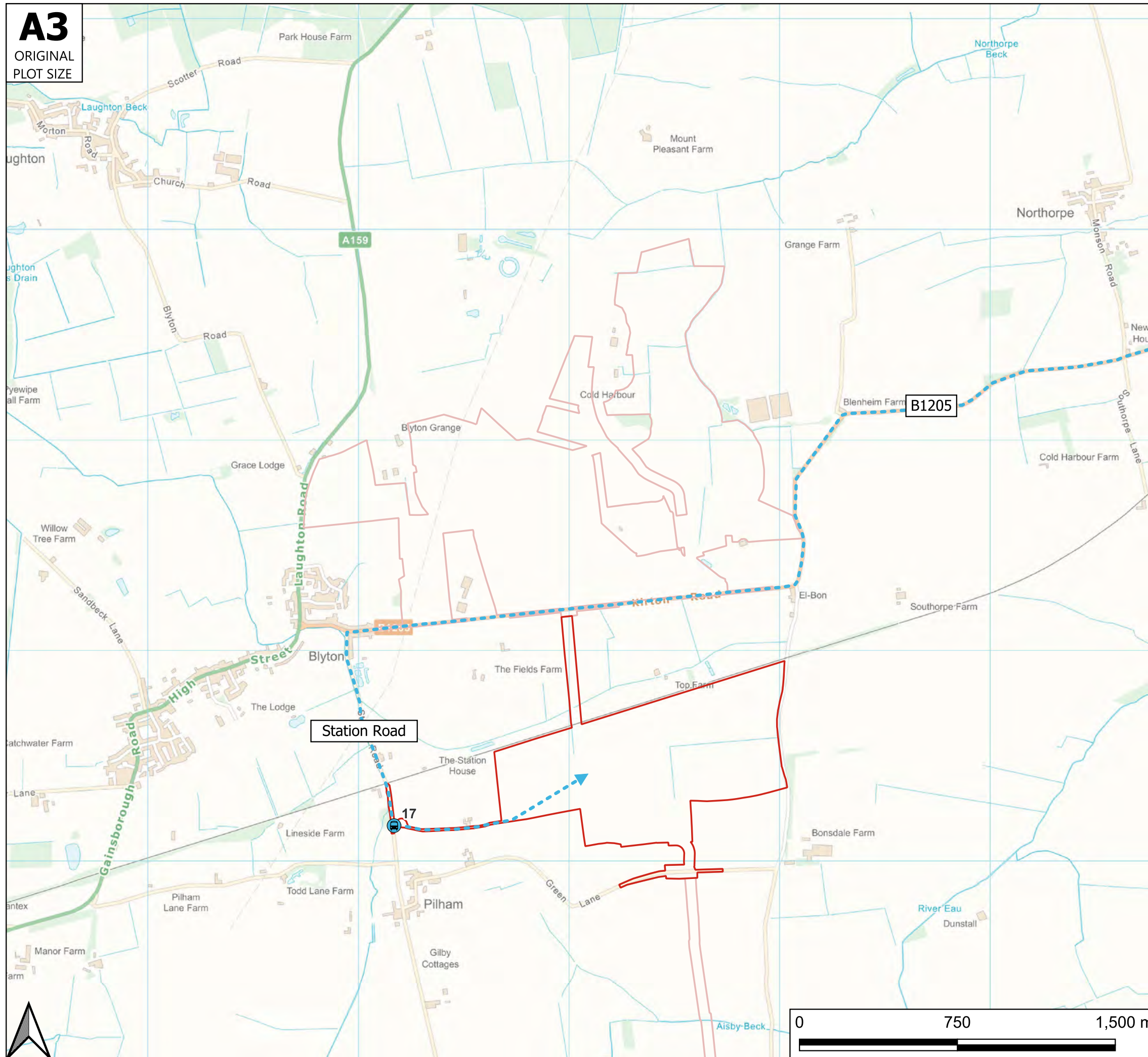

Reproduced from .....

**Key**

- Site Boundary
- > Construction Traffic Route
- ⊙ Site Access Locations

Rev	Date	Details	Drawn by	Checked by	Approved by

**tpa**  
Transport Planning Associates

Bristol  
Cambridge  
London  
Oxford  
Welwyn Garden City

25 King Street  
Bristol  
BS1 4PB

0117 925 9400  
[www.tpa.uk.com](http://www.tpa.uk.com)

CLIENT:  
**Cottam Solar Projects Limited**

PROJECT:  
**Cottam Solar Project**

TITLE:  
**Construction Vehicle Route - Cottam 3B**

STATUS:  
**FOR INFORMATION**

SCALE: NTS	DATE: 02/11/23	DRAWN: AC	CHECKED: RR	APPROVED: JD
JOB NO: 2107-062		DRAWING NO: Figure 5.6		REVISION: -

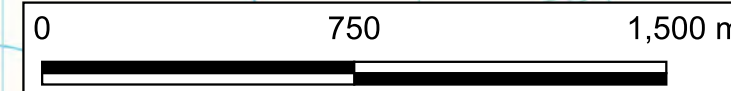

**A3**

ORIGINAL  
PLOT SIZE

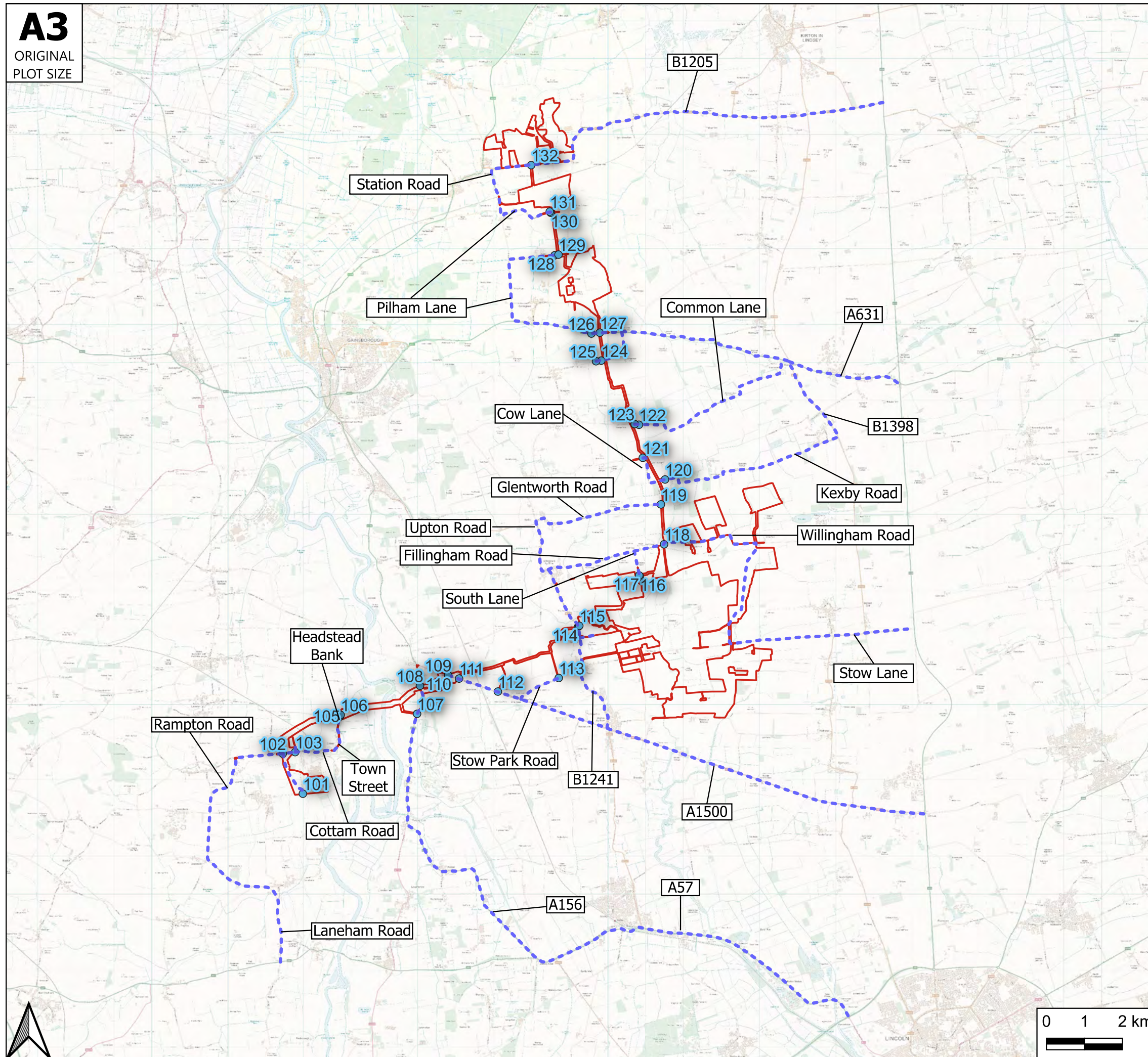

Reproduced from .....

**Key**

- Site Boundary
- Cable Route Access Locations
- Construction Traffic Route

Rev	Date	Details	Drawn by	Checked by	Approved by

Bristol  
Cambridge  
London  
Oxford  
Welwyn Garden City



25 King Street  
Bristol  
BS1 4PB

0117 925 9400  
[www.tpa.uk.com](http://www.tpa.uk.com)

CLIENT:  
**Cottam Solar Projects Limited**

PROJECT:  
**Cottam Solar Project**

TITLE:  
**Construction Vehicle Route -  
Cable Route Corridor**

STATUS:  
**FOR INFORMATION**

SCALE: NTS	DATE: 02/11/23	DRAWN: AC	CHECKED: RR	APPROVED: JD
JOB NO: 2107-062		DRAWING NO: Figure 5.7		REVISION: -



# APPENDIX A

Key  
 Order Limits

Layers: Lanpro, 2022, IGR, 2022  
 Base map: Reproduced from Ordnance Survey digital map data © Crown copyright 2021. All rights reserved. License number 0100031673

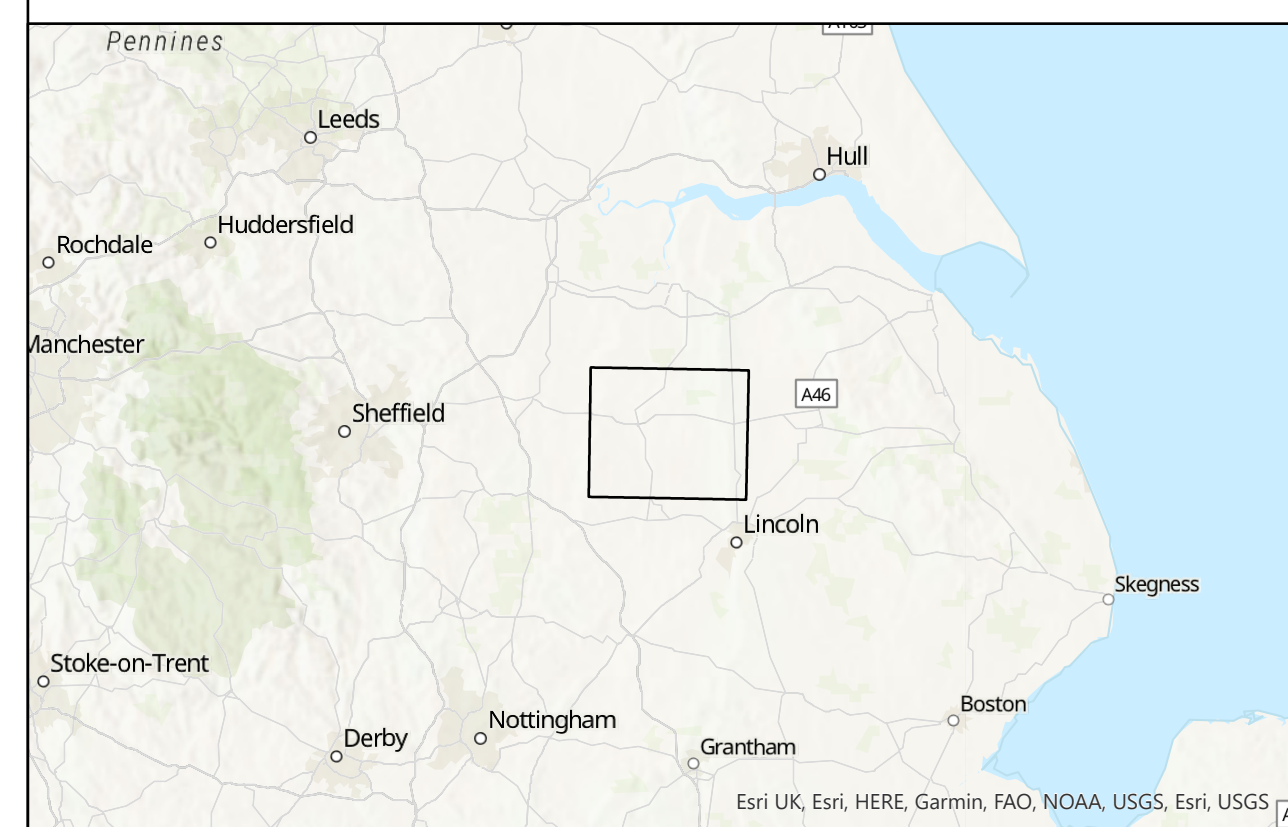

0 1 2 3 Kilometres  
 Scale: 1:25,000@A0

APFP Regulation: 5(2)(o)	Application Doc No. C2.1
Ref: P2981_LPR_ZZ_ON_DR_Z_0088	Date: 13/12/2022
Drawn by: AZ	Checked by: ID

**Location Plan**

**COTTAM SOLAR PROJECT**

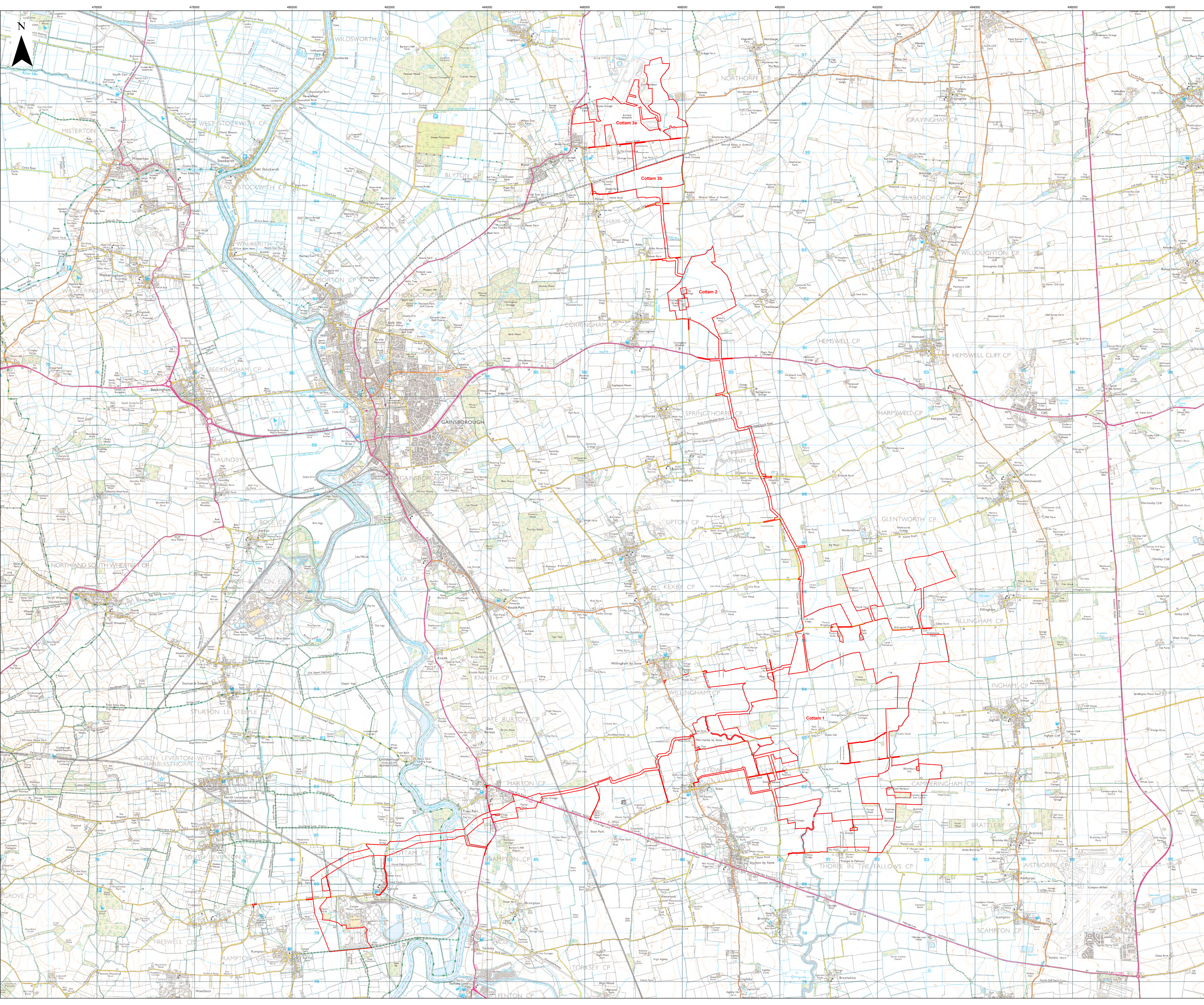

# APPENDIX B

A2  
ORIGINAL  
PLOT SIZE

Reproduced from Ordnance Survey Superplan Data with the permission of The Controller of Her Majesty's Stationery Office. Crown Copyright - Licence No. AL100034021

- NOTES:
1. The existing posted speed limit on Thorpe Lane is National Speed Limit (60mph).
  2. Visibility Splay shown in accordance with DMRB CD 109

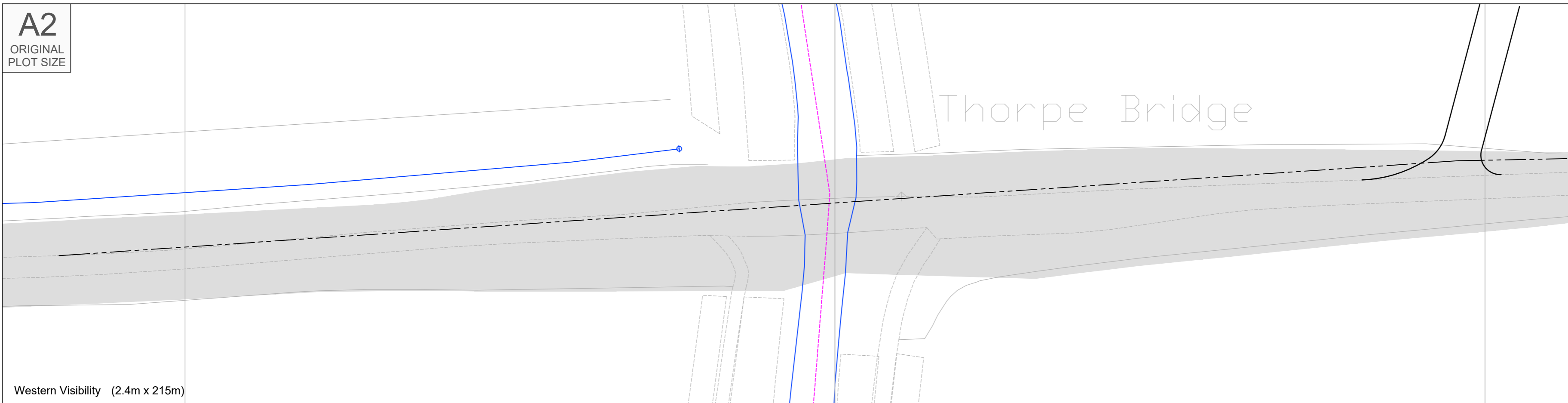

KEY

Approximate extent of adopted highway.

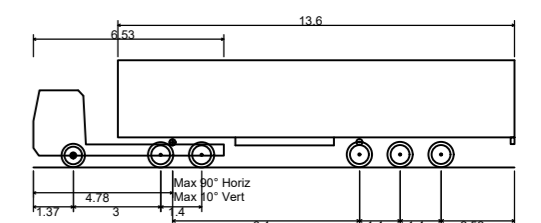

- Max Legal Length (UK) Articulated Vehicle (16.5m)
- Overall Length 16.500m
- Overall Width 2.550m
- Overall Body Height 3.681m
- Min Body Ground Clearance 0.411m
- Max Track Width 2.500m
- Lock to lock time 6.00s
- Kerb to Kerb Turning Radius 6.530m

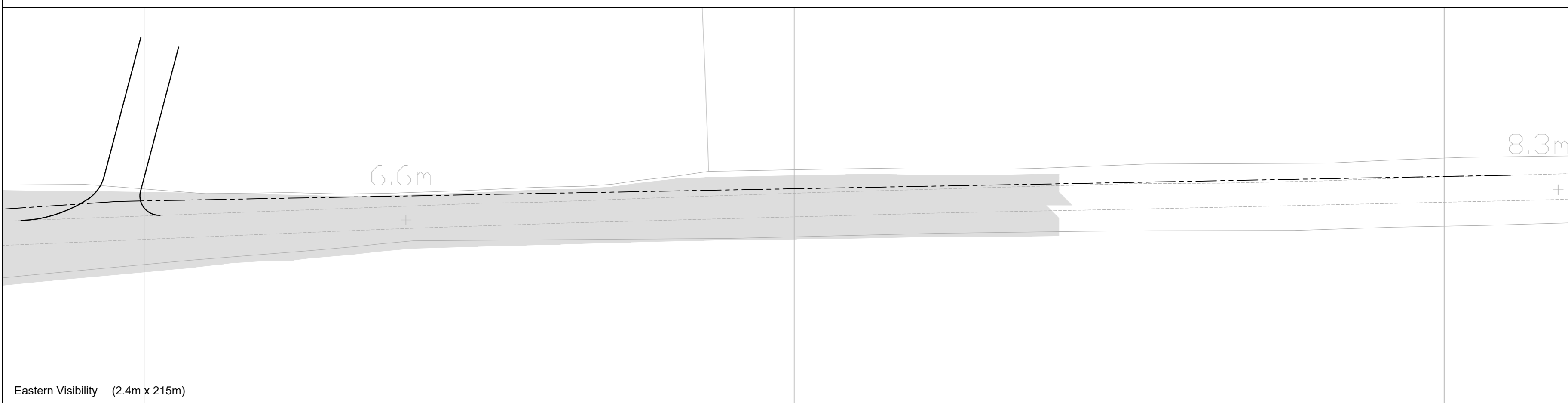

Rev	Date	Details	Drawn by	Checked by	Approved by
-	-	-	-	-	-

Bristol  
Cambridge  
London  
Manchester  
Oxford  
Welwyn Garden City

25 King Street  
Bristol  
BS1 4PB  
0117 925 9400  
[www.tpa.uk.com](http://www.tpa.uk.com)

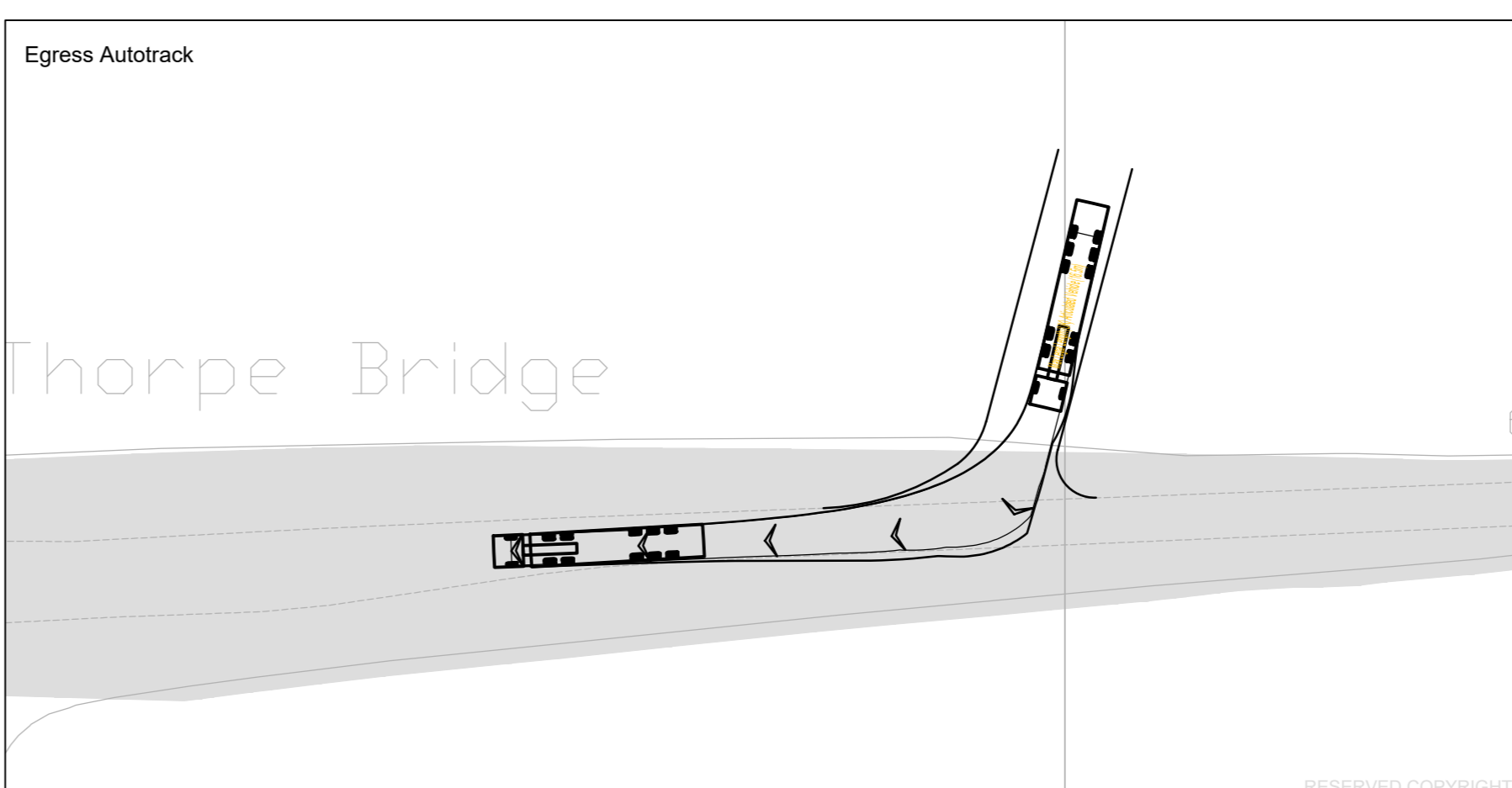
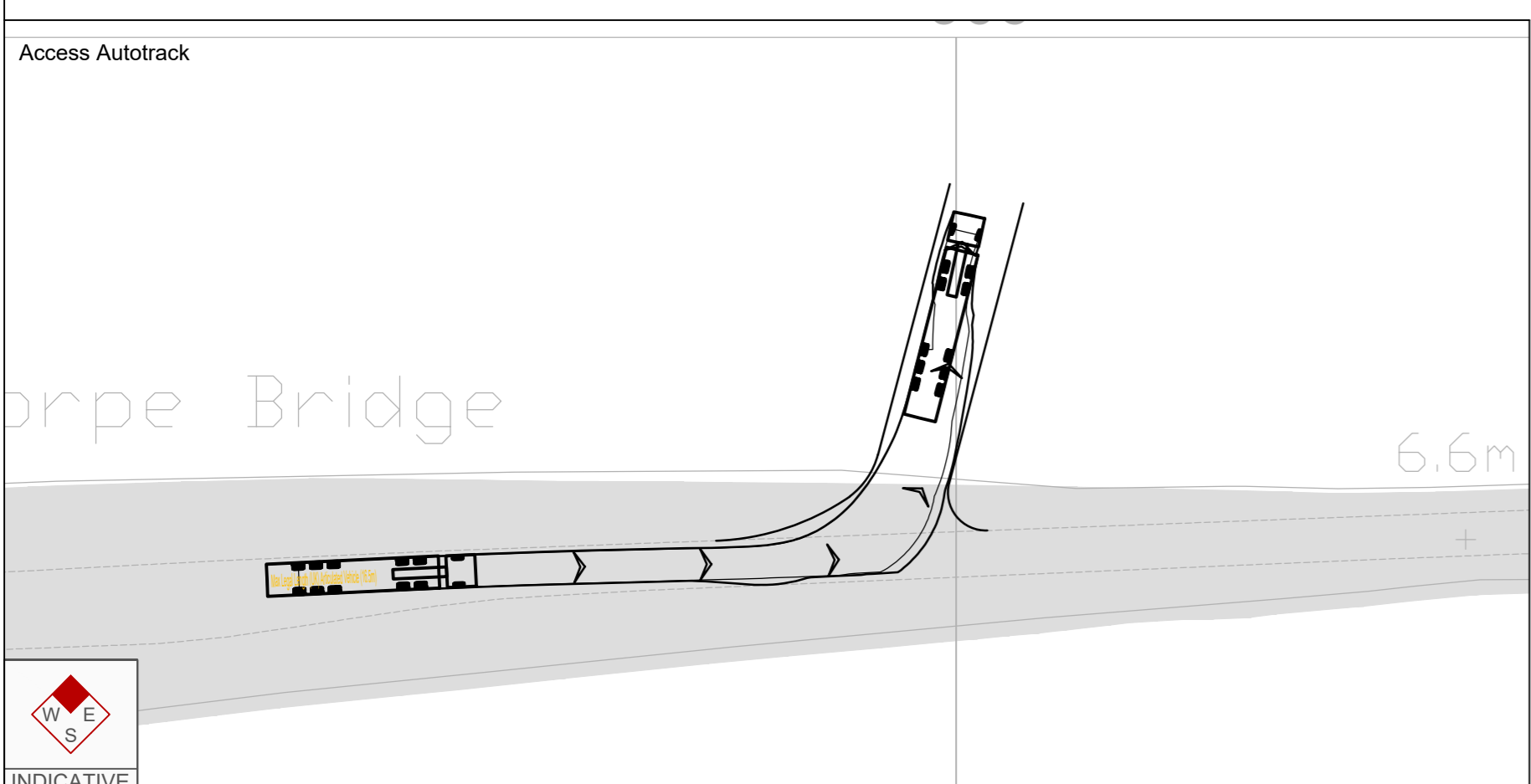

CLIENT:  
**COTTAM SOLAR PROJECT LIMITED**

PROJECT:  
**COTTAM SOLAR FARM**

TITLE:  
**Cottam Solar Farm  
Access 1  
Thorpe Lane**

STATUS:  
**INFORMATION**

SCALE: As Shown	DATE: 08.12.22	DRAWN: AJS	CHECKED: WG	APPROVED: JD
JOB NO: 2107-062	DRAWING NO: SK01	REVISION: -		

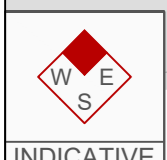

RESERVED COPYRIGHT

**A2**  
ORIGINAL  
PLOT SIZE

Northern Visibility (2.4m x 166m)

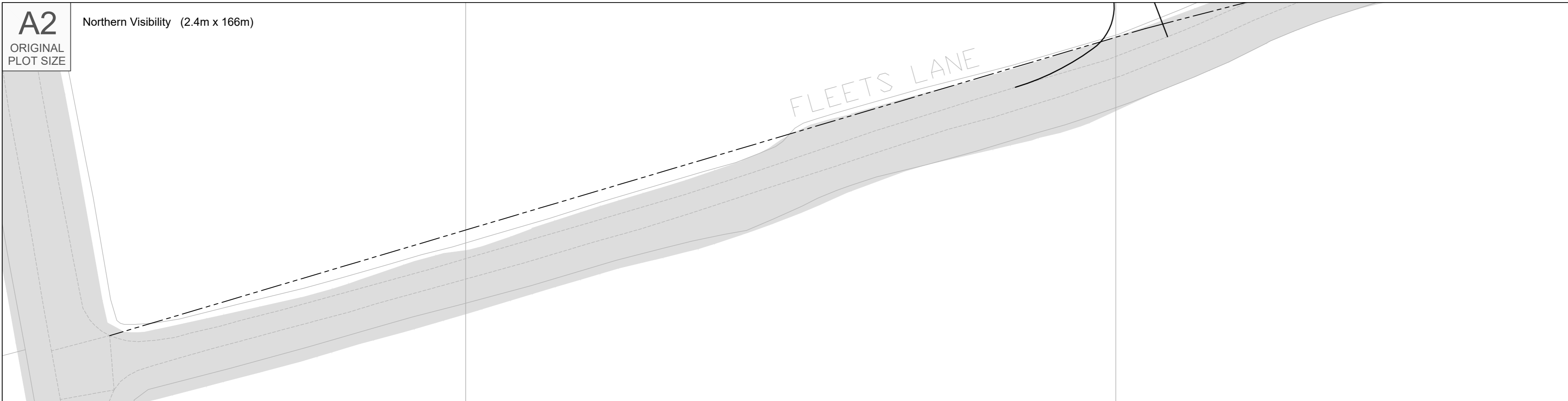

Southern Visibility (2.4m x 215m)

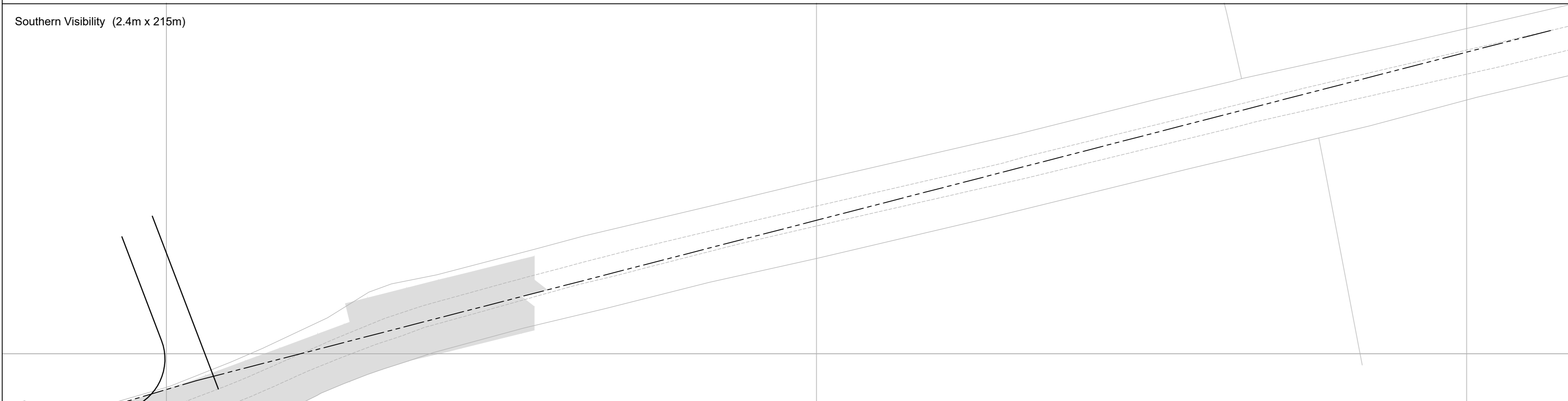

Access Autotrack

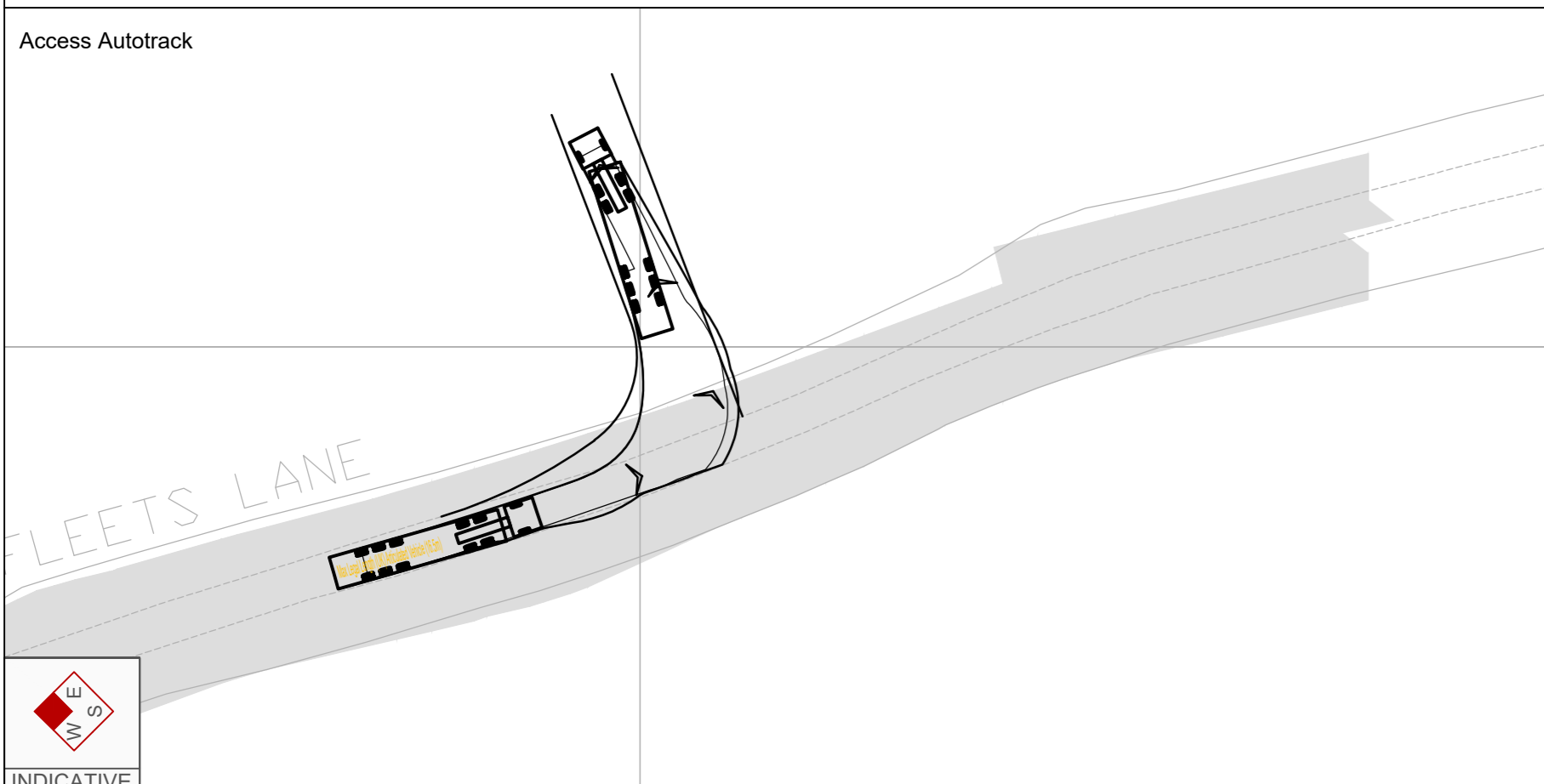

Egress Autotrack

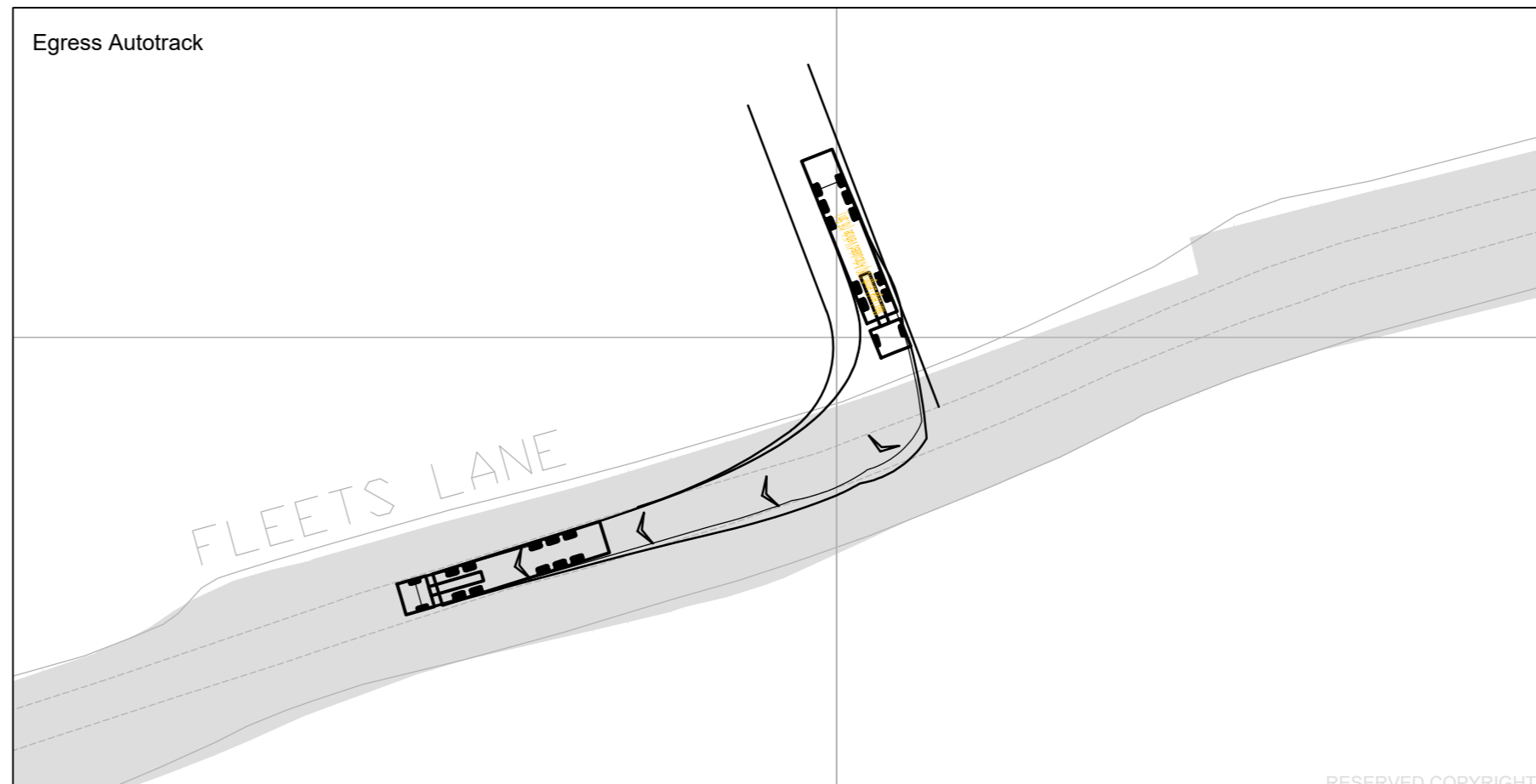

Reproduced from Ordnance Survey Superplan Data with the permission of The Controller of Her Majesty's Stationary Office. Crown Copyright - Licence No. AL100034021

NOTES:

1. The existing posted speed limit on Fleets Lane is National Speed Limit (60mph).
2. Visibility Splay shown in accordance with DMRB CD 109

KEY

 Approximate extent of adopted highway.

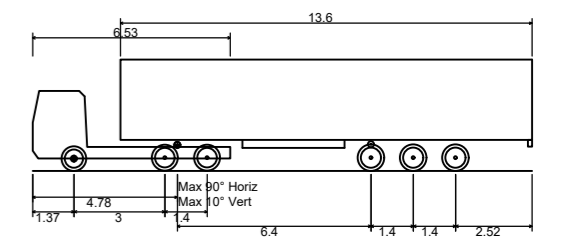

Max Legal Length (UK) Articulated Vehicle (16.5m) 16.500m  
 Overall Length 2.550m  
 Overall Width 3.681m  
 Overall Body Height 0.411m  
 Min Body Ground Clearance 2.500m  
 Max Track Width 6.00s  
 Lock to lock time 6.530m  
 Kerb to Kerb Turning Radius

Rev	Date	Details	Drawn by	Checked by	Approved by
-	-	-	-	-	-

Bristol  
 Cambridge  
 London  
 Manchester  
 Oxford  
 Welwyn Garden City



25 King Street  
 Bristol  
 BS1 4PB  
 0117 925 9400

[www.tpa.uk.com](http://www.tpa.uk.com)

CLIENT:  
**COTTAM SOLAR PROJECT LIMITED**

PROJECT:  
**COTTAM SOLAR FARM**

TITLE:  
**Cottam Solar Farm  
 Access 2  
 Fleets Lane**

STATUS:  
**INFORMATION**

SCALE: 1:500	DATE: 08.12.22	DRAWN: AJS	CHECKED: WG	APPROVED: JD
-----------------	-------------------	---------------	----------------	-----------------

JOB NO: 2107-062	DRAWING NO: SK02	REVISION: -
---------------------	---------------------	----------------

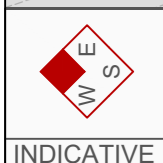

A2  
ORIGINAL  
PLOT SIZE

Reproduced from Ordnance Survey Superplan Data with the permission of The Controller of Her Majesty's Stationary Office. Crown Copyright - Licence No. AL100034021

- NOTES:
1. The existing posted speed limit on Stow Lane is National Speed Limit (60mph).
  2. Visibility Splay shown in accordance with DMRB CD 109

KEY  
 Approximate extent of adopted highway.

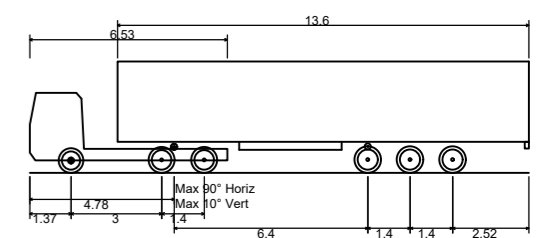

Max Legal Length (UK) Articulated Vehicle (16.5m) 16.500m  
 Overall Length 2.550m  
 Overall Width 3.981m  
 Min Body Ground Clearance 0.411m  
 Max Track Width 2.500m  
 Lock to lock time 6.00s  
 Kerb to Kerb Turning Radius 6.530m

Rev	Date	Details	Drawn by	Checked by	Approved by
-	-	-	-	-	-

Bristol  
 Cambridge  
 London  
 Manchester  
 Oxford  
 Welwyn Garden City

**tpa**  
 Transport Planning Associates

25 King Street  
 Bristol  
 BS1 4PB  
 0117 925 9400  
[www.tpa.uk.com](http://www.tpa.uk.com)

CLIENT:  
**COTTAM SOLAR PROJECT LIMITED**

PROJECT:  
**COTTAM SOLAR FARM**

TITLE:  
**Cottam Solar Farm  
 Access 3  
 Stow Lane**

STATUS:  
**INFORMATION**

SCALE: 1:500	DATE: 08.12.22	DRAWN: AJS	CHECKED: WG	APPROVED: JD
JOB NO: 2107-062	DRAWING NO: SK03	REVISION: -		

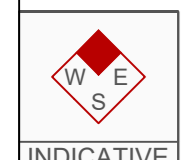
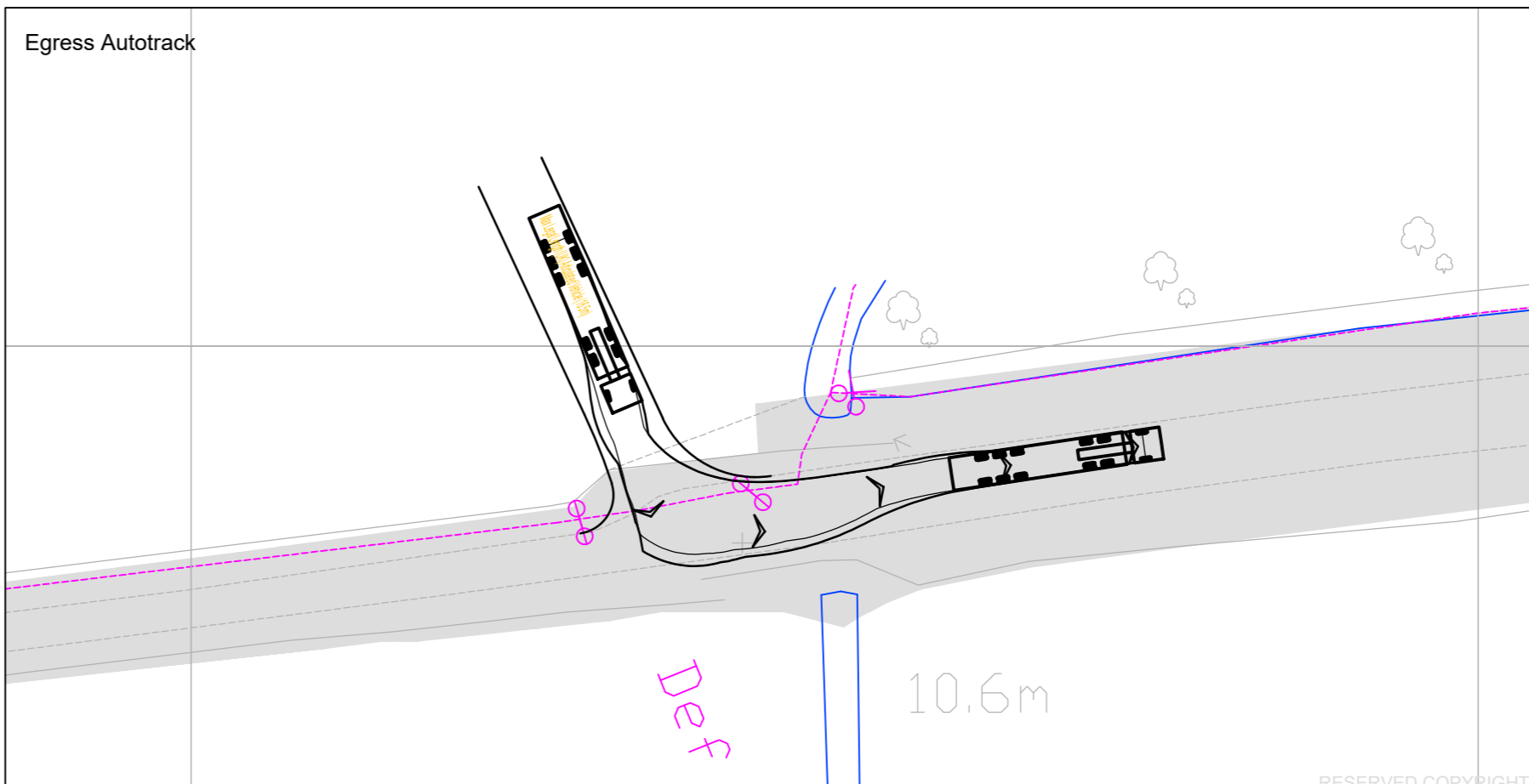
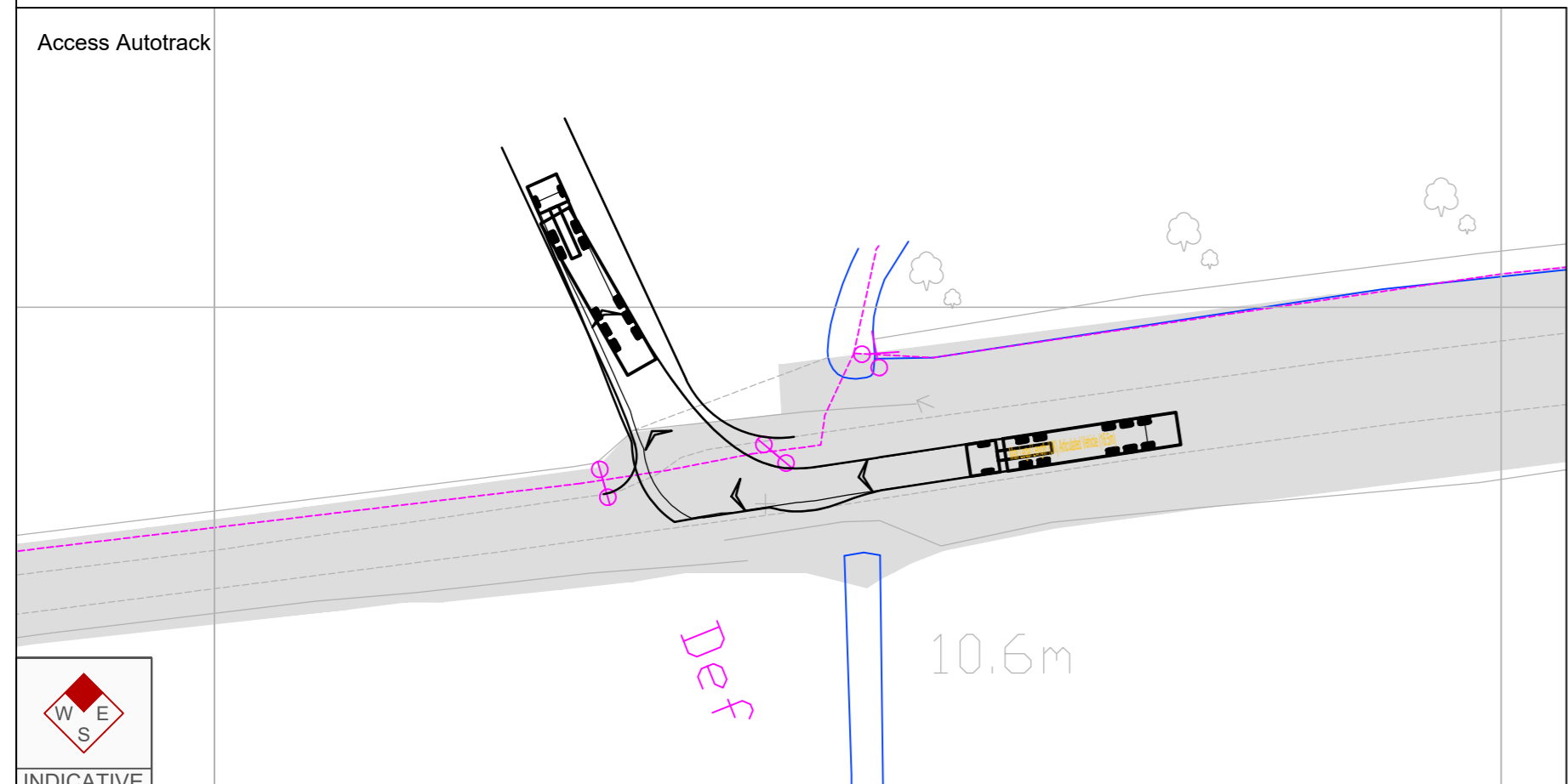
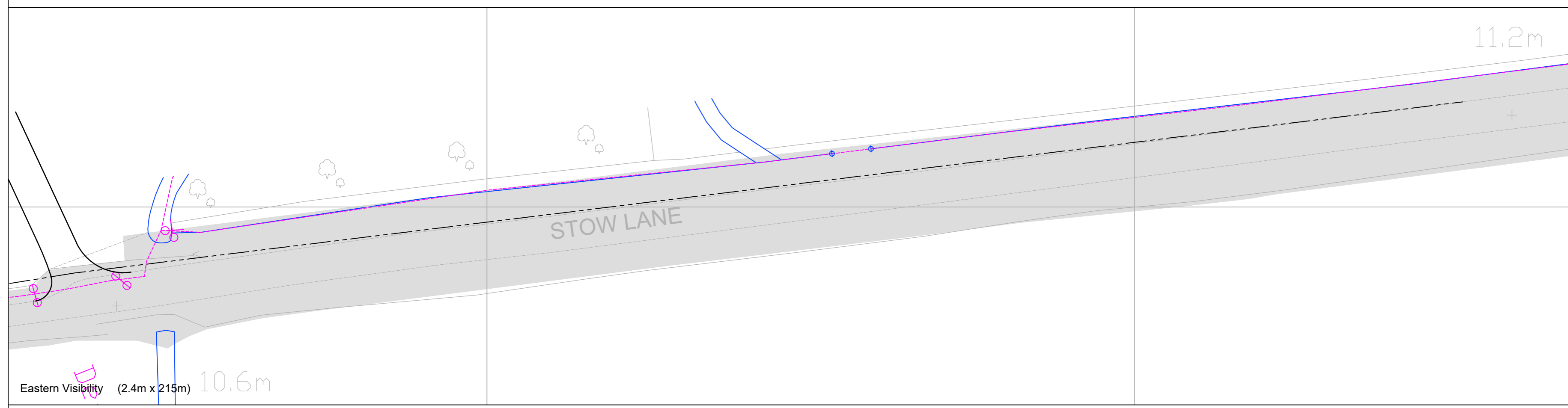
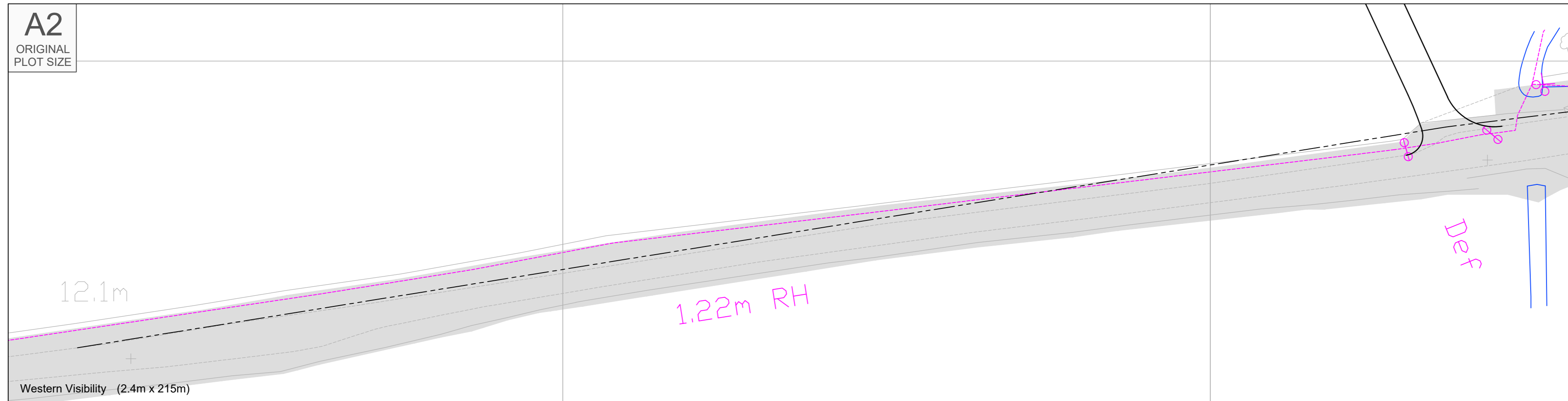

RESERVED COPYRIGHT

**A2**  
ORIGINAL  
PLOT SIZE

Reproduced from Ordnance Survey Superplan Data with the permission of The Controller of Her Majesty's Stationery Office. Crown Copyright - Licence No. AL100034021

- NOTES:
1. The existing posted speed limit on Stow Lane is National Speed Limit (60mph).
  2. Visibility Splay shown in accordance with DMRB CD 109

Drain

Western Visibility (2.4m x 215m)

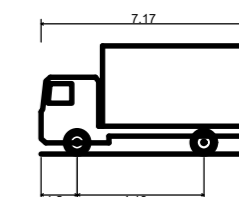

FTA Design 7.5 Tonne Rigid Vehicle (2016)	
Overall Length	7.170m
Overall Width	2.300m
Overall Body Height	3.580m
Min Body Ground Clearance	0.375m
Track Width	2.120m
Lock to lock time	3.00s
Kerb to Kerb Turning Radius	7.000m

1.22m RH

9.0m

Eastern Visibility (2.4m x 215m)

Rev	Date	Details	Drawn by	Checked by	Approved by
-	-	-	-	-	-

Bristol  
Cambridge  
London  
Manchester  
Oxford  
Welwyn Garden City



25 King Street  
Bristol  
BS1 4PB  
0117 925 9400

[www.tpa.uk.com](http://www.tpa.uk.com)

CLIENT:  
**COTTAM SOLAR PROJECT LIMITED**

PROJECT:  
**COTTAM SOLAR FARM**

TITLE:  
**Cottam Solar Farm  
Access 4 - Operational  
Stow Lane**

STATUS:  
**INFORMATION**

SCALE: 1:500	DATE: 08.12.22	DRAWN: SG	CHECKED: RR	APPROVED: JD
-----------------	-------------------	--------------	----------------	-----------------

JOB NO: 2107-062	DRAWING NO: SK04	REVISION: -
---------------------	---------------------	----------------

Access Autotrack

Egress Autotrack

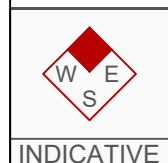

RESERVED COPYRIGHT

**A2**  
ORIGINAL  
PLOT SIZE

Reproduced from Ordnance Survey Superplan Data with the permission of The Controller of Her Majesty's Stationery Office. Crown Copyright - Licence No. AL100034021

2.4m x 215m visibility splay  
(North Area 2 access).

19.3m

2.4m x 215m visibility splay  
(North Area 1 access).

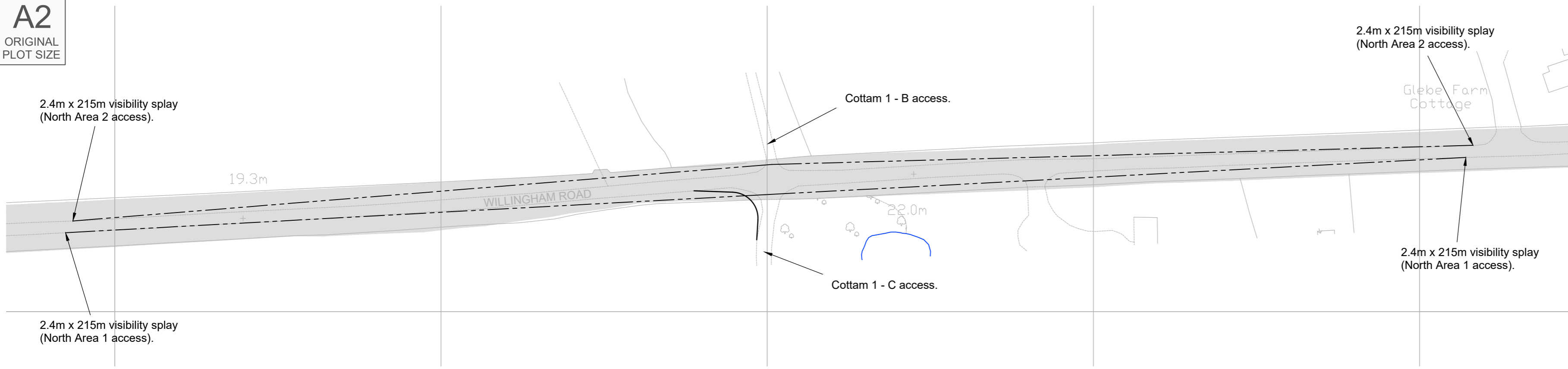

**Site Access Arrangement**

Scale 1:1000

**NOTES:**

1. The existing posted speed limit on Willingham Road is National Speed Limit (60mph).

**KEY**

Approximate extent of adopted highway.

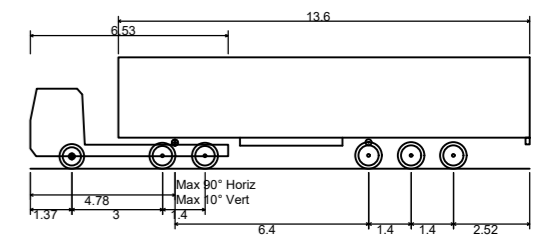

Max Legal Length (UK) Articulated Vehicle (16.5m) 16.500m  
 Overall Length 2.550m  
 Overall Width 3.681m  
 Overall Body Height 0.411m  
 Min Body Ground Clearance 2.500m  
 Max Track Width 6.00s  
 Lock to lock time 6.530m  
 Kerb to Kerb Turning Radius

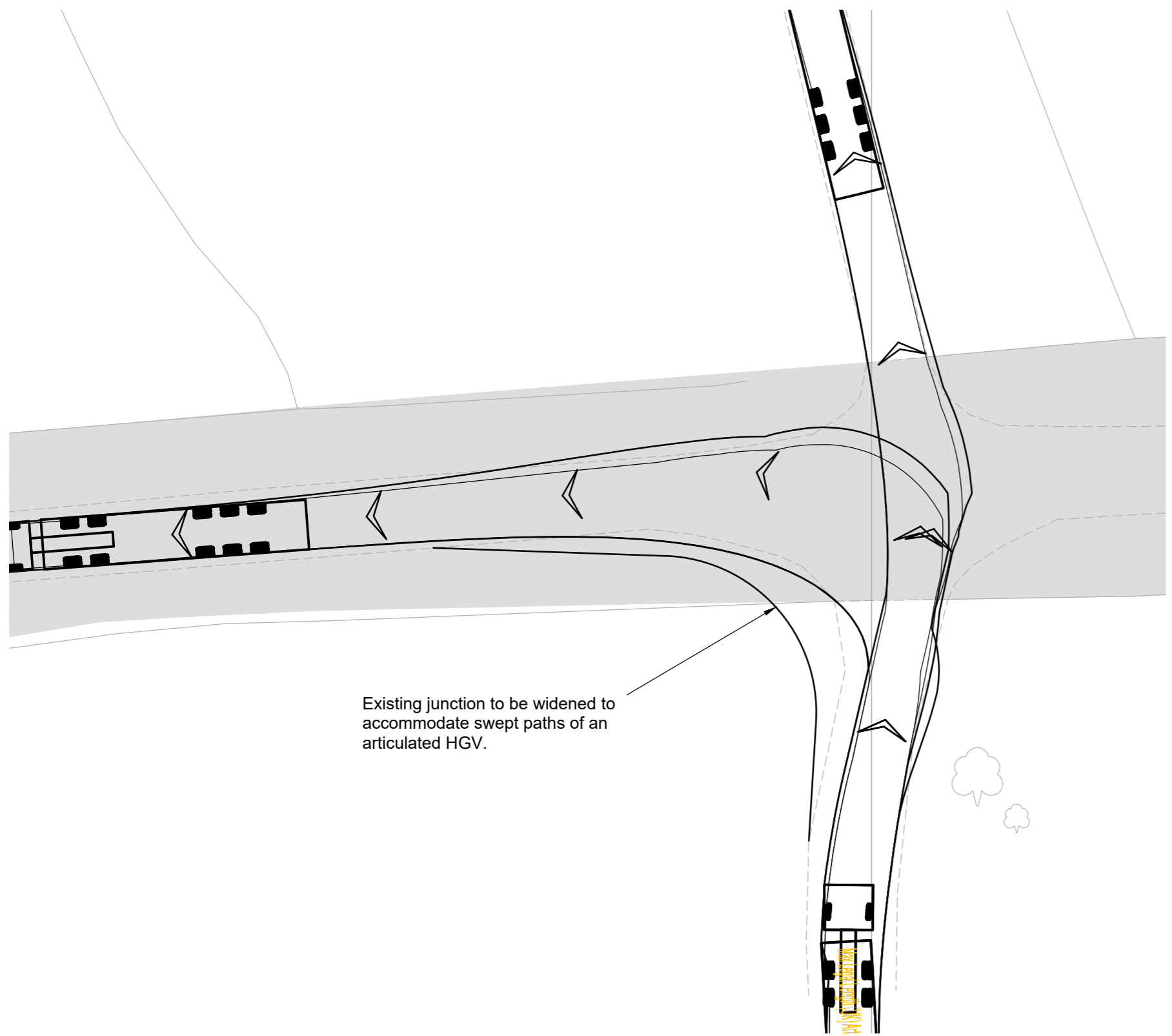

Existing junction to be widened to accommodate swept paths of an articulated HGV.

**Swept Paths Of 16.5m Articulated Vehicle Arriving**

Scale 1:250

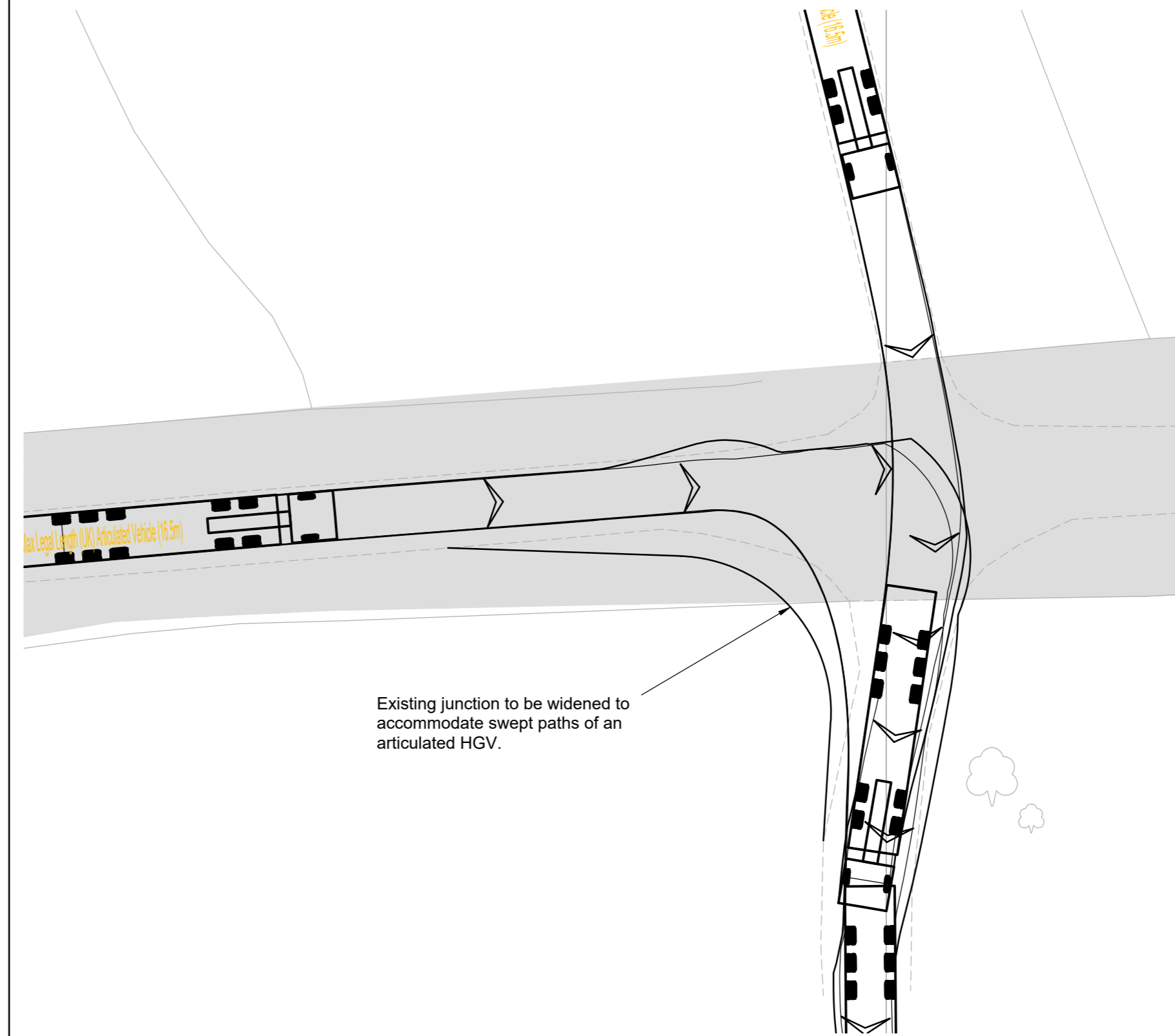

Existing junction to be widened to accommodate swept paths of an articulated HGV.

**Swept Paths Of 16.5m Articulated Vehicle Departing**

Scale 1:250

Rev	Date	Details	Drawn by	Checked by	Approved by
-	-	-	-	-	-

**Bristol**  
 Cambridge  
 London  
 Manchester  
 Oxford  
 Welwyn Garden City

25 King Street  
 Bristol  
 BS1 4PB  
 0117 925 9400  
[www.tpa.uk.com](http://www.tpa.uk.com)

CLIENT:  
**COTTAM SOLAR PROJECT LIMITED**

PROJECT:  
**COTTAM SOLAR FARM**

TITLE:  
**Cottam Solar Farm  
 Access 5  
 Willingham Road**

STATUS:  
**INFORMATION**

SCALE: As Shown	DATE: 08.12.22	DRAWN: PSW	CHECKED: WG	APPROVED: JD
JOB NO: 2107-062	DRAWING NO: SK05		REVISION: -	

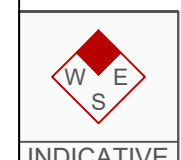

INDICATIVE

RESERVED COPYRIGHT



A2  
ORIGINAL  
PLOT SIZE

Reproduced from Ordnance Survey Superplan Data with the permission of The Controller of Her Majesty's Stationery Office. Crown Copyright - Licence No. AL100034021

NOTES:  
1. The existing posted speed limit on Willingham Road is National Speed Limit (60mph).

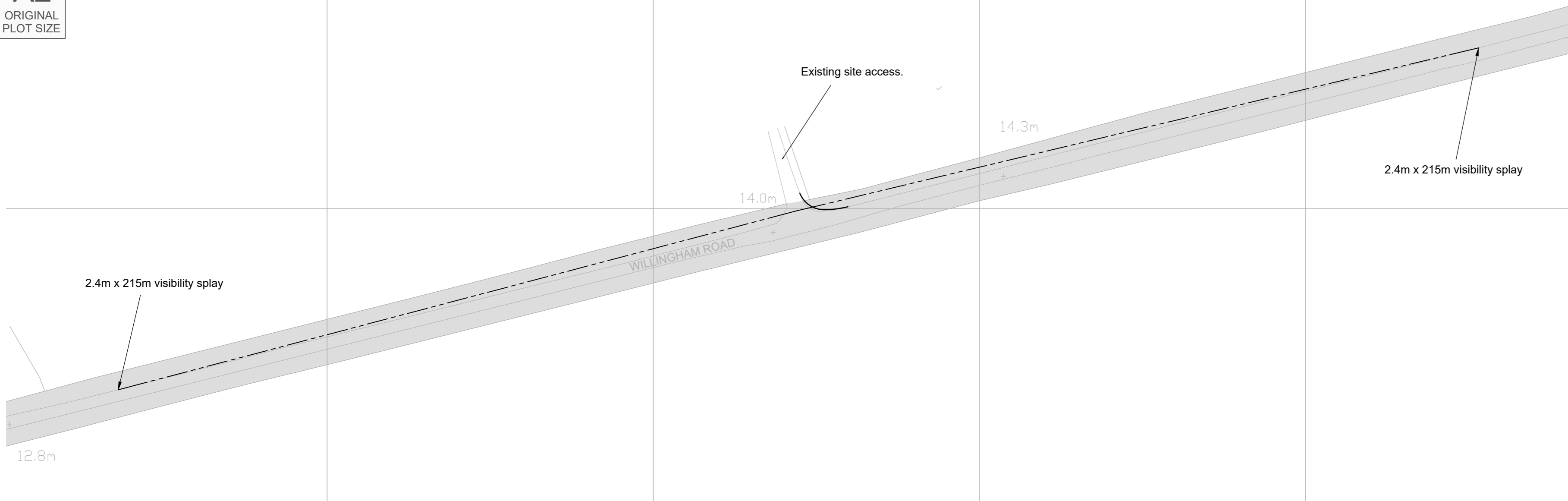

KEY  
Approximate extent of adopted highway.

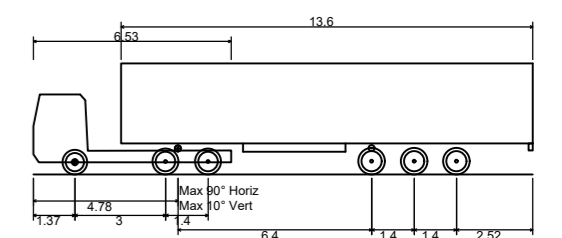

Max Legal Length (UK) Articulated Vehicle (16.5m) 16.500m  
 Overall Length 2.550m  
 Overall Width 3.681m  
 Overall Body Height 0.411m  
 Min Body Ground Clearance 2.500m  
 Max Track Width 6.00s  
 Lock to lock time 6.530m

Site Access Arrangement  
Scale 1:1000

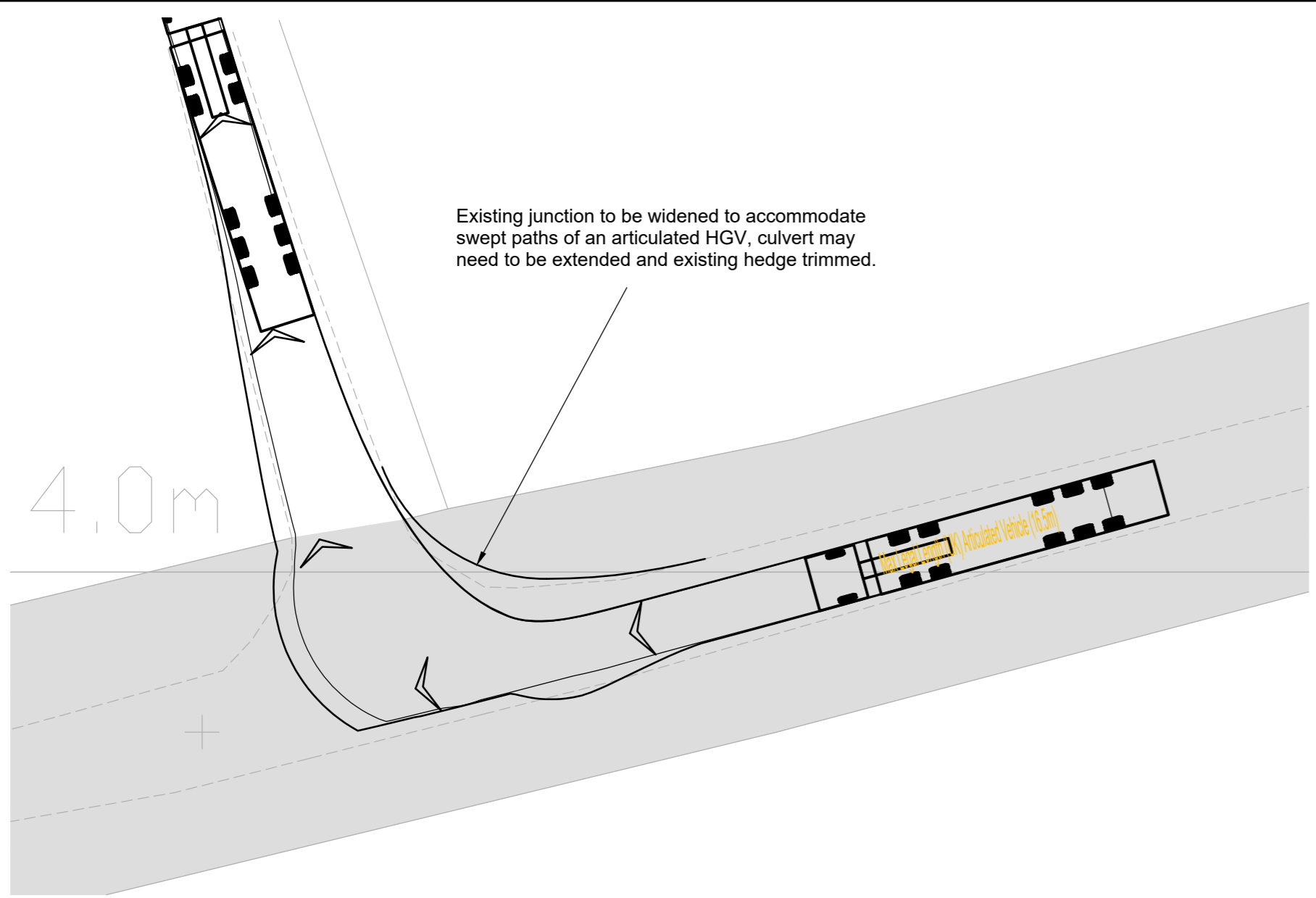

16.5m Articulated Vehicle Turning Right Into Access  
Scale 1:250

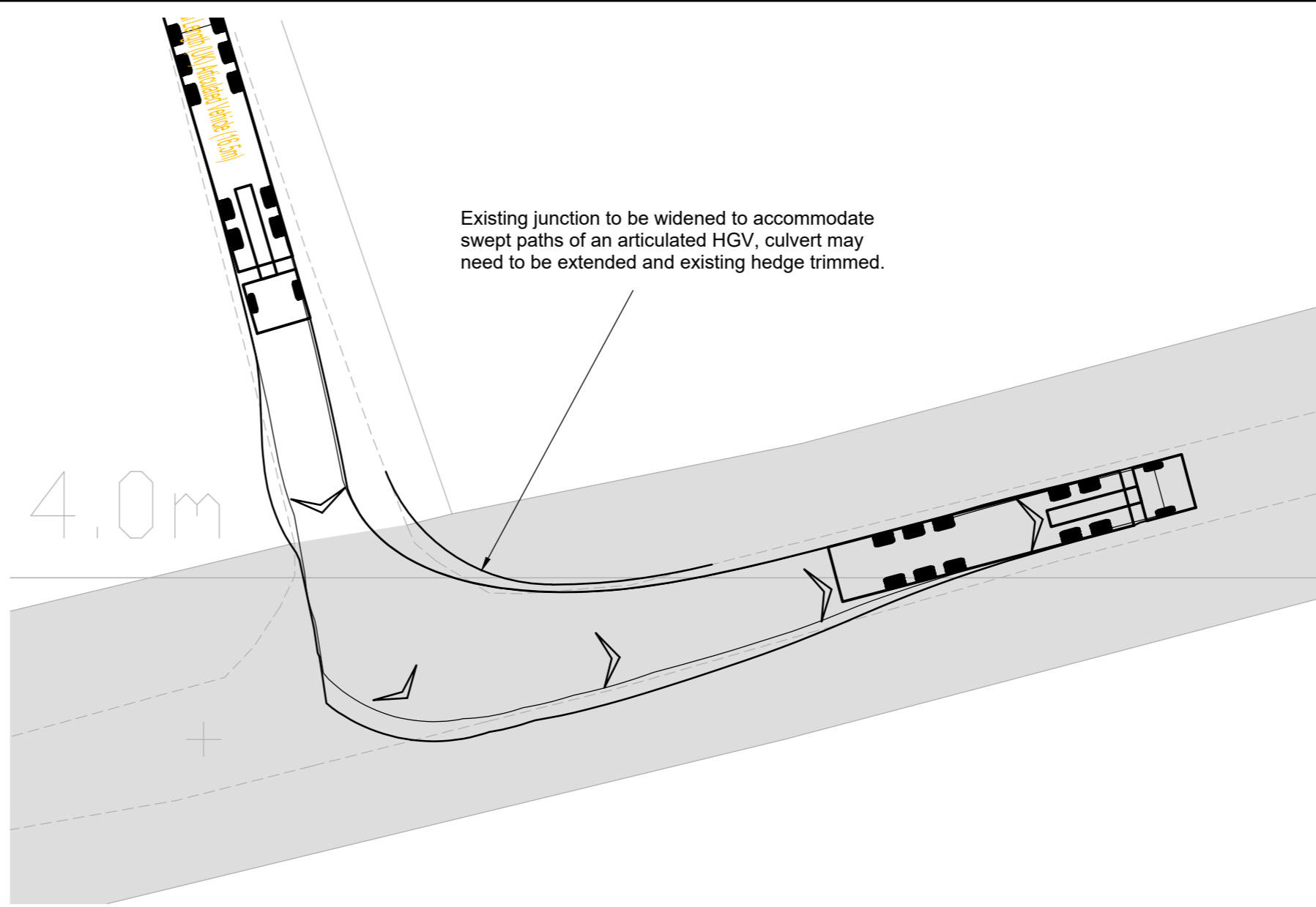

16.5m Articulated Vehicle Turning Left Out Of Access  
Scale 1:250

Rev	Date	Details	Drawn by	Checked by	Approved by
-	-	-	-	-	-

Bristol  
 Cambridge  
 London  
 Manchester  
 Oxford  
 Welwyn Garden City

**tpa**  
 Transport Planning Associates

25 King Street  
 Bristol  
 BS1 4PB  
 0117 925 9400  
[www.tpa.uk.com](http://www.tpa.uk.com)

CLIENT:  
COTTAM SOLAR PROJECT LIMITED

PROJECT:  
COTTAM SOLAR FARM

TITLE:  
Cottam Solar Farm  
 Access 6  
 Willingham Road

STATUS:  
**INFORMATION**

SCALE: As Shown	DATE: 08.12.22	DRAWN: PSW	CHECKED: WG	APPROVED: JD
JOB NO: 2107-062	DRAWING NO: SK06	REVISION: -		

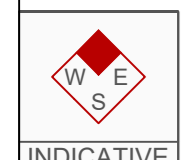

RESERVED COPYRIGHT

A2  
ORIGINAL  
PLOT SIZE

Reproduced from Ordnance Survey Superplan Data with the permission of The Controller of Her Majesty's Stationery Office. Crown Copyright - Licence No. AL100034021

NOTES:  
1. The existing posted speed limit on Willingham Road is National Speed Limit (60mph).

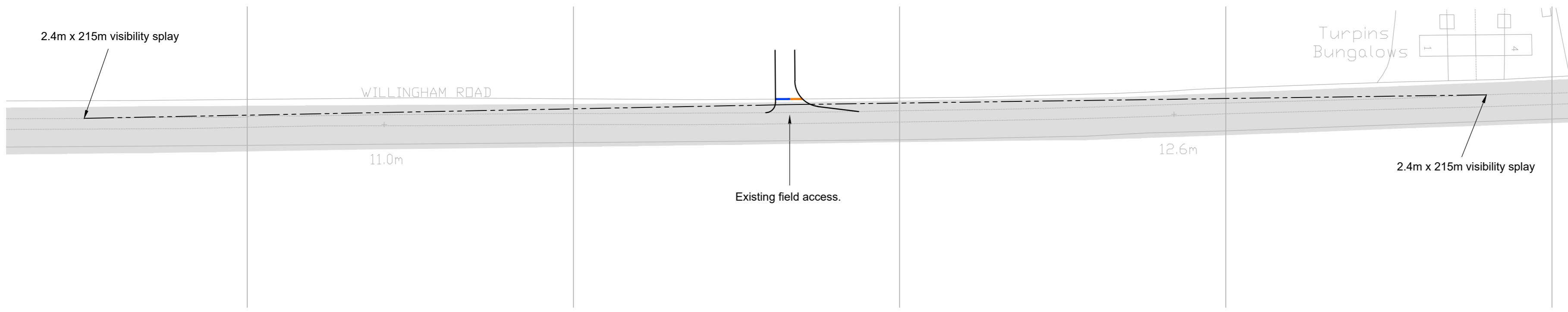

KEY  
 Existing field access.  
 Proposed access widening.  
 Approximate extent of adopted highway.

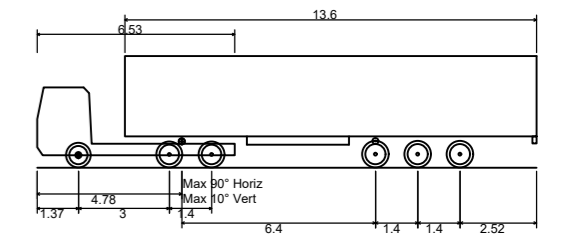

Max Legal Length (UK) Articulated Vehicle (16.5m)  
 Overall Length 16.500m  
 Overall Width 2.550m  
 Overall Body Height 3.681m  
 Min Body Ground Clearance 0.411m  
 Max Track Width 2.500m  
 Lock to lock time 6.00s  
 Kerb to Kerb Turning Radius 6.530m

**Site Access Arrangement**  
Scale 1:1000

Rev	Date	Details	Drawn by	Checked by	Approved by
-	-	-	-	-	-

**Bristol**  
 Cambridge  
 London  
 Manchester  
 Oxford  
 Welwyn Garden City

25 King Street  
 Bristol  
 BS1 4PB  
 0117 925 9400  
[www.tpa.uk.com](http://www.tpa.uk.com)

CLIENT:  
**COTTAM SOLAR PROJECT LIMITED**

PROJECT:  
**COTTAM SOLAR FARM**

TITLE:  
**Cottam Solar Farm  
Access 7  
Willingham Road**

STATUS:  
**INFORMATION**

SCALE: As Shown	DATE: 08.12.22	DRAWN: PSW	CHECKED: WG	APPROVED: JD
JOB NO: 2107-062	DRAWING NO: SK07		REVISION: -	

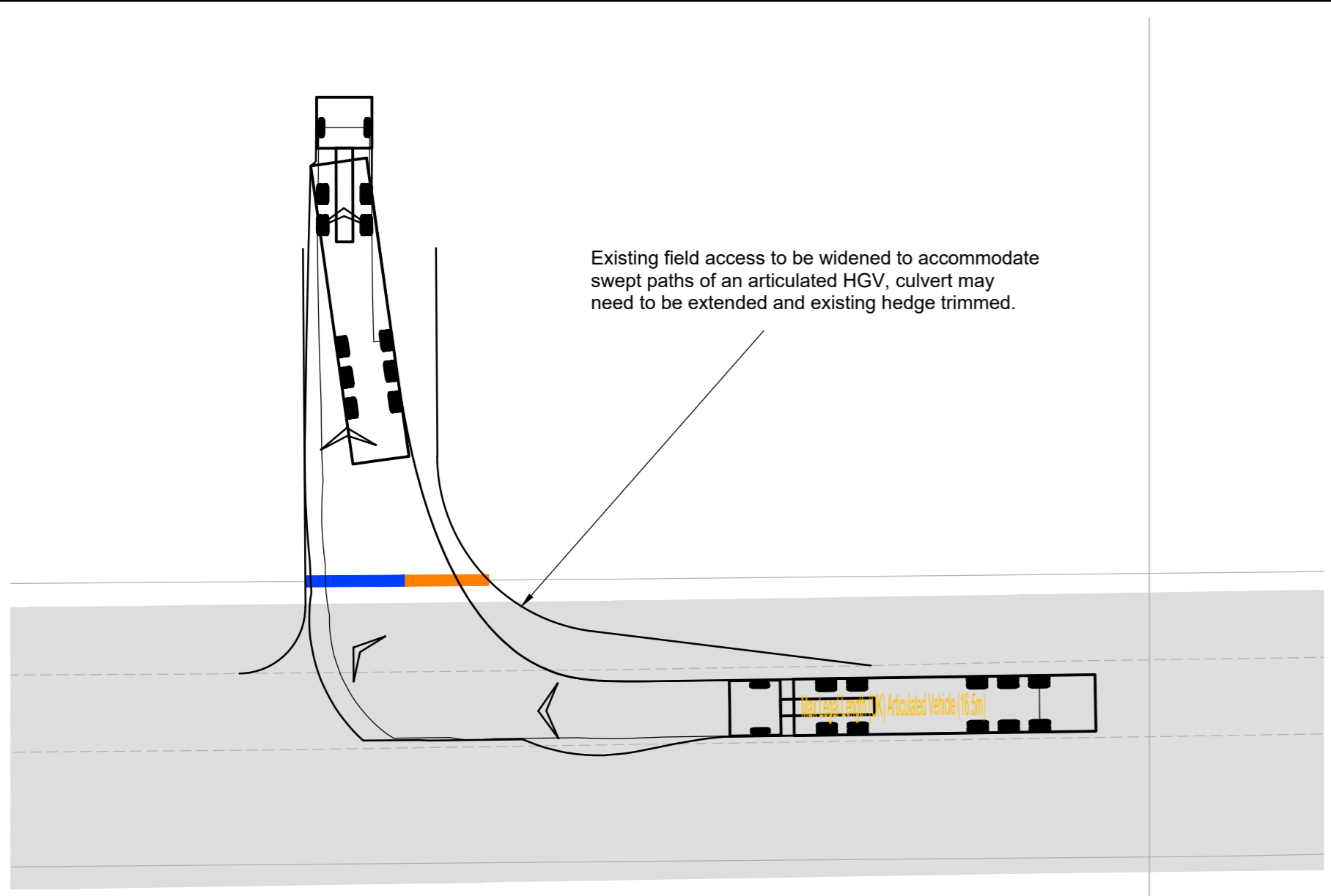

**16.5m Articulated Vehicle Turning Right Into Access**  
Scale 1:250

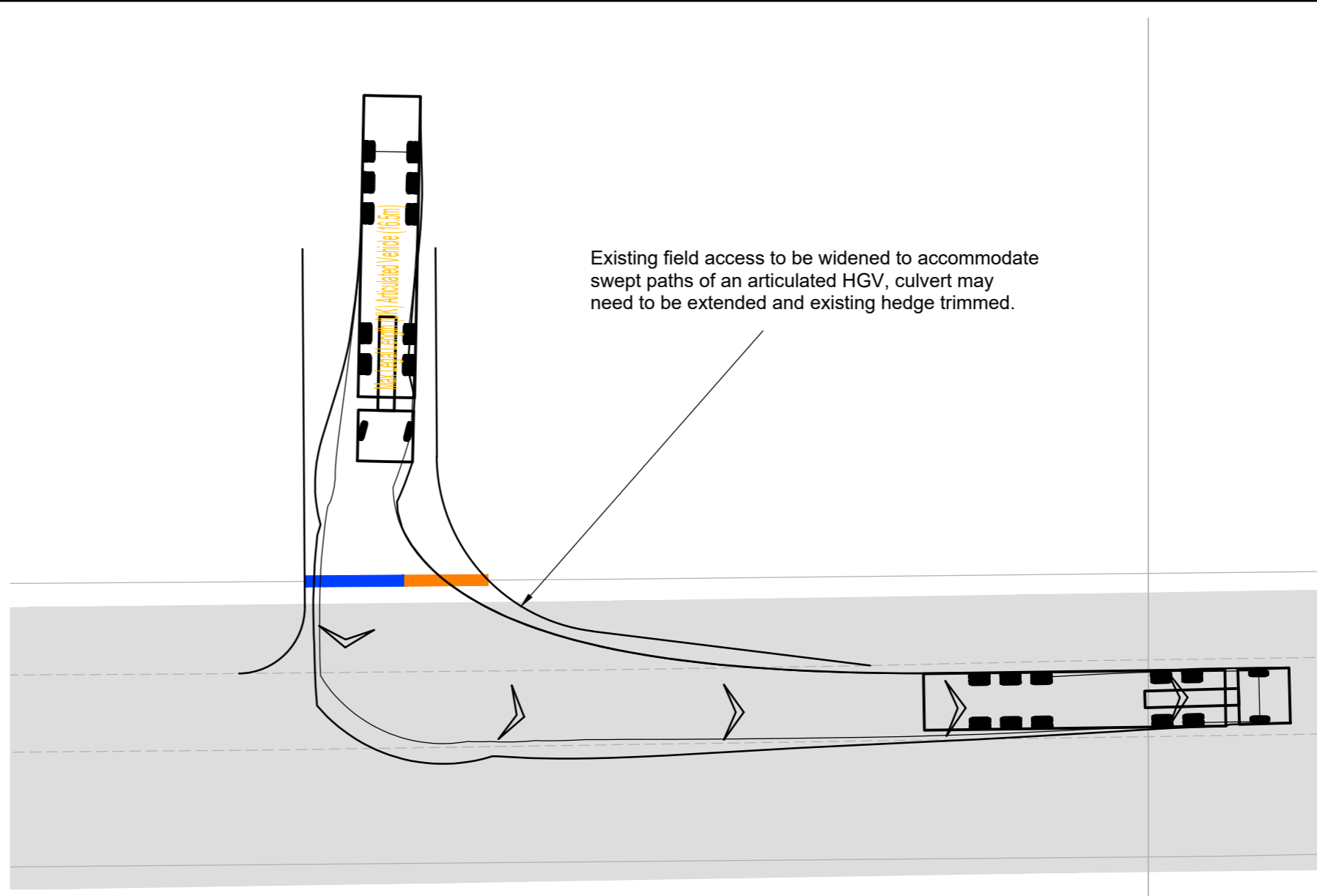

**16.5m Articulated Vehicle Turning Left Out Of Access**  
Scale 1:250

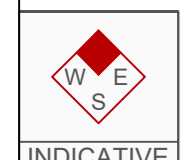

INDICATIVE

RESERVED COPYRIGHT

**A2**  
ORIGINAL  
PLOT SIZE

Reproduced from Ordnance Survey Superplan Data with the permission of The Controller of Her Majesty's Stationery Office. Crown Copyright - Licence No. AL100034021

- NOTES:
1. The existing posted speed limit on Ingham Road is National Speed Limit (60mph).
  2. Visibility splays shown in accordance with DMRB CD 109.

KEY  
 Approximate extent of adopted highway.

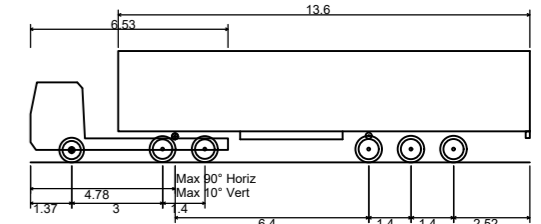

Max Legal Length (UK) Articulated Vehicle (16.5m)  
 Overall Length 16.500m  
 Overall Width 2.550m  
 Overall Body Height 3.681m  
 Min Body Ground Clearance 0.411m  
 Max Track Width 2.500m  
 Lock to lock time 6.00s  
 Kerb to Kerb Turning Radius 6.530m

Rev	Date	Details	Drawn by	Checked by	Approved by
-	-	-	-	-	-

**Bristol**  
 Cambridge  
 London  
 Manchester  
 Oxford  
 Welwyn Garden City



25 King Street  
 Bristol  
 BS1 4PB  
 0117 925 9400  
[www.tpa.uk.com](http://www.tpa.uk.com)

CLIENT:  
**COTTAM SOLAR PROJECT LIMITED**

PROJECT:  
**COTTAM SOLAR FARM**

TITLE:  
**Cottam Solar Farm  
 Access 8  
 Ingham Road**

STATUS:  
**INFORMATION**

SCALE: 1:500	DATE: 01.10.21	DRAWN: AJS	CHECKED: WG	APPROVED: JD
JOB NO: 2107-062	DRAWING NO: SK08	REVISION: -		

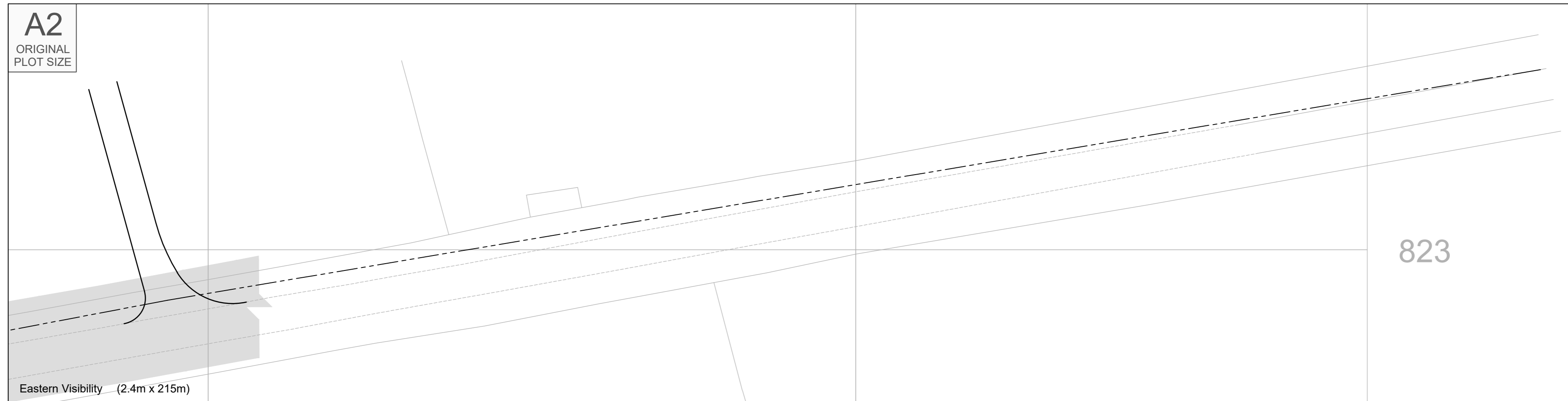

Eastern Visibility (2.4m x 215m)

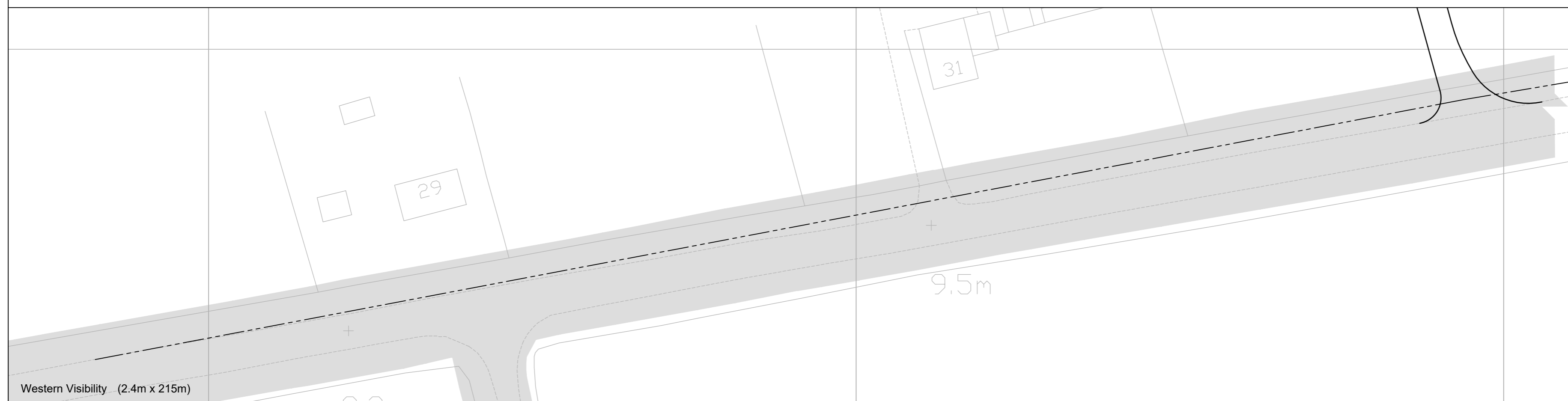

Western Visibility (2.4m x 215m)

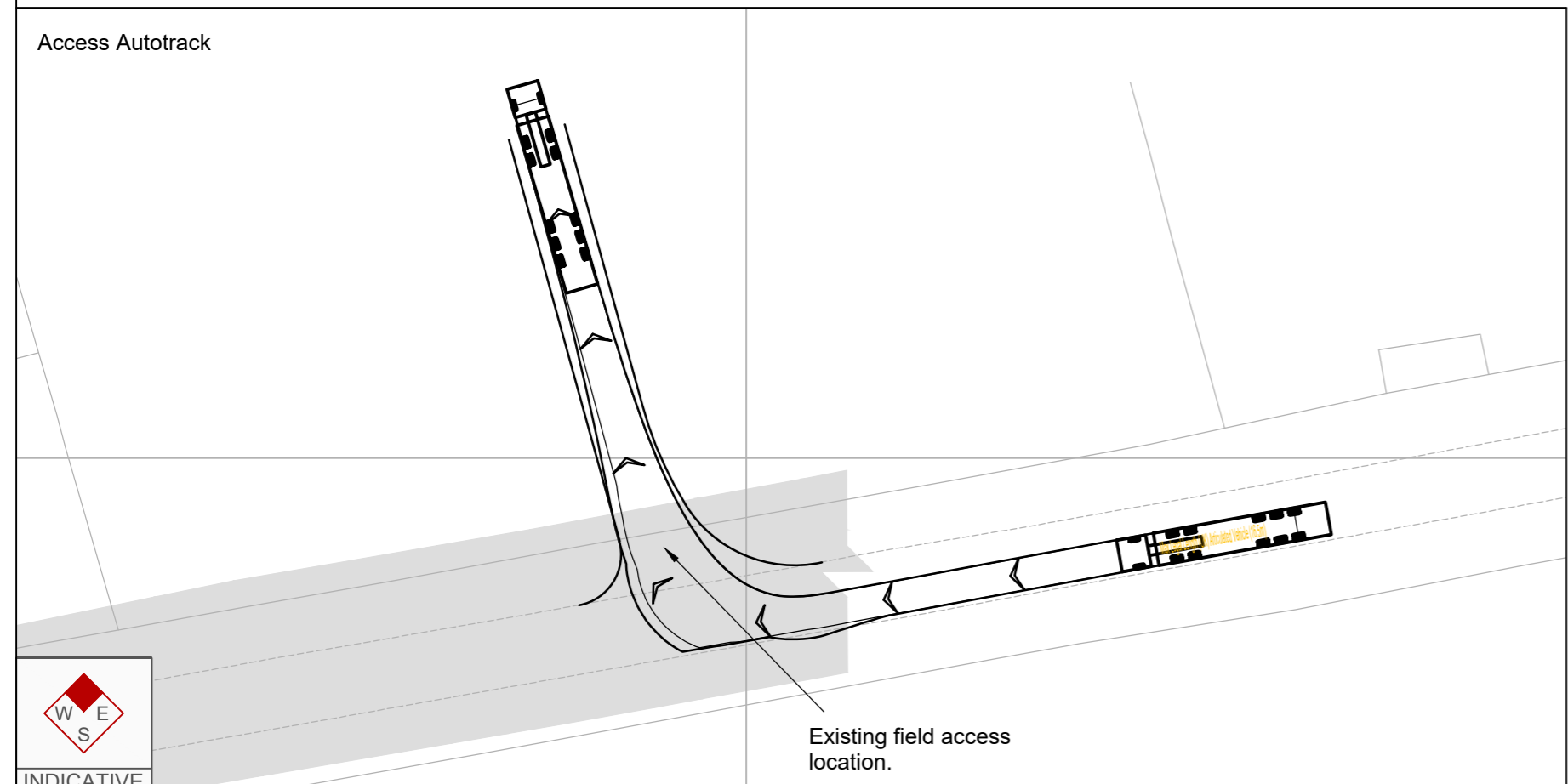

Access Autotrack

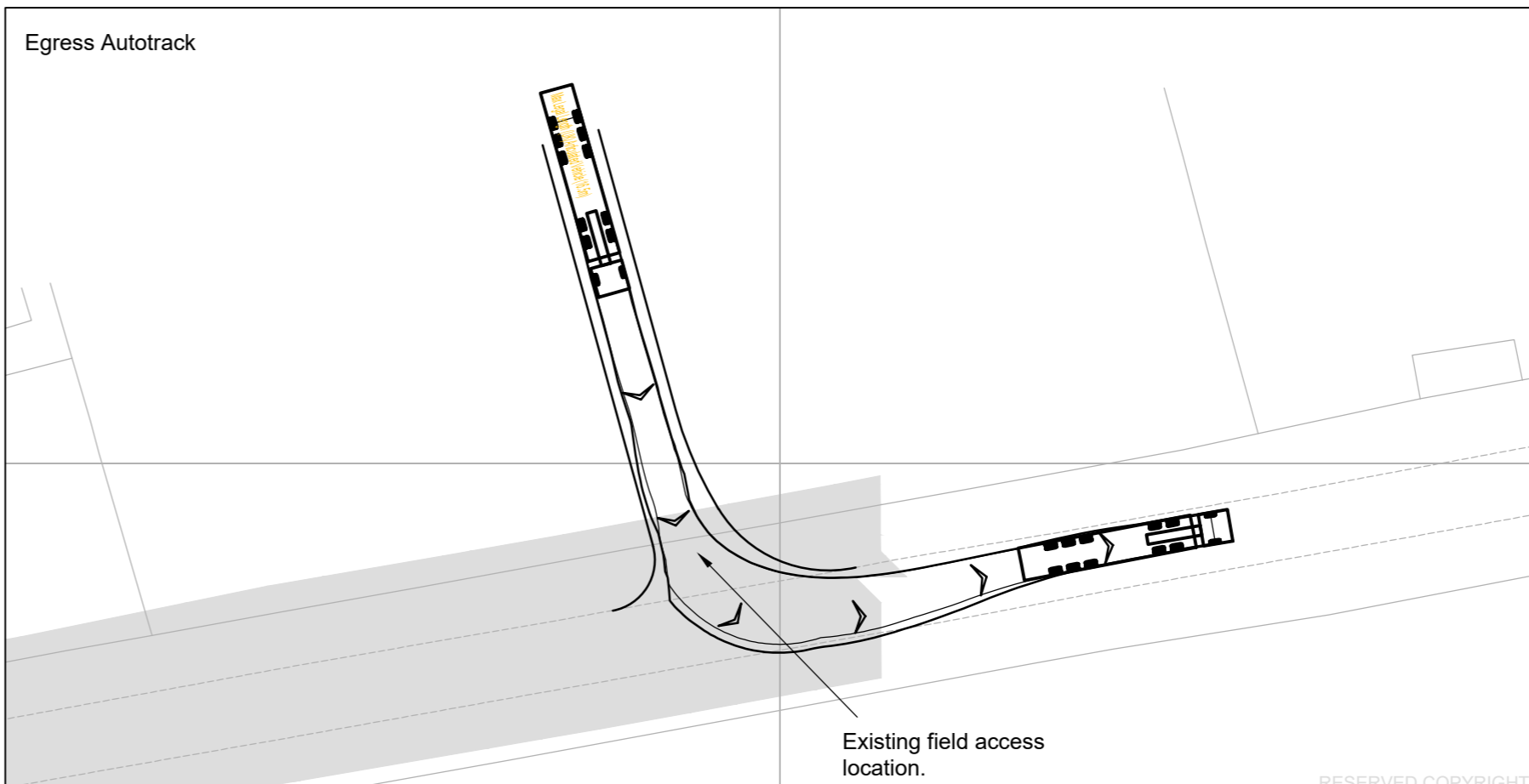

Egress Autotrack

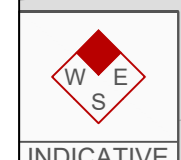

RESERVED COPYRIGHT

**A2**  
ORIGINAL  
PLOT SIZE

Reproduced from Ordnance Survey Superplan Data with the permission of The Controller of Her Majesty's Stationery Office. Crown Copyright - Licence No. AL100034021

- NOTES:**
1. The existing posted speed limit on Ingham Road is National Speed Limit (60mph).
  2. Visibility splays shown in accordance with DMRB CD 109.

**KEY**

 Approximate extent of adopted highway.

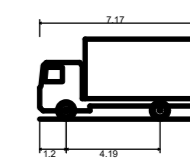

FTA Design 7.5 Tonne Rigid Vehicle (2016)

Overall Length	7.170m
Overall Width	2.300m
Overall Body Height	3.580m
Min Body Ground Clearance	0.375m
Track Width	2.120m
Lock to lock time	3.00s
Kerb to Kerb Turning Radius	7.000m

Rev	Date	Details	Drawn by	Checked by	Approved by
-	-	-	-	-	-

**Bristol**  
Cambridge  
London  
Manchester  
Oxford  
Welwyn Garden City



25 King Street  
Bristol  
BS1 4PB  
0117 925 9400  
[www.tpa.uk.com](http://www.tpa.uk.com)

CLIENT:  
**COTTAM SOLAR PROJECT LIMITED**

PROJECT:  
**COTTAM SOLAR FARM**

TITLE:  
**Cottam Solar Farm  
Access 9 - Operational  
Ingham Road**

STATUS:  
**INFORMATION**

SCALE: 1:500	DATE: 08.12.22	DRAWN: SG	CHECKED: RR	APPROVED: JD
-----------------	-------------------	--------------	----------------	-----------------

JOB NO: 2107-062	DRAWING NO: SK09	REVISION: -
---------------------	---------------------	----------------

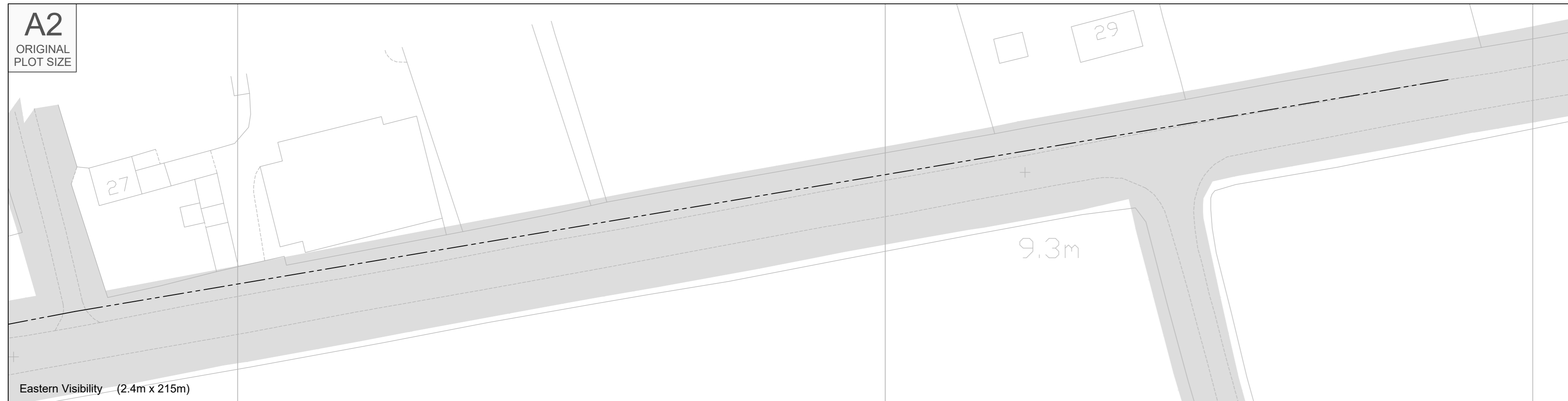

Eastern Visibility (2.4m x 215m)

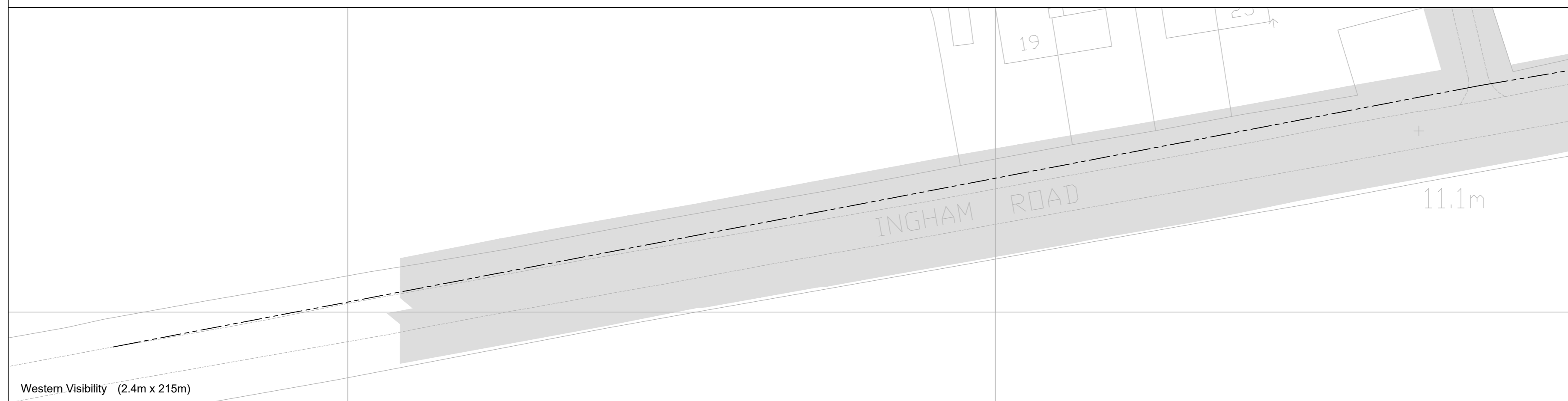

Western Visibility (2.4m x 215m)

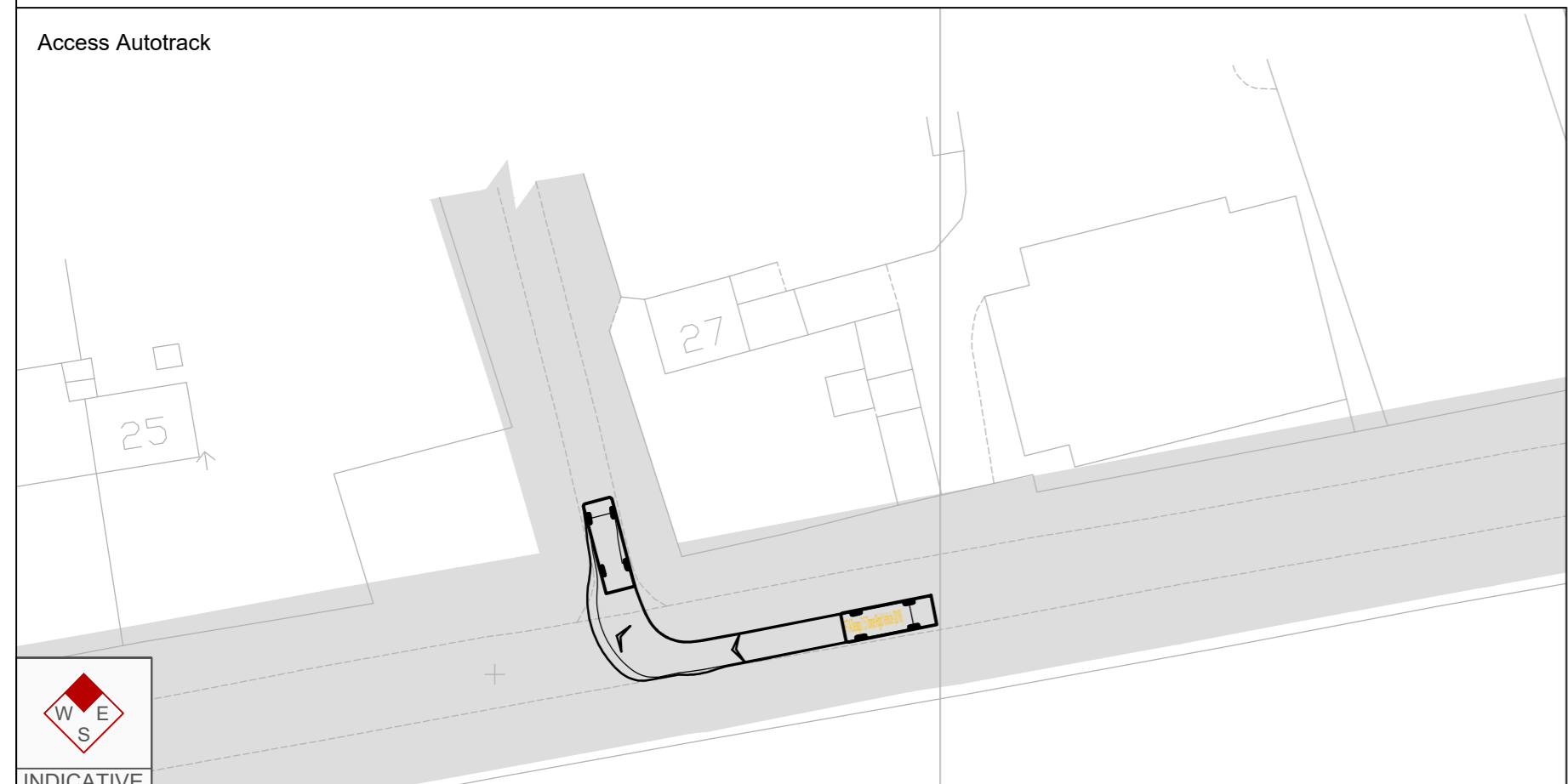

Access Autotrack

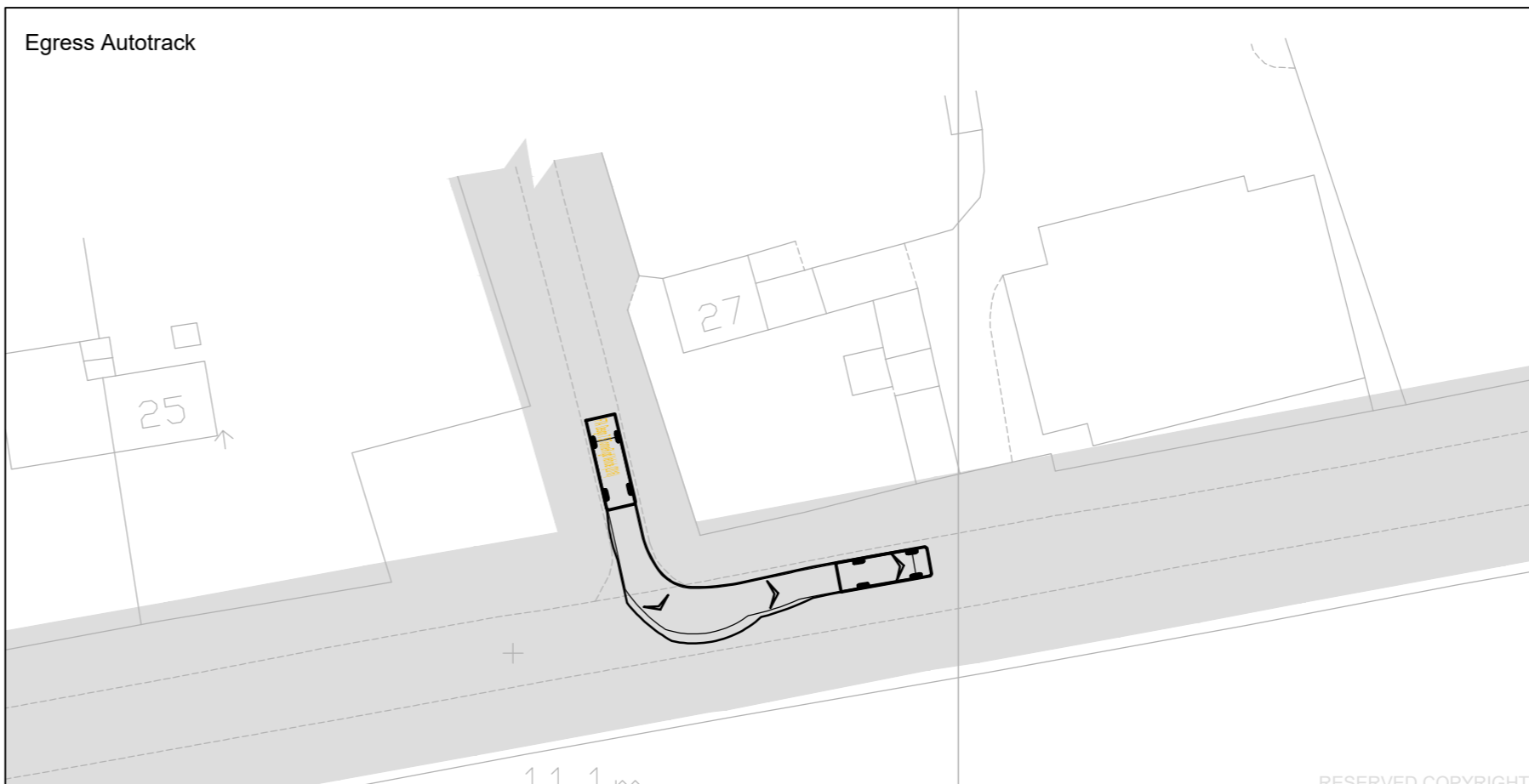

Egress Autotrack



INDICATIVE

RESERVED COPYRIGHT

**A2**  
ORIGINAL  
PLOT SIZE

Reproduced from Ordnance Survey Superplan Data with the permission of The Controller of Her Majesty's Stationery Office. Crown Copyright - Licence No. AL100034021

NOTES:

KEY

Approximate extent of adopted highway.

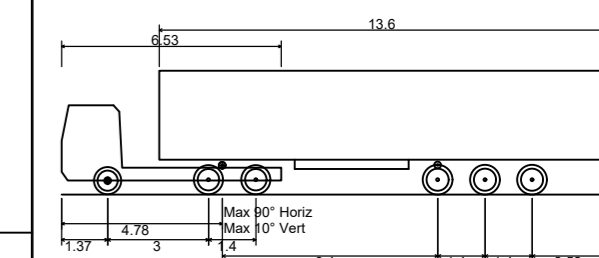

Max Legal Length (UK) Articulated Vehicle (16.5m)  
 Overall Length 16.500m  
 Overall Width 2.550m  
 Overall Body Height 3.681m  
 Min Body Ground Clearance 0.411m  
 Max Track Width 2.500m  
 Lock to lock time 6.00s  
 Kerb to Kerb Turning Radius 6.530m

Rev	Date	Details	Drawn by	Checked by	Approved by
-	-	-	-	-	-

Bristol  
 Cambridge  
 London  
 Manchester  
 Oxford  
 Welwyn Garden City



25 King Street  
 Bristol  
 BS1 4PB  
 0117 925 9400

[www.tpa.uk.com](http://www.tpa.uk.com)

CLIENT:  
**COTTAM SOLAR PROJECT LIMITED**

PROJECT:  
**COTTAM SOLAR FARM**

TITLE:  
**Cottam Solar Farm  
 Access 10  
 Coates Lane**

STATUS:  
**INFORMATION**

SCALE:	DATE:	DRAWN:	CHECKED:	APPROVED:
1:500	08.12.22	SG	RR	JD

JOB NO:	DRAWING NO:	REVISION:
2107-062	SK10	-

Eastern Visibility (2.4m x 107m)

Western Visibility (2.4m x 115m)

Access Autotrack

Egress Autotrack



INDICATIVE

RESERVED COPYRIGHT

**A2**  
ORIGINAL  
PLOT SIZE

Reproduced from Ordnance Survey Superplan Data with the permission of The Controller of Her Majesty's Stationery Office. Crown Copyright - Licence No. AL100034021

NOTES:

KEY

 Approximate extent of adopted highway.

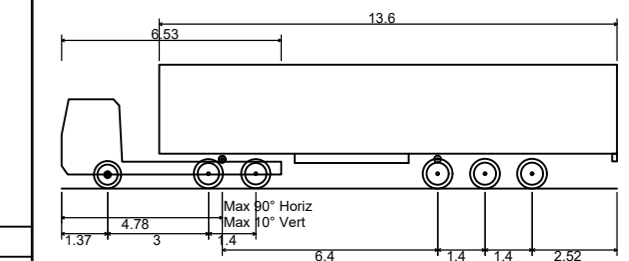

Max Legal Length (UK) Articulated Vehicle (16.5m)  
 Overall Length 16.500m  
 Overall Width 2.550m  
 Overall Body Height 3.681m  
 Min Body Ground Clearance 0.411m  
 Max Track Width 2.500m  
 Lock to lock time 6.00s  
 Kerb to Kerb Turning Radius 6.530m

Rev	Date	Details	Drawn by	Checked by	Approved by
-	-	-	-	-	-

Bristol  
 Cambridge  
 London  
 Manchester  
 Oxford  
 Welwyn Garden City



25 King Street  
 Bristol  
 BS1 4PB  
 0117 925 9400

[www.tpa.uk.com](http://www.tpa.uk.com)

CLIENT:  
**COTTAM SOLAR PROJECT LIMITED**

PROJECT:  
**COTTAM SOLAR FARM**

TITLE:  
**Cottam Solar Farm  
 Access 11  
 Coates Lane**

STATUS:  
**INFORMATION**

SCALE: 1:500	DATE: 08.12.22	DRAWN: SG	CHECKED: RR	APPROVED: JD
JOB NO: 2107-062	DRAWING NO: SK11		REVISION: -	

Eastern Visibility (2.4m x 215m)

Western Visibility (2.4m x 215m)

Access Autotrack

Egress Autotrack



INDICATIVE

RESERVED COPYRIGHT

**A2**  
ORIGINAL  
PLOT SIZE

2.4m x 215m visibility splay.

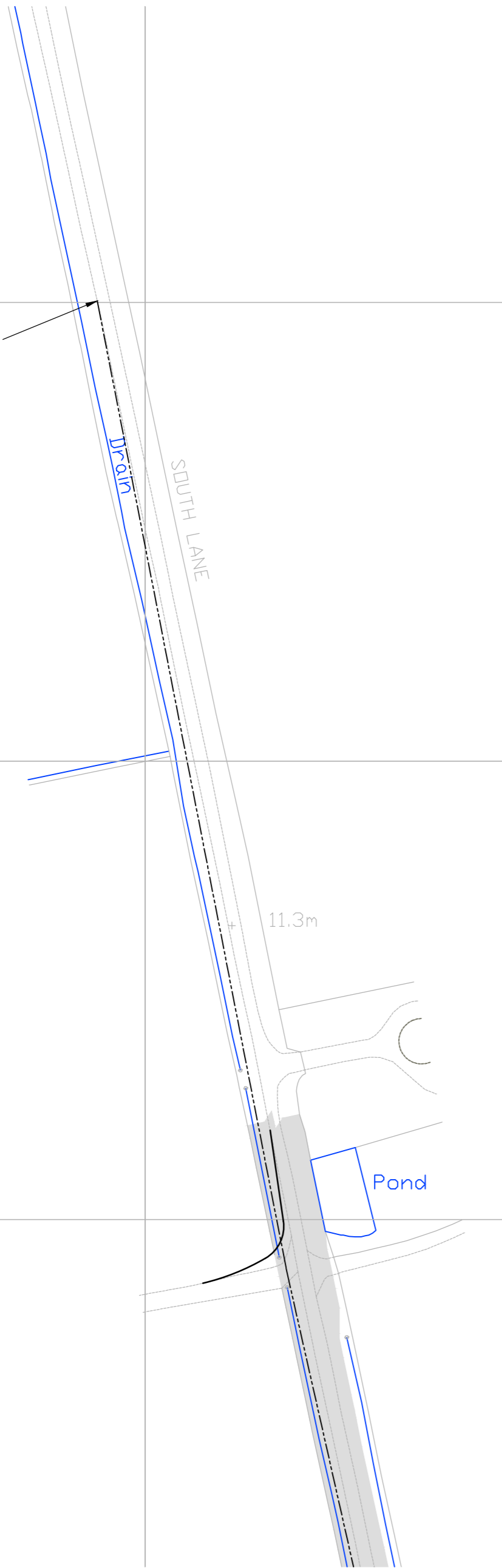

**Site Access Arrangement And Visibility  
Splay To The North**

Scale 1:1,000

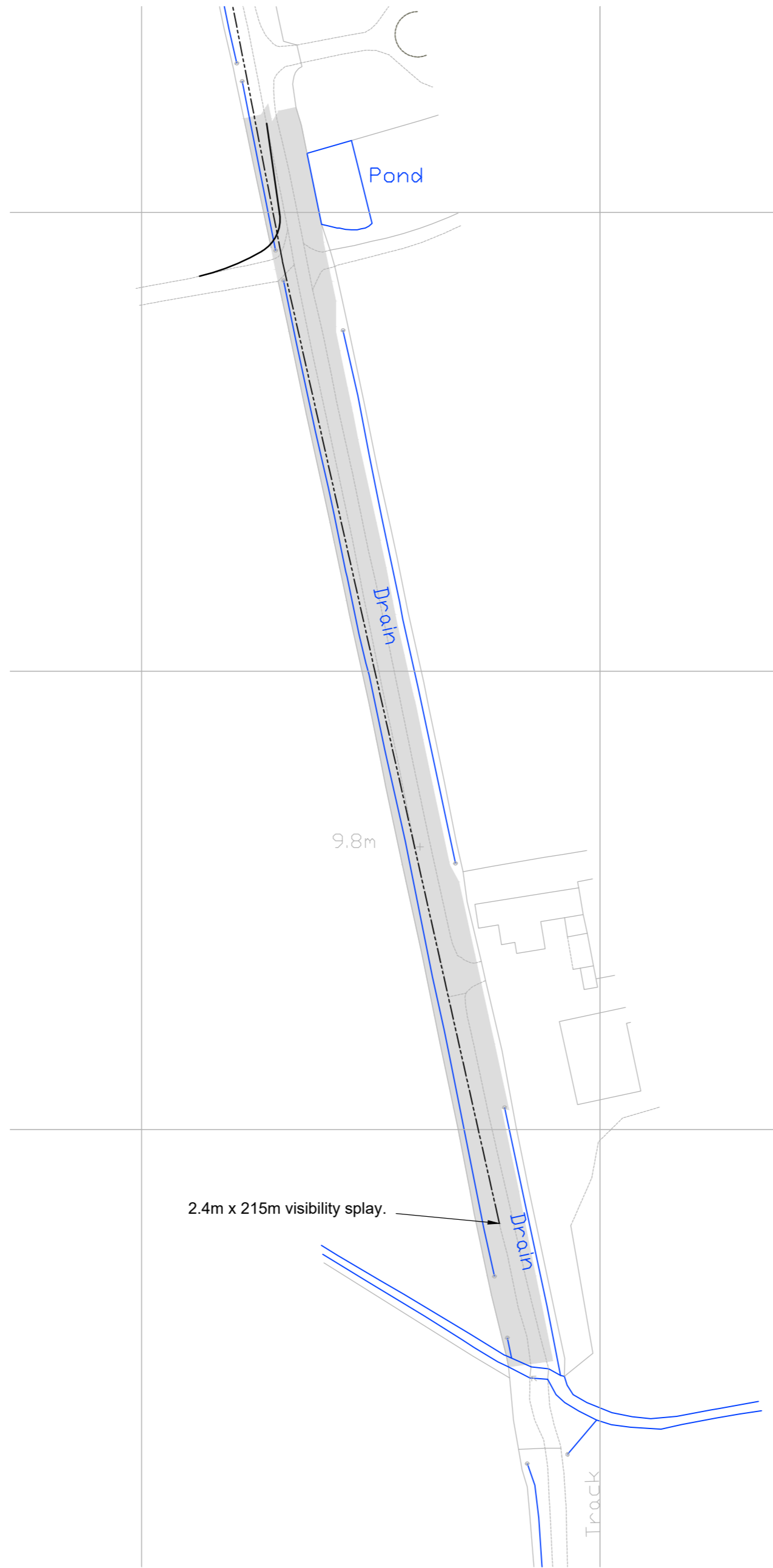

**Site Access Arrangement And Visibility  
Splay To The North**

Scale 1:1,000

South Lane to be widened to accommodate swept paths of an articulated HGV.

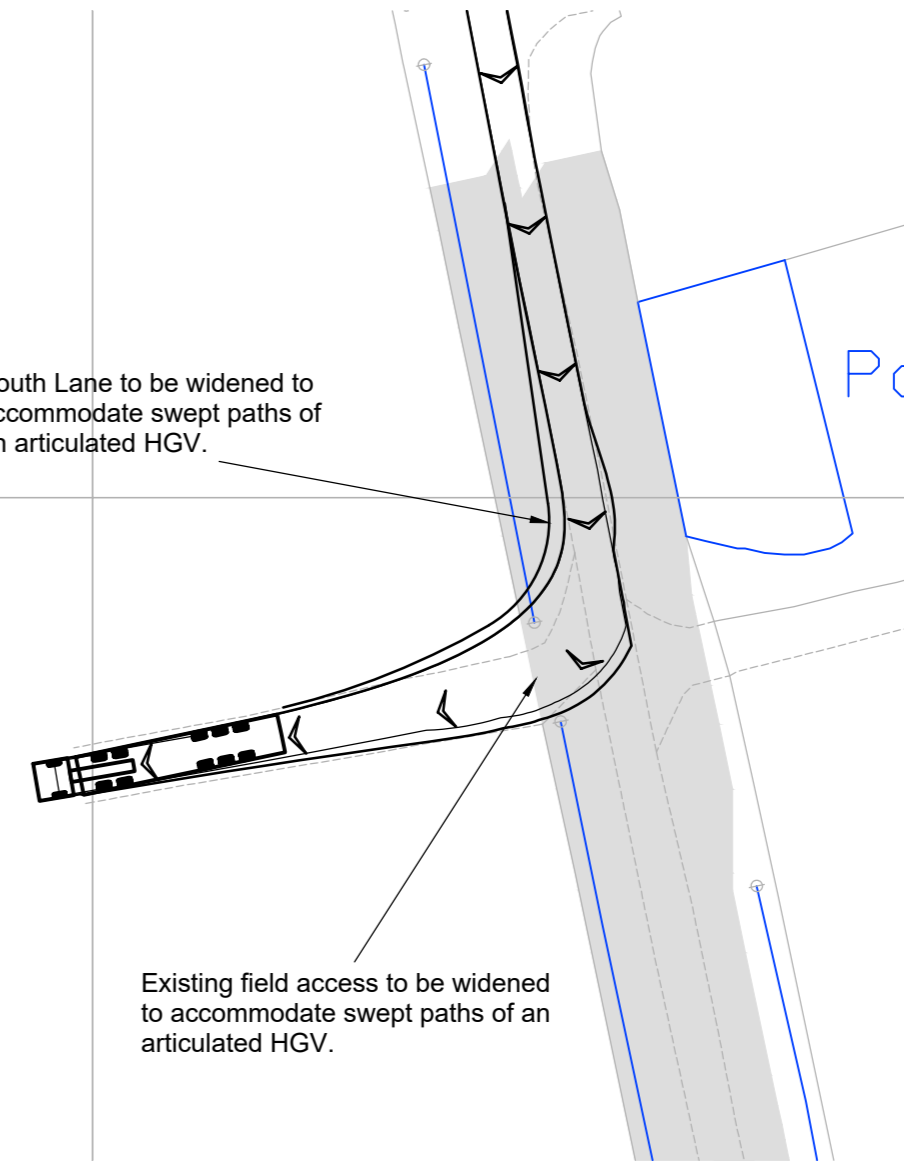

**Swept Path Of An Articulated HGV  
Entering Site Access**

Scale 1:500

South Lane to be widened to accommodate swept paths of an articulated HGV.

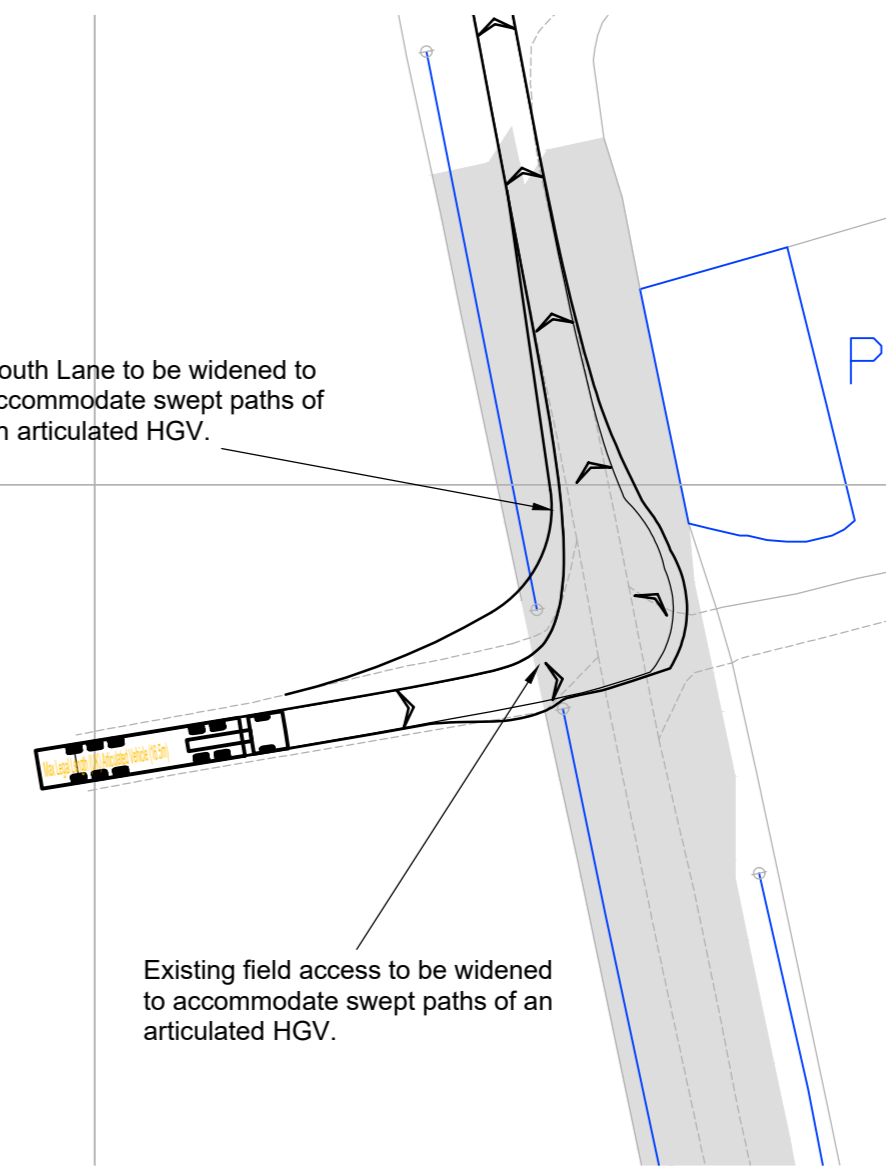

**Swept Path Of An Articulated HGV  
Egressing Site Access**

Scale 1:500

Reproduced from Ordnance Survey Superplan Data with the permission of The Controller of Her Majesty's Stationery Office. Crown Copyright - Licence No. AL100034021

NOTES:

KEY

Approximate extent of adopted highway.

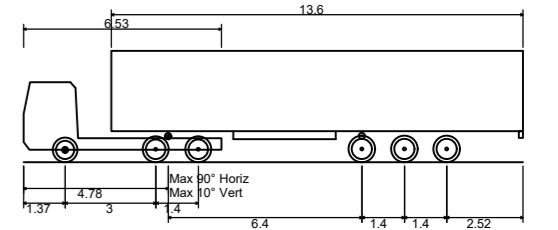

Max Legal Length (UK) Articulated Vehicle (16.5m)  
Overall Length 16.500m  
Overall Width 2.550m  
Overall Body Height 3.881m  
Min Body Ground Clearance 0.411m  
Max Track Width 2.500m  
Lock to lock time 6.00s  
Kerb to Kerb Turning Radius 6.530m

Rev	Date	Details	Drawn by	Checked by	Approved by
-	-	-	-	-	-

Bristol  
Cambridge  
London  
Manchester  
Oxford  
Welwyn Garden City



25 King Street  
Bristol  
BS1 4PB  
0117 925 9400  
[www.tpa.uk.com](http://www.tpa.uk.com)

CLIENT:  
**COTTAM SOLAR PROJECT LIMITED**

PROJECT:  
**COTTAM SOLAR FARM**

TITLE:  
**Cottam Solar Farm  
Access 12  
South Lane**

STATUS:  
**INFORMATION**

SCALE:	DATE:	DRAWN:	CHECKED:	APPROVED:
As Shown	08.12.22	AJS	WG	JD
JOB NO:	DRAWING NO:	REVISION:		
2107-062	SK12	-		

RESERVED COPYRIGHT



**A2**  
ORIGINAL  
PLOT SIZE

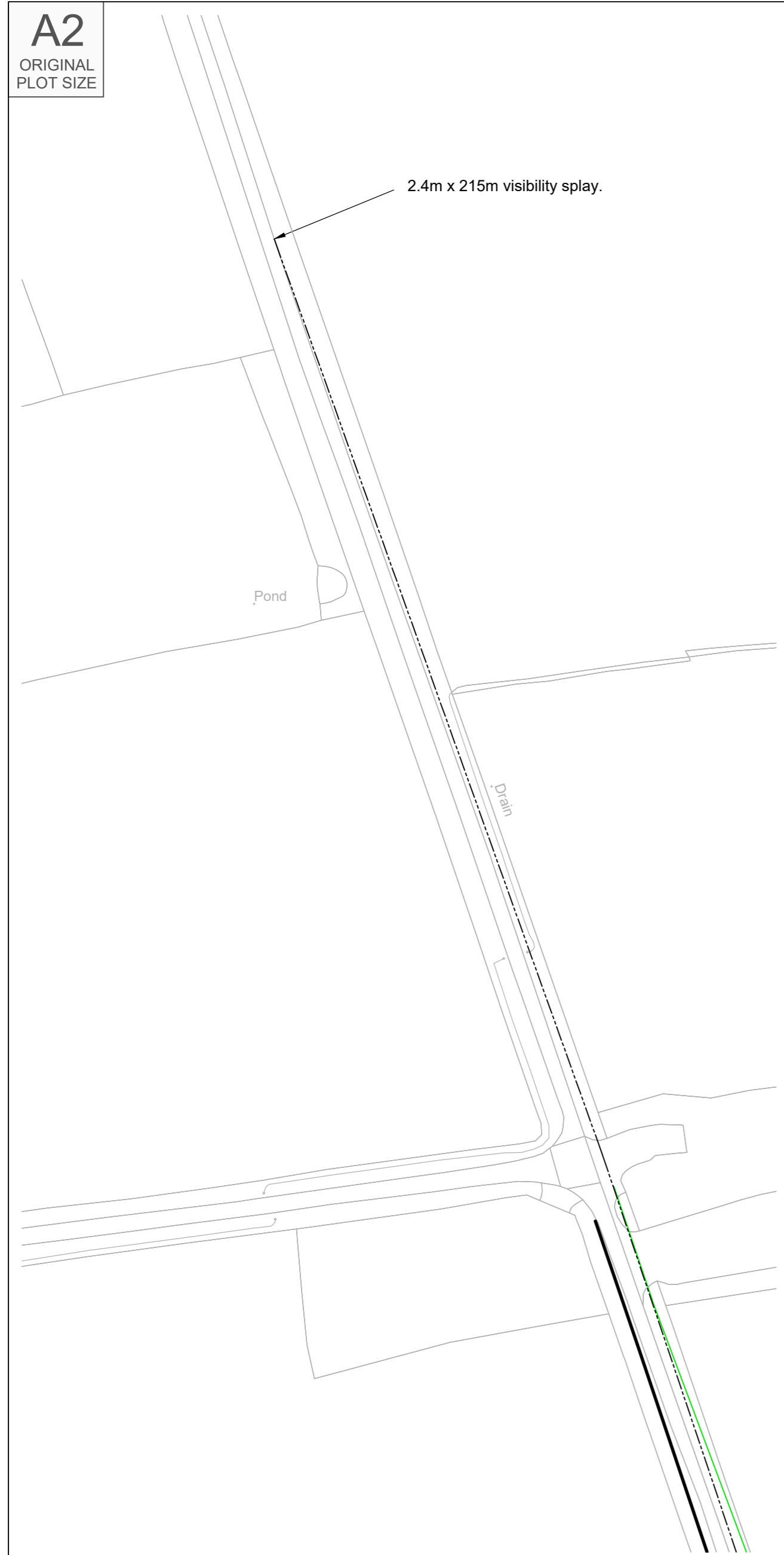

**Site Access Arrangement And Visibility  
Splay To The North**  
Scale 1:1,000

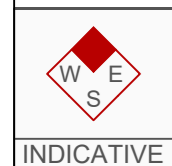

**Site Access Arrangement And Visibility  
Splay To The North**  
Scale 1:1,000



**Site Access**  
Scale 1:500

Reproduced from Ordnance Survey Superplan Data with the permission of The Controller of Her Majesty's Stationery Office. Crown Copyright - Licence No. AL100034021

NOTES:

Rev	Date	Details	Drawn by	Checked by	Approved by
-	-	-	-	-	-

**Bristol**  
 Cambridge  
 London  
 Manchester  
 Oxford  
 Welwyn Garden City



Transport Planning Associates  
  
 25 King Street  
 Bristol  
 BS1 4PB  
 0117 925 9400  
[www.tpa.uk.com](http://www.tpa.uk.com)

CLIENT:  
**COTTAM SOLAR PROJECT LIMITED**

PROJECT:  
**COTTAM SOLAR FARM**

TITLE:  
**Cottam Solar Farm  
Access 13  
Stone Pit Lane**

STATUS:  
**INFORMATION**

SCALE:	DATE:	DRAWN:	CHECKED:	APPROVED:
As Shown	14.12.22	SG	RR	JD
JOB NO:	DRAWING NO:	REVISION:		
2107-062	SK13	-		

RESERVED COPYRIGHT



**A2**  
ORIGINAL  
PLOT SIZE

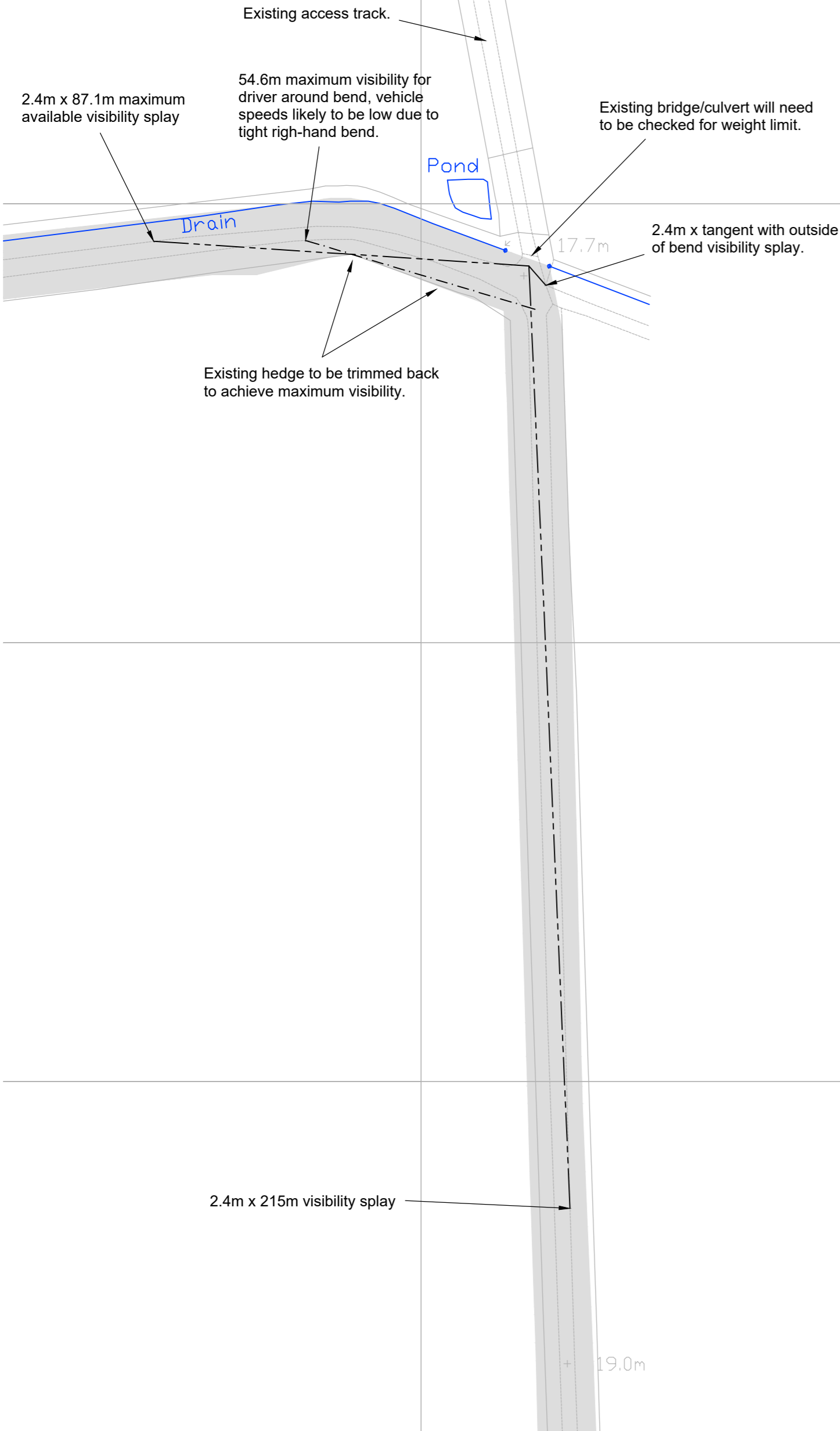

**Site Access Arrangement**

Scale 1:1000

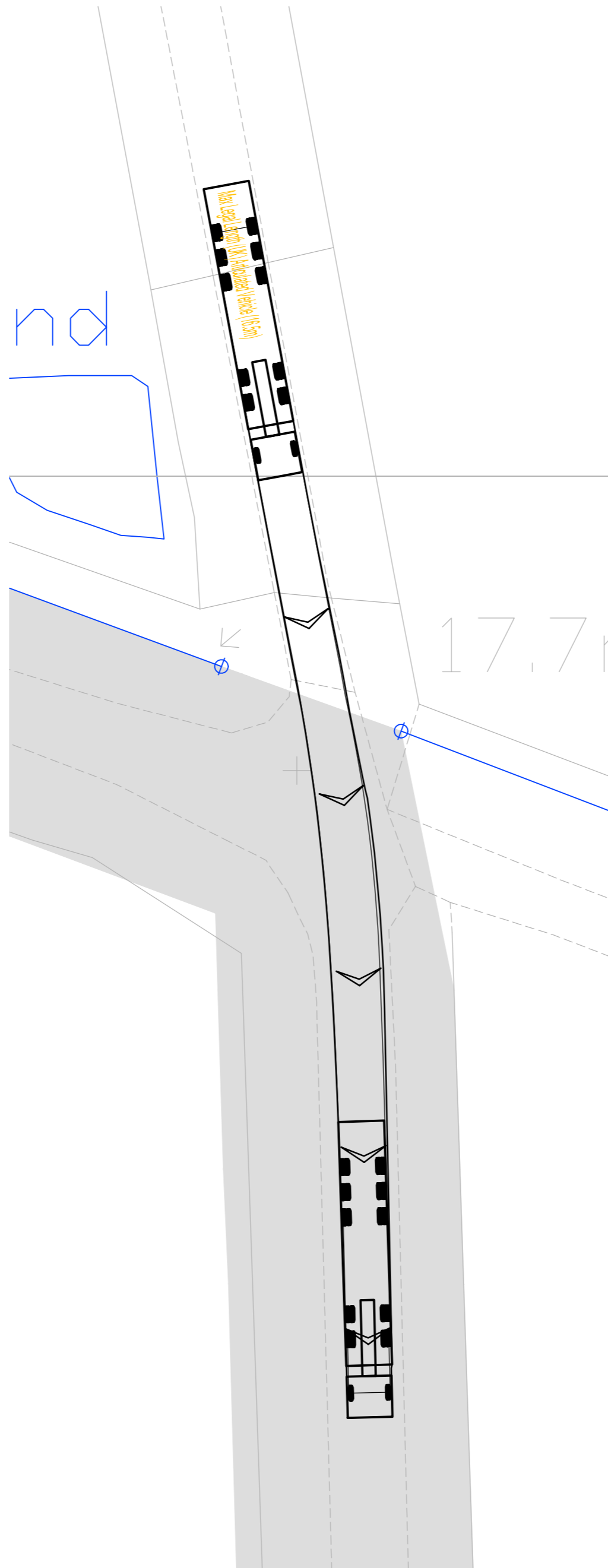

**16.5m Articulated Vehicle Entering Site**

Scale 1:250

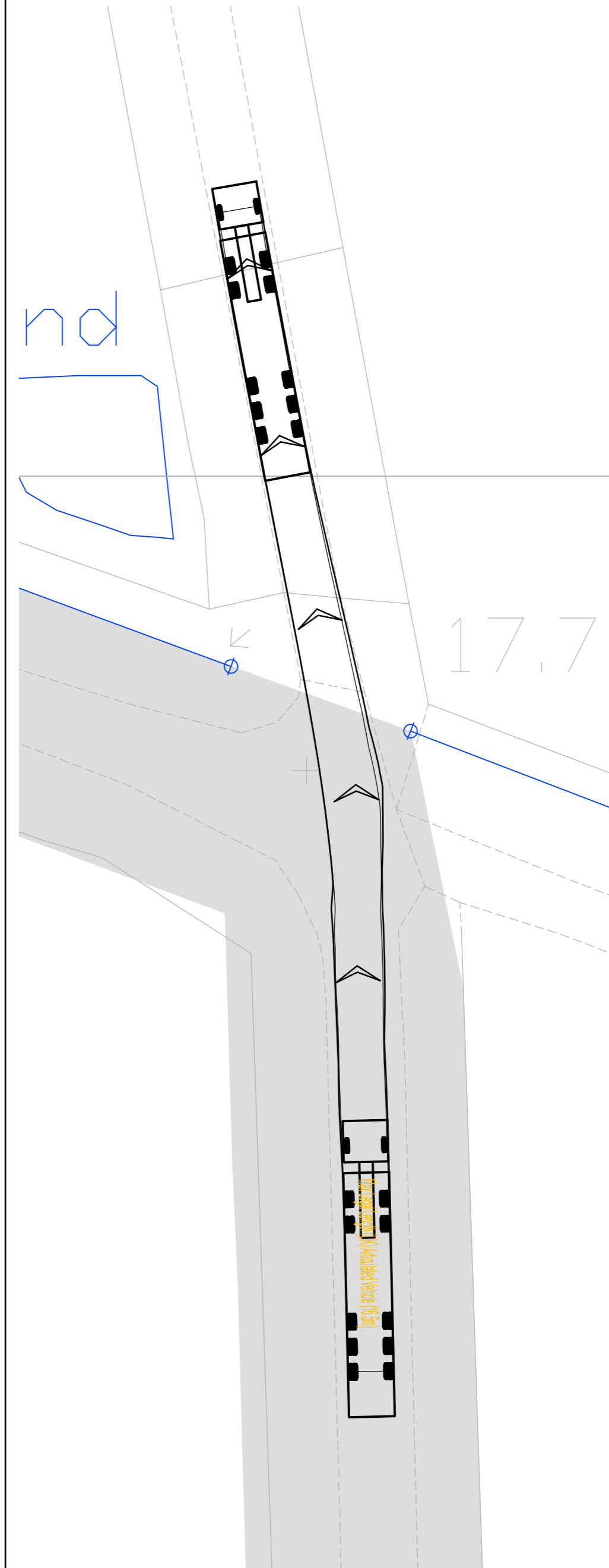

**16.5m Articulated Vehicle Leaving Site**

Scale 1:250

Reproduced from Ordnance Survey Superplan Data with the permission of The Controller of Her Majesty's Stationery Office. Crown Copyright - Licence No. AL100034021

NOTES:  
1. The existing posted speed limit is National Speed Limit (60mph).

KEY  
Approximate extent of adopted highway.

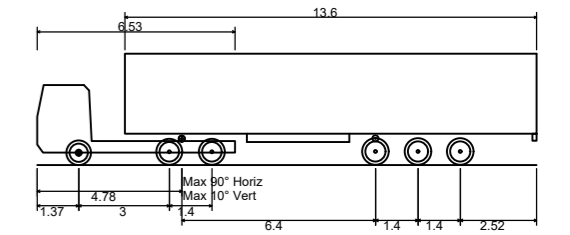

Max Legal Length (UK) Articulated Vehicle (16.5m)  
Overall Length 16.500m  
Overall Width 2.550m  
Overall Body Height 3.681m  
Min Body Ground Clearance 0.411m  
Max Track Width 2.500m  
Lock to lock time 6.00s  
Kerb to Kerb Turning Radius 6.530m

Rev	Date	Details	Drawn by	Checked by	Approved by
-	-	-	-	-	-

Bristol  
Cambridge  
London  
Manchester  
Oxford  
Welwyn Garden City

25 King Street  
Bristol  
BS1 4PB  
0117 925 9400  
[www.tpa.uk.com](http://www.tpa.uk.com)

CLIENT:  
**COTTAM SOLAR PROJECT LIMITED**

PROJECT:  
**COTTAM SOLAR FARM**

TITLE:  
**Cottam Solar Farm  
Access 14  
Un-Named Track**

STATUS:  
**INFORMATION**

SCALE: As Shown	DATE: 08.12.22	DRAWN: PSW	CHECKED: WG	APPROVED: JD
JOB NO: 2107-062	DRAWING NO: SK14		REVISION: -	

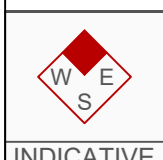

A2  
ORIGINAL  
PLOT SIZE

Reproduced from Ordnance Survey Superplan Data with the permission of The Controller of Her Majesty's Stationery Office. Crown Copyright - Licence No. AL100034021

NOTES:  
1. The existing posted speed limit on B1205 Kirton Road is National Speed Limit (60mph).

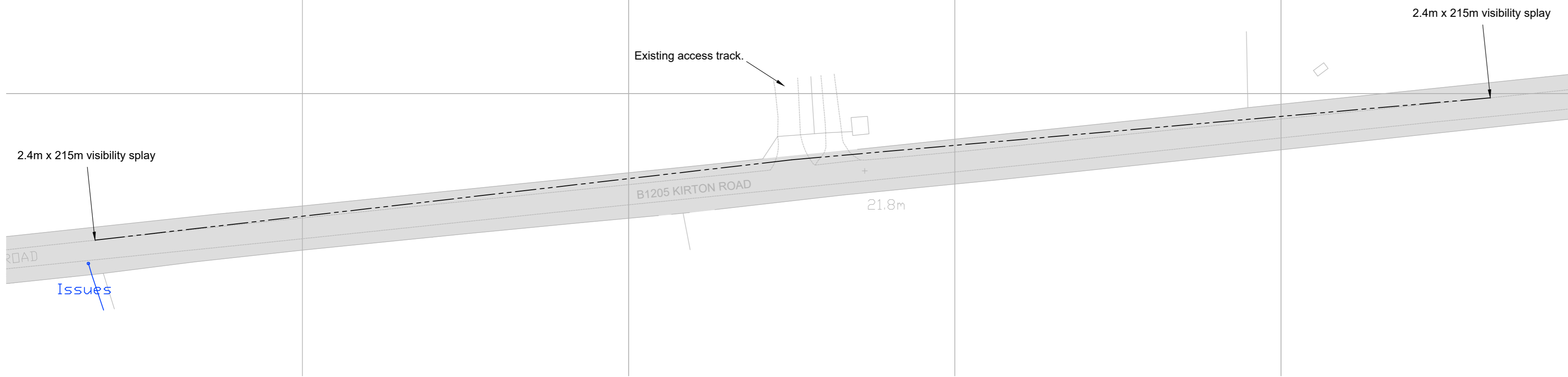

KEY  
Approximate extent of adopted highway.

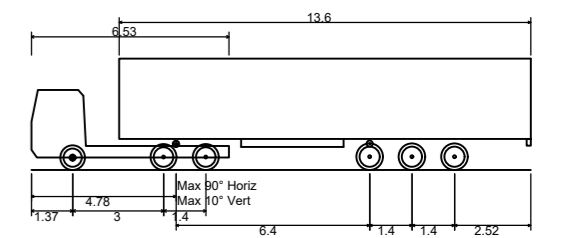

Max Legal Length (UK) Articulated Vehicle (16.5m)  
Overall Length 16.500m  
Overall Width 2.550m  
Overall Body Height 3.681m  
Min Body Ground Clearance 0.411m  
Max Track Width 2.500m  
Lock to lock time 6.00s  
Kerb to Kerb Turning Radius 6.530m

**Site Access Arrangement**  
Scale 1:1000

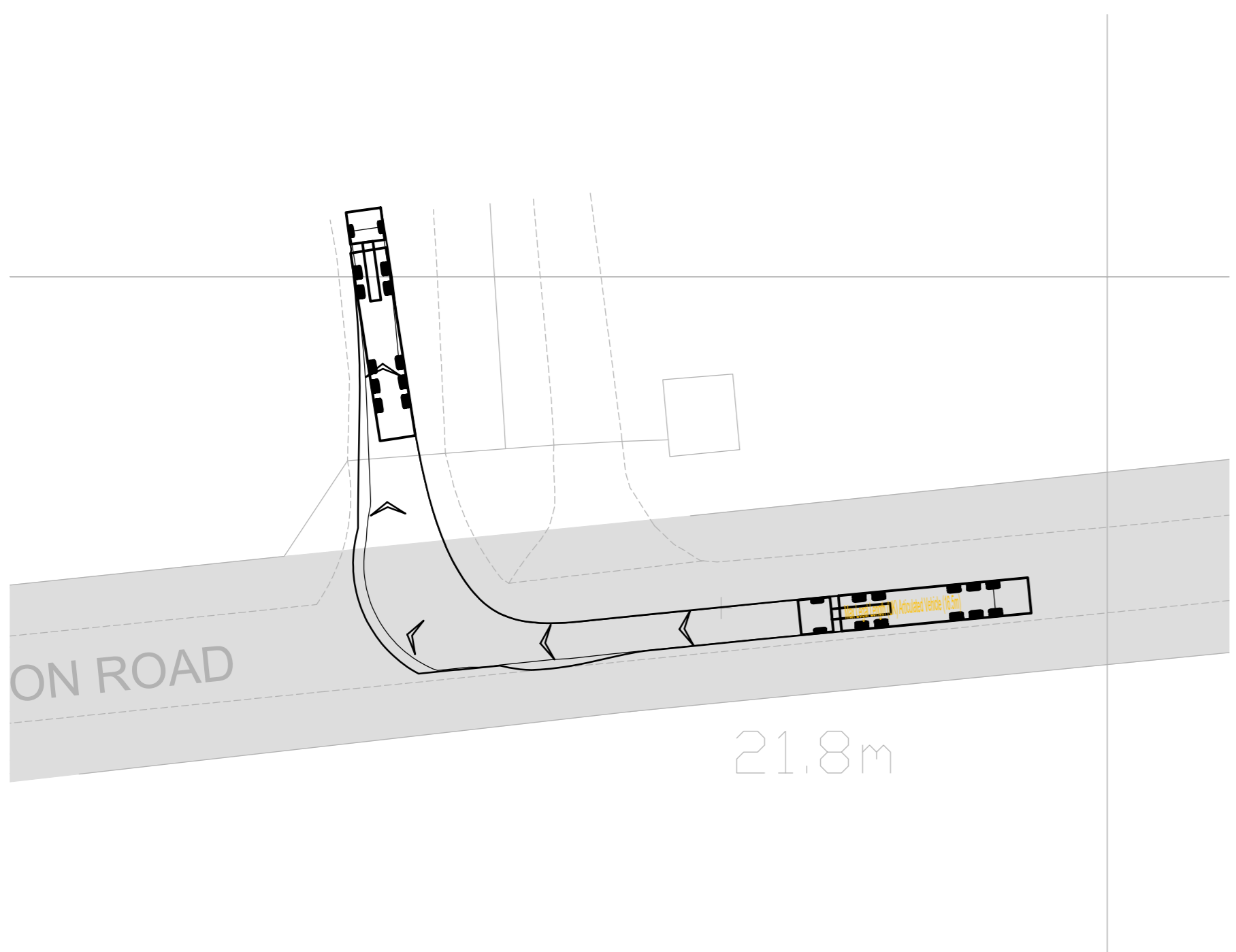

**16.5m Articulated Vehicle Turning Right Into Access**  
Scale 1:250

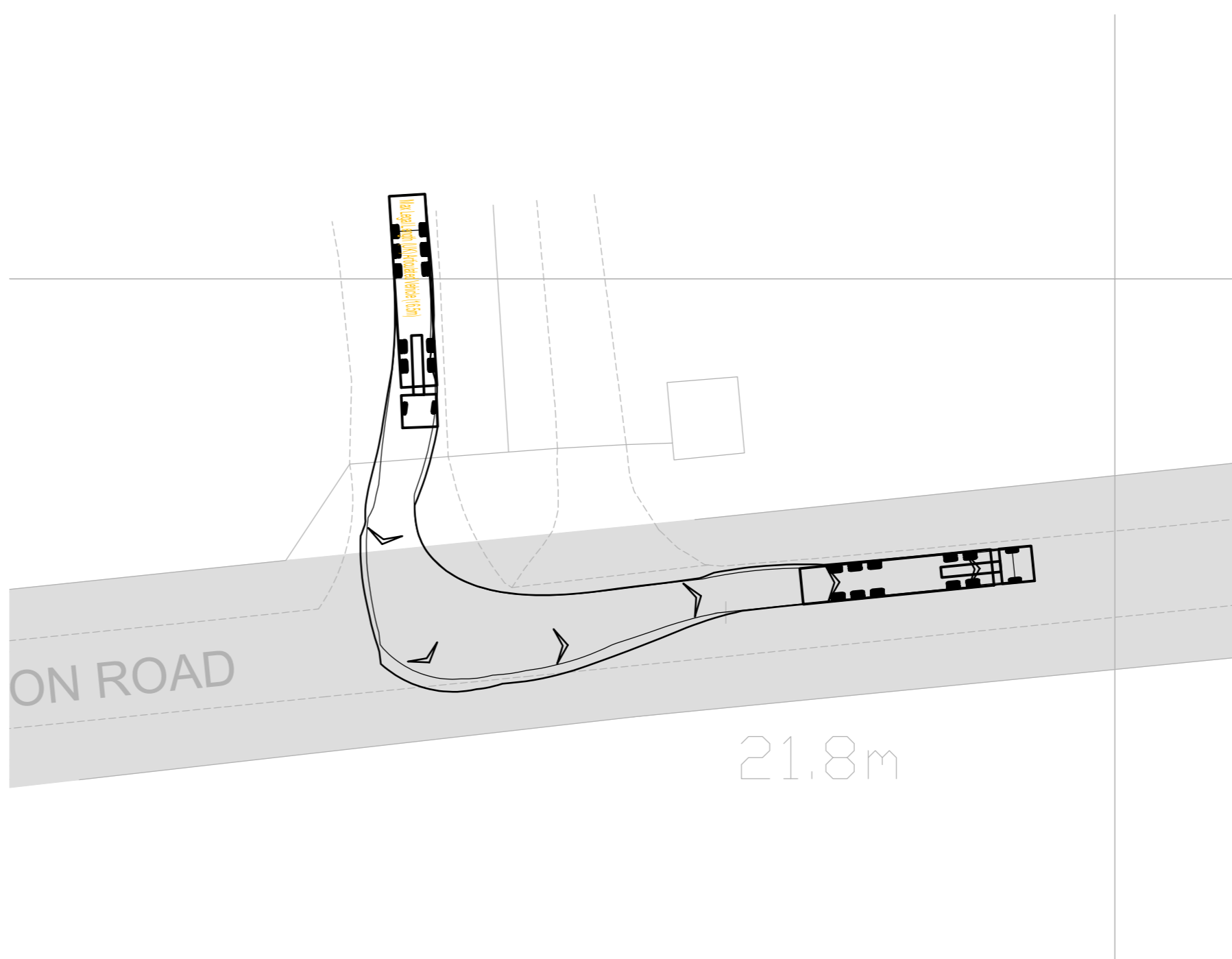

**16.5m Articulated Vehicle Turning Left Out Of Access**  
Scale 1:250

Rev	Date	Details	Drawn by	Checked by	Approved by
-	-	-	-	-	-

**Bristol**  
Cambridge  
London  
Manchester  
Oxford  
Welwyn Garden City

**tpa**  
Transport Planning Associates

25 King Street  
Bristol  
BS1 4PB  
0117 925 9400  
[www.tpa.uk.com](http://www.tpa.uk.com)

CLIENT:  
**COTTAM SOLAR PROJECT LIMITED**

PROJECT:  
**COTTAM SOLAR FARM**

TITLE:  
**Cottam Solar Farm  
Access 15  
B1205 Kirton Road**

STATUS:  
**INFORMATION**

SCALE: As Shown	DATE: 08.12.22	DRAWN: PSW	CHECKED: WG	APPROVED: JD
JOB NO: 2107-062	DRAWING NO: SK15	REVISION: -		

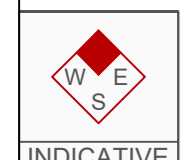

RESERVED COPYRIGHT

A2  
ORIGINAL  
PLOT SIZE

2.4m x 215m visibility splay

Existing access track.

2.4m x 215m visibility splay

KIRTON ROAD

21.5m

20.6m

**Site Access Arrangement**

Scale 1:1000

Reproduced from Ordnance Survey Superplan Data with the permission of The Controller of Her Majesty's Stationery Office. Crown Copyright - Licence No. AL100034021

NOTES:

1. The existing posted speed limit on B1205 Kirton Road is National Speed Limit (60mph).

KEY

Approximate extent of adopted highway.

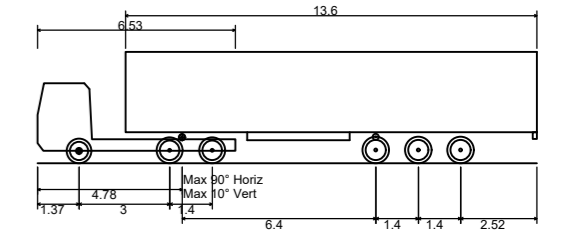

Max Legal Length (UK) Articulated Vehicle (16.5m)  
 Overall Length 16.500m  
 Overall Width 2.550m  
 Overall Body Height 3.681m  
 Min Body Ground Clearance 0.411m  
 Max Track Width 2.500m  
 Lock to lock time 6.00s  
 Kerb to Kerb Turning Radius 6.530m

Rev	Date	Details	Drawn by	Checked by	Approved by
-	-	-	-	-	-

Bristol  
 Cambridge  
 London  
 Manchester  
 Oxford  
 Welwyn Garden City



25 King Street  
 Bristol  
 BS1 4PB  
 0117 925 9400  
[www.tpa.uk.com](http://www.tpa.uk.com)

CLIENT:  
**COTTAM SOLAR PROJECT LIMITED**

PROJECT:  
**COTTAM SOLAR FARM**

TITLE:  
**Cottam Solar Farm  
 Access 16  
 B1205 Kirton Road**

STATUS:  
**INFORMATION**

SCALE: As Shown	DATE: 08.12.22	DRAWN: PSW	CHECKED: WG	APPROVED: JD
JOB NO: 2107-062	DRAWING NO: SK16		REVISION: -	

Existing access to be widened to accommodate swept paths of articulated HGV, existing culvert to be widened and hedge trimmed as required.

Existing access to be widened to accommodate swept paths of articulated HGV, existing culvert to be widened and hedge trimmed as required.

**16.5m Articulated Vehicle Turning Right Into Access**

Scale 1:250

**16.5m Articulated Vehicle Turning Left Out Of Access**

Scale 1:250

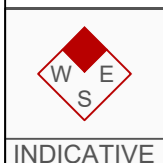

INDICATIVE

RESERVED COPYRIGHT

A2  
ORIGINAL  
PLOT SIZE

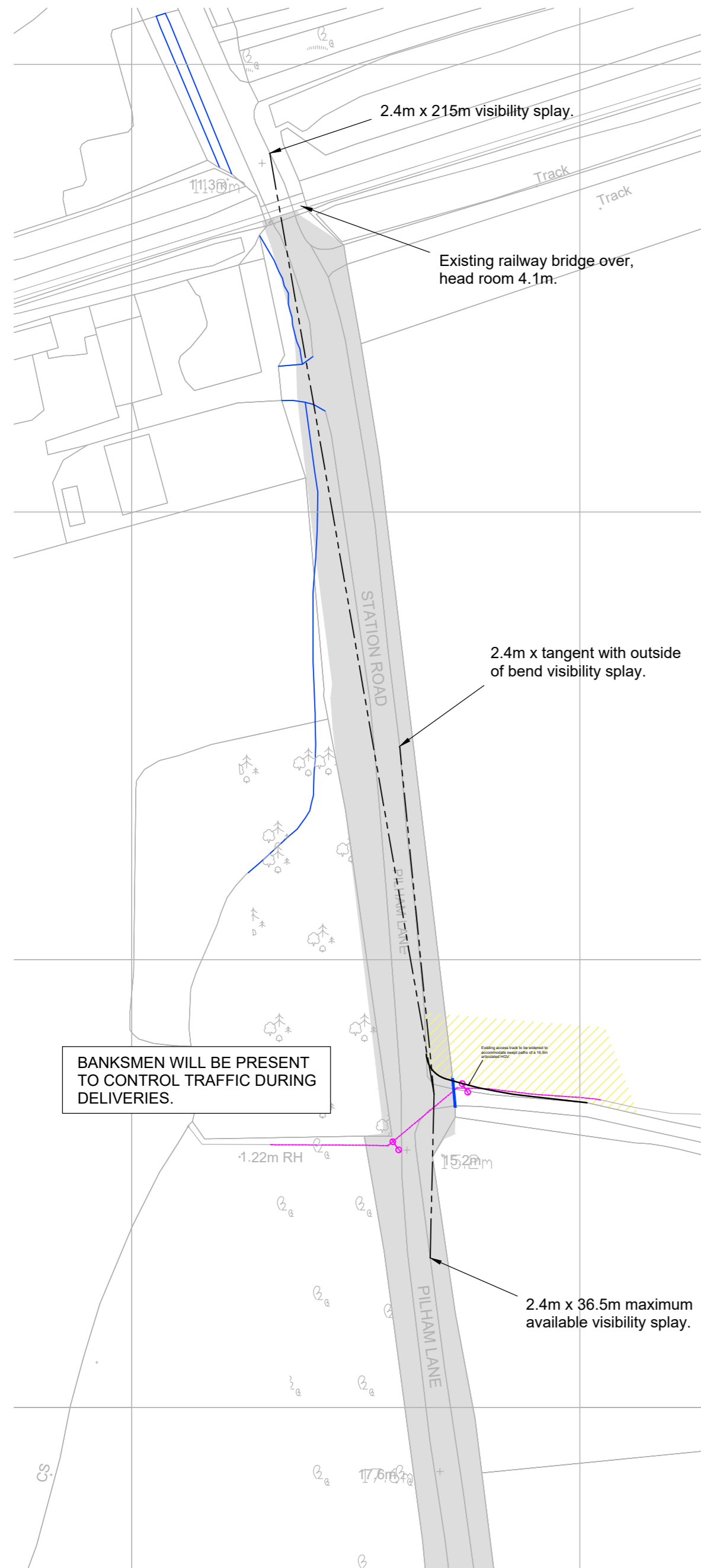

**Site Access Arrangement**

Scale 1:1,000

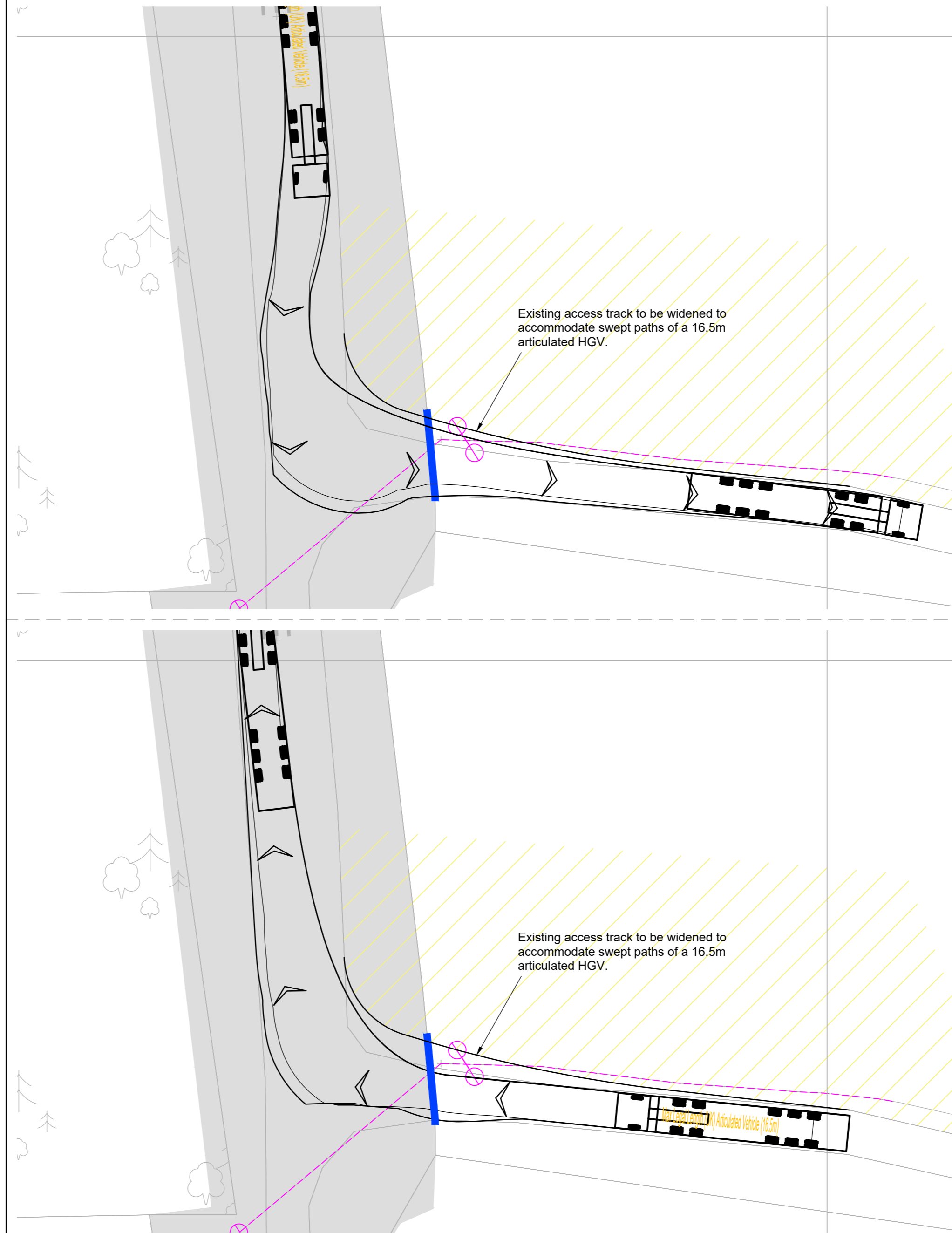

**Swept Paths Of A 16.5m Articulated Vehicle**

Scale 1:250

Reproduced from Ordnance Survey Superplan Data with the permission of The Controller of Her Majesty's Stationery Office. Crown Copyright - Licence No. AL100034021

NOTES:

1. The existing posted speed limit on Station Road is National Speed Limit (60mph).

KEY

- Approximate extent of adopted highway. Existing field
- access gate.
- Potential area required for abnormal vehicle access

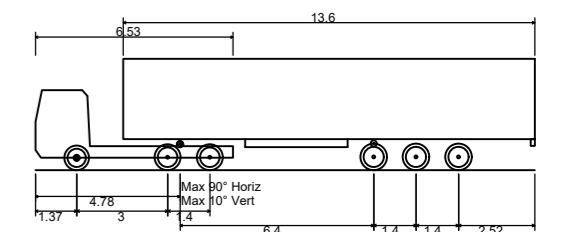

Max Legal Length (UK) Articulated Vehicle (16.5m) 16.500m  
 Overall Length 16.500m  
 Overall Width 2.550m  
 Overall Body Height 3.681m  
 Min Body Ground Clearance 0.411m  
 Max Track Width 2.500m  
 Lock to lock time 6.00s  
 Kerb to Kerb Turning Radius 6.530m

Rev	Date	Details	Drawn by	Checked by	Approved by
-	-	-	-	-	-

Bristol  
 Cambridge  
 London  
 Manchester  
 Oxford  
 Welwyn Garden City



25 King Street  
 Bristol  
 BS1 4PB  
 0117 925 9400

[www.tpa.uk.com](http://www.tpa.uk.com)

CLIENT:  
**COTTAM SOLAR PROJECT LIMITED**

PROJECT:  
**COTTAM SOLAR FARM**

TITLE:  
**Cottam Solar Farm  
 Access 17  
 Station Road**

STATUS:  
**INFORMATION**

SCALE: As Shown	DATE: 14.12.22	DRAWN: SG	CHECKED: RR	APPROVED: JD
JOB NO: 2107-062	DRAWING NO: SK17		REVISION: -	

RESERVED COPYRIGHT

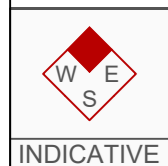

# APPENDIX C

**A3**  
ORIGINAL  
PLOT SIZE

Banksman to assist accessing  
and egressing vehicles

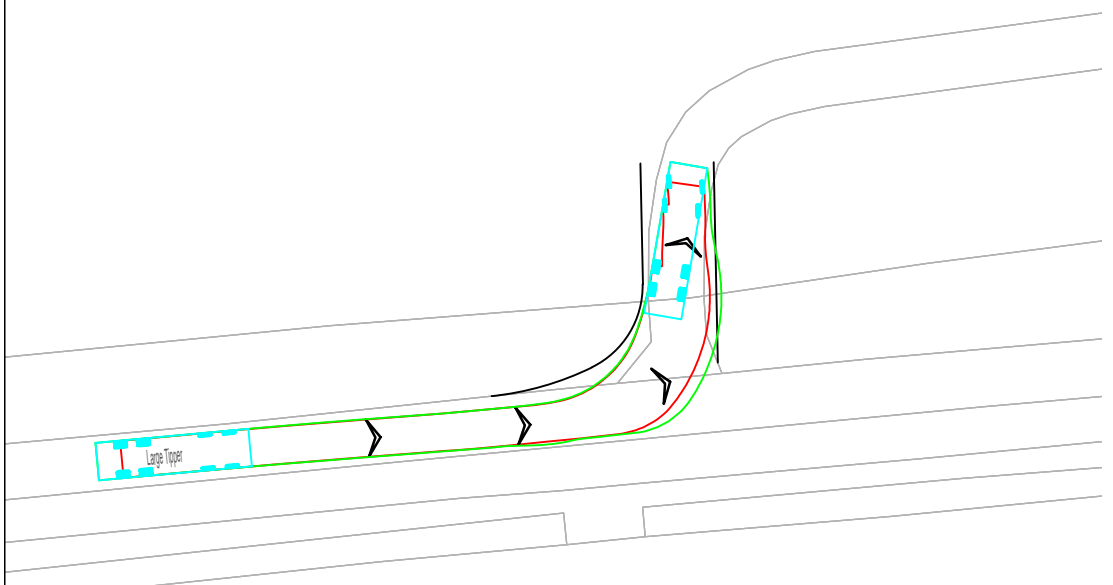

Tipper Vehicle Entering Site  
Scale 1:500

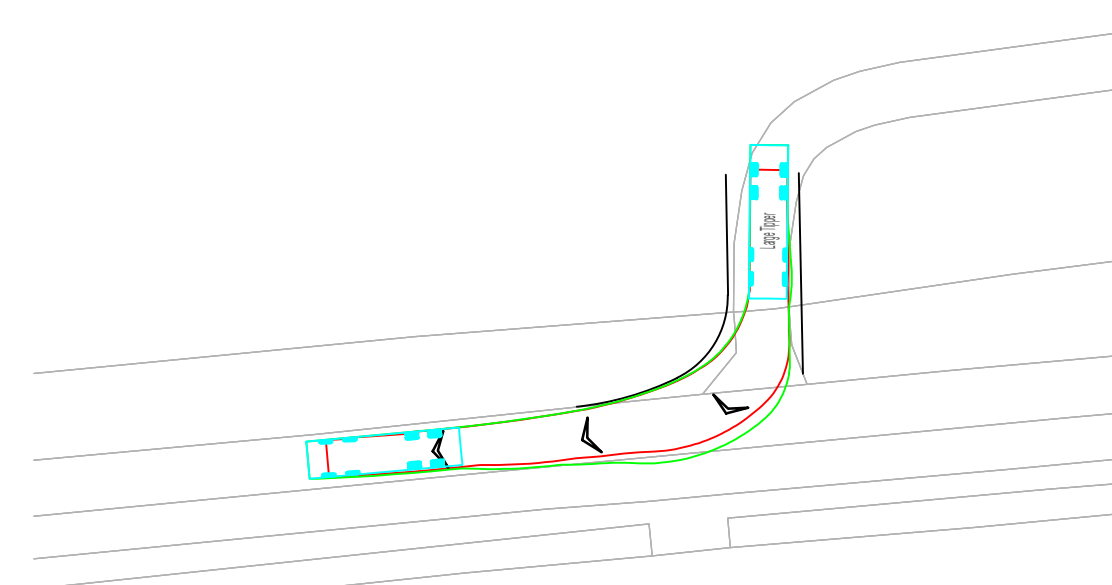

Tipper Vehicle Exiting Site  
Scale 1:500

Reproduced from Ordnance Survey Superplan Data with the permission of The Controller of Her Majesty's Stationery Office. Crown Copyright - Licence No. AL100034021

- NOTES:
1. The existing posted speed limit on Torksey Ferry Road is National Speed Limit (60mph)
  2. OS base to be confirmed with topographical survey
  3. Highway boundary to be confirmed

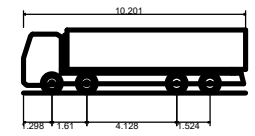

Large Tipper	10.201m
Overall Length	2.495m
Overall Width	2.890m
Overall Body Height	0.341m
Min Body Ground Clearance	2.471m
Track Width	6.00s
Lock to lock time	11.550m
Kerb to Kerb Turning Radius	

Rev	Date	Details	Drawn by	Checked by	Approved by
-	-	-	-	-	-

Bristol  
Cambridge  
London  
Manchester  
Oxford  
Welwyn Garden City



25 King Street  
Bristol  
BS1 4PB  
0117 925 9400  
[www.tpa.uk.com](http://www.tpa.uk.com)

CLIENT:  
**COTTAM SOLAR PROJECT LIMITED**

PROJECT:  
**COTTAM SOLAR FARM**

TITLE:  
**Cable Route Access Point 01**

STATUS:  
**INFORMATION**

SCALE:	DATE:	DRAWN:	CHECKED:	APPROVED:
As Shown	18.10.22	SG	SM	JD

JOB NO:	DRAWING NO:	REVISION:
2107-062	SK 101	-

Exact temporary junction  
design to be confirmed on site

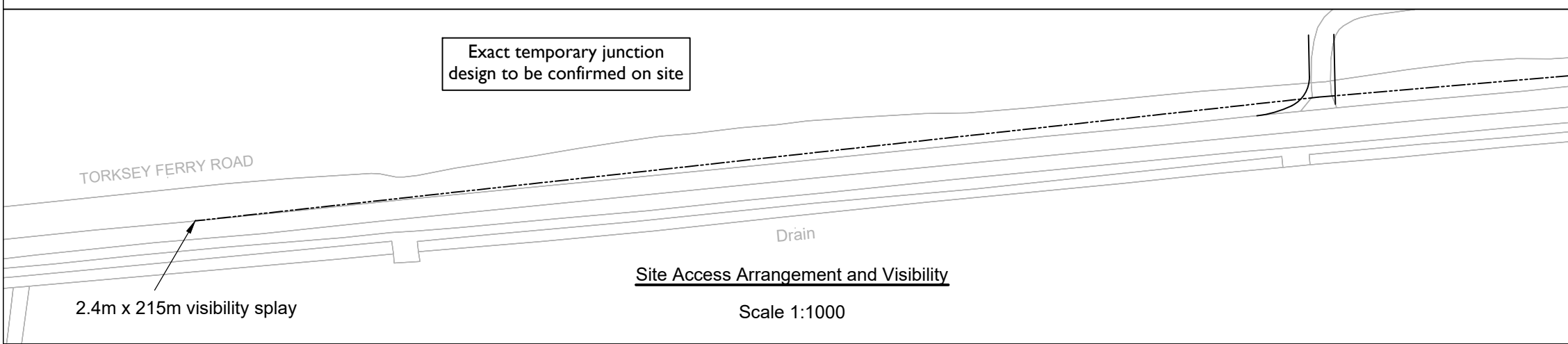

Site Access Arrangement and Visibility  
Scale 1:1000

2.4m x 215m visibility splay

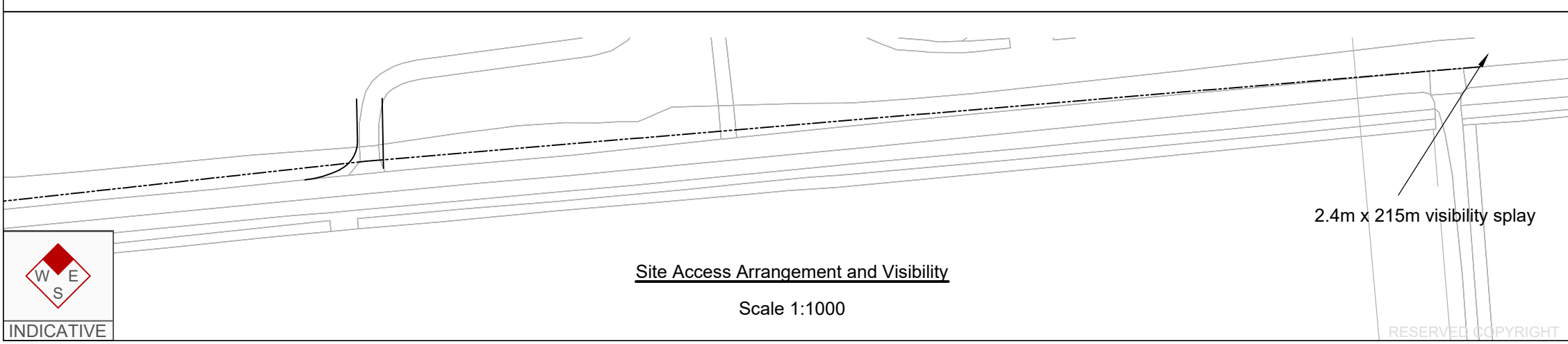

Site Access Arrangement and Visibility  
Scale 1:1000



RESERVED COPYRIGHT

A3

ORIGINAL PLOT SIZE

Banksman to assist accessing and egressing vehicles

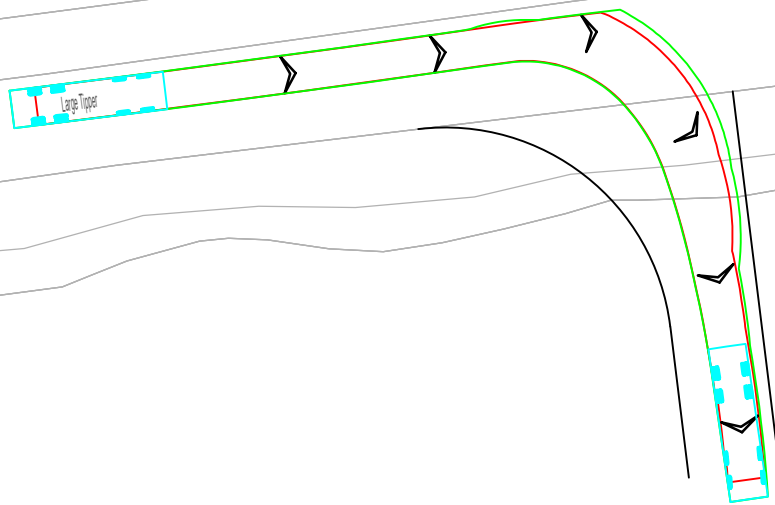

Tipper Vehicle Entering Site  
Scale 1:500

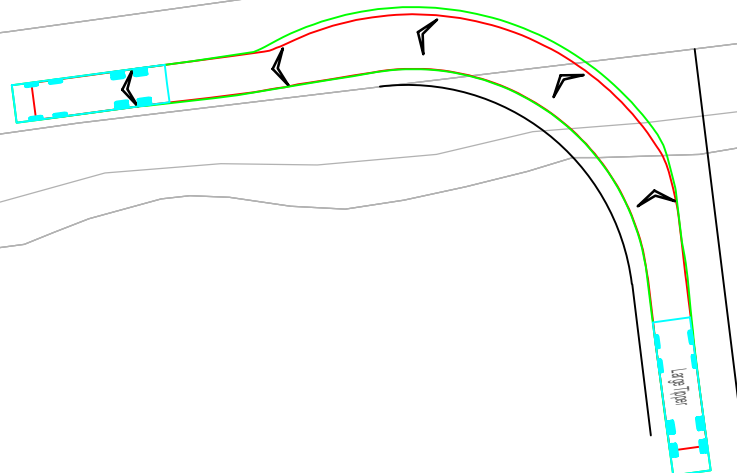

Tipper Vehicle Exiting Site  
Scale 1:500

Exact temporary junction design to be confirmed on site

2.4m x 215m visibility splay

Site Access Arrangement and Visibility  
Scale 1:1000

COTTAM ROAD  
2.4m x 215m visibility splay

Site Access Arrangement and Visibility  
Scale 1:1000



INDICATIVE

RESERVED COPYRIGHT

Reproduced from Ordnance Survey Superplan Data with the permission of The Controller of Her Majesty's Stationery Office. Crown Copyright - Licence No. AL100034021

NOTES:

1. The existing posted speed limit on Cottam Road is National Speed Limit (60mph)
2. OS base to be confirmed with topographical survey
3. Highway boundary to be confirmed

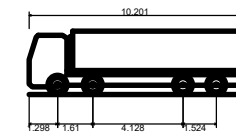

Large Tipper  
Overall Length 10.201m  
Overall Width 2.495m  
Overall Body Height 2.890m  
Min Body Ground Clearance 0.341m  
Track Width 2.471m  
Lock to lock time 6.00s  
Kerb to Kerb Turning Radius 11.550m

Rev	Date	Details	Drawn by	Checked by	Approved by
A	21.07.23	Access relocated to align with Gate Burton access location.	PSW	RR	JD

Bristol  
Cambridge  
London  
Manchester  
Oxford  
Welwyn Garden City



25 King Street  
Bristol  
BS1 4PB  
0117 925 9400  
[www.tpa.uk.com](http://www.tpa.uk.com)

CLIENT:  
**COTTAM SOLAR PROJECT LIMITED**

PROJECT:  
**COTTAM SOLAR FARM**

TITLE:  
**Cable Route Access Point 02**

STATUS:  
**INFORMATION**

SCALE: As Shown	DATE: 18.10.22	DRAWN: SG	CHECKED: SM	APPROVED: JD
JOB NO: 2107-062	DRAWING NO: SK 102	REVISION: A		

**A3**

ORIGINAL PLOT SIZE

Reproduced from Ordnance Survey Superplan Data with the permission of The Controller of Her Majesty's Stationary Office. Crown Copyright - Licence No. AL100034021

**NOTES:**

1. The existing posted speed limit on Cottam Road is National Speed Limit (60mph)
2. OS base to be confirmed with topographical survey
3. Highway boundary to be confirmed

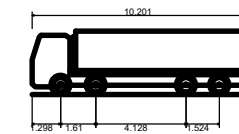

Large Tipper  
 Overall Length 10.201m  
 Overall Width 2.495m  
 Overall Body Height 2.890m  
 Min Body Ground Clearance 0.341m  
 Track Width 2.471m  
 Lock to lock time 6.00s  
 Kerb to Kerb Turning Radius 11.550m

Rev	Date	Details	Drawn by	Checked by	Approved by
A	21.07.23	Access relocated to align with Gate Burton access location.	PSW	RR	JD

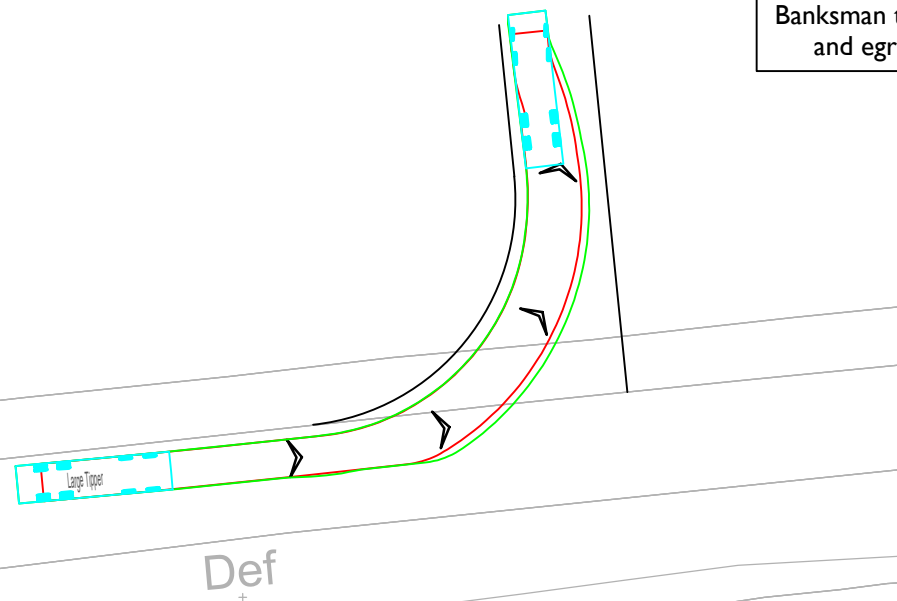

Tipper Vehicle Entering Site  
Scale 1:500

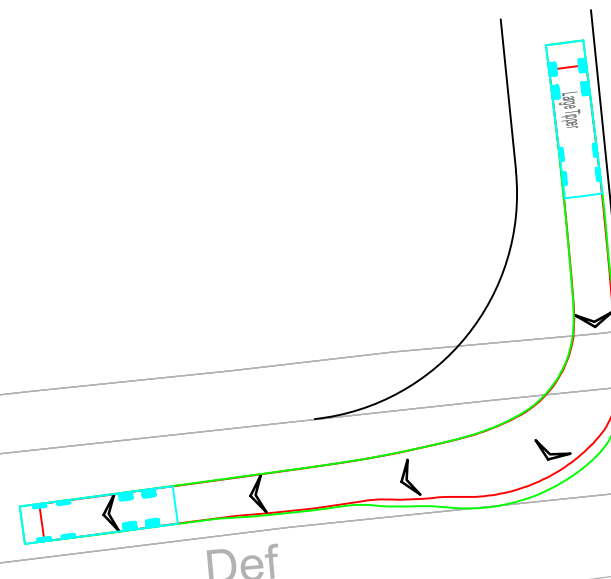

Tipper Vehicle Exiting Site  
Scale 1:500

Exact temporary junction design to be confirmed on site

2.4m x 215m visibility splay

6.4m

1.22m RH

Site Access Arrangement and Visibility

Scale 1:1000

CLIENT:

**COTTAM SOLAR PROJECT LIMITED**

PROJECT:

**COTTAM SOLAR FARM**

TITLE:

**Cable Route Access Point 03**

STATUS:

**INFORMATION**

SCALE: As Shown	DATE: 18.10.22	DRAWN: SG	CHECKED: SM	APPROVED: JD
JOB NO: 2107-062	DRAWING NO: SK 103	REVISION: A		



INDICATIVE

Site Access Arrangement and Visibility

Scale 1:1000

2.4m x 215m visibility splay

5.9m

COTTAM ROAD

1.22m RH

RESERVED COPYRIGHT



A3

ORIGINAL  
PLOT SIZE



INDICATIVE

2.4m x 137m visibility splay

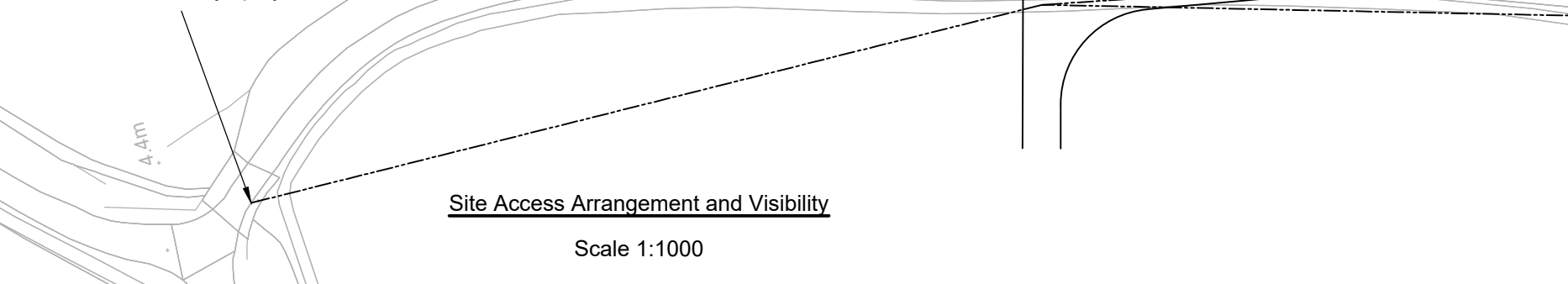

INDICATIVE

Exact temporary junction design to be confirmed on site

Site Access Arrangement and Visibility

Scale 1:1000

2.4m x tangential visibility splay

2.4m x 215m visibility splay



INDICATIVE

Reproduced from Ordnance Survey Superplan Data with the permission of The Controller of Her Majesty's Stationary Office. Crown Copyright - Licence No. AL100034021

NOTES:

1. The existing posted speed limit on Headstead Bank is National Speed Limit (60mph)
2. OS base to be confirmed with topographical survey
3. Highway boundary to be confirmed

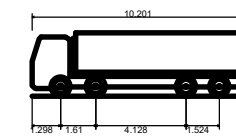

Large Tipper	10.201m
Overall Length	2.495m
Overall Width	2.890m
Overall Body Height	0.341m
Min Body Ground Clearance	2.471m
Track Width	6.00s
Lock to lock time	11.550m
Kerb to Kerb Turning Radius	

Rev	Date	Details	Drawn by	Checked by	Approved by
A	20.07.23	Access relocated to align with Gate Burton access location.	PSW	RR	JD

Bristol  
Cambridge  
London  
Manchester  
Oxford  
Welwyn Garden City



25 King Street  
Bristol  
BS1 4PB  
0117 925 9400  
[www.tpa.uk.com](http://www.tpa.uk.com)

CLIENT:  
**COTTAM SOLAR PROJECT LIMITED**

PROJECT:  
**COTTAM SOLAR FARM**

TITLE:  
**Cable Route Access Point 05**

STATUS:  
**INFORMATION**

SCALE:	DATE:	DRAWN:	CHECKED:	APPROVED:
As Shown	18.10.22	SG	SM	JD
JOB NO:	DRAWING NO:	REVISION:		
2107-062	SK 105	A		

RESERVED COPYRIGHT

**A3**  
ORIGINAL  
PLOT SIZE

Reproduced from Ordnance Survey Superplan Data with the permission of The Controller of Her Majesty's Stationery Office. Crown Copyright - Licence No. AL100034021

- NOTES:
1. The existing posted speed limit on Headstead Bank is National Speed Limit (60mph)
  2. OS base to be confirmed with topographical survey
  3. Highway boundary to be confirmed

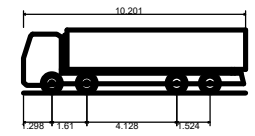

Large Tipper  
Overall Length 10.201m  
Overall Width 2.495m  
Overall Body Height 2.890m  
Min Body Ground Clearance 0.341m  
Track Width 2.471m  
Lock to lock time 6.00s  
Kerb to Kerb Turning Radius 11.550m

Rev	Date	Details	Drawn by	Checked by	Approved by
-	-	-	-	-	-

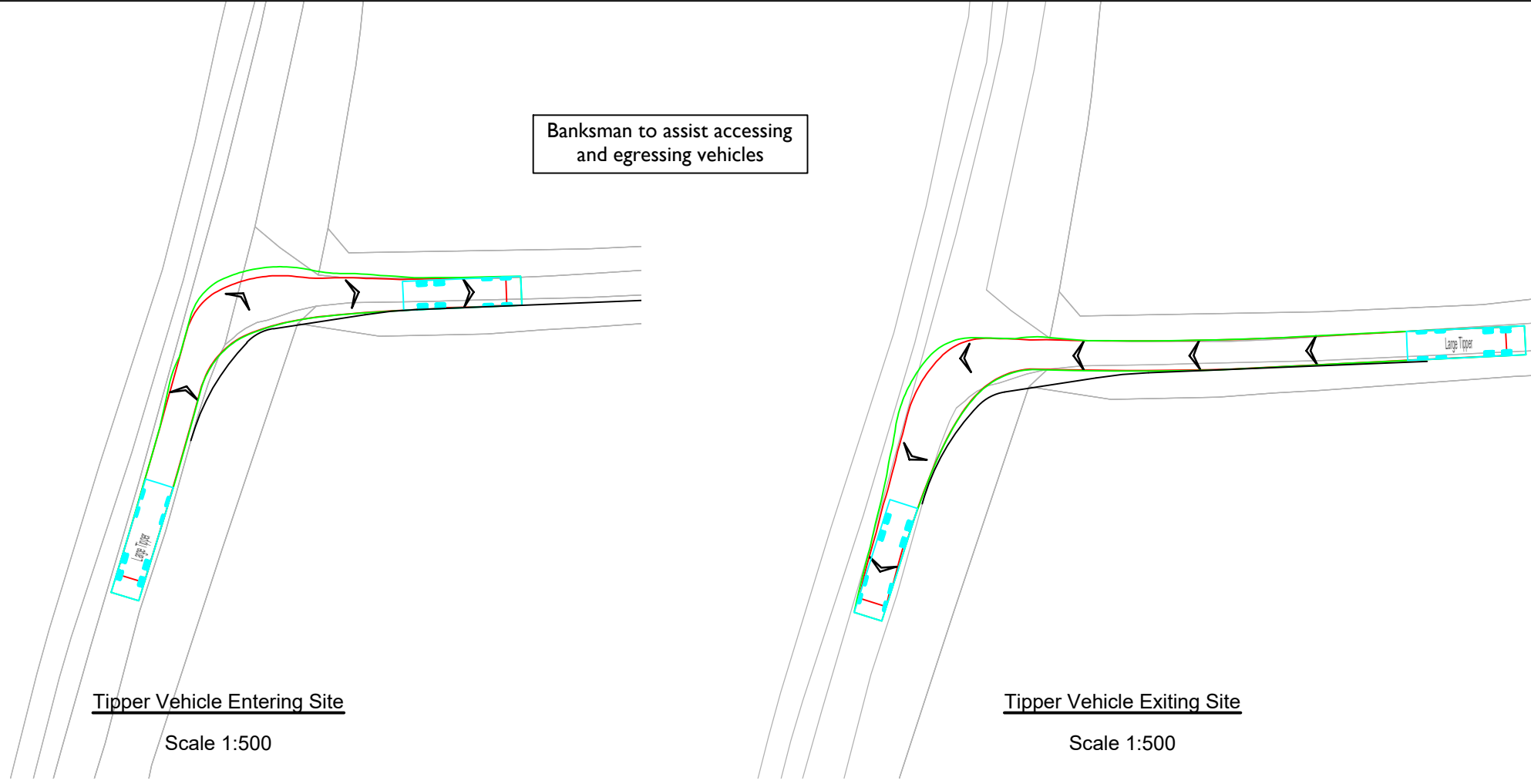

INDICATIVE

**Bristol**  
Cambridge  
London  
Manchester  
Oxford  
Welwyn Garden City

25 King Street  
Bristol  
BS1 4PB  
0117 925 9400  
[www.tpa.uk.com](http://www.tpa.uk.com)

CLIENT:  
**COTTAM SOLAR PROJECT LIMITED**

PROJECT:  
**COTTAM SOLAR FARM**

TITLE:  
**Cable Route Access Point 06**

STATUS:  
**INFORMATION**

SCALE: As Shown	DATE: 14.12.22	DRAWN: SG	CHECKED: SM	APPROVED: JD
--------------------	-------------------	--------------	----------------	-----------------

JOB NO: 2107-062	DRAWING NO: SK 106	REVISION: -
---------------------	-----------------------	----------------

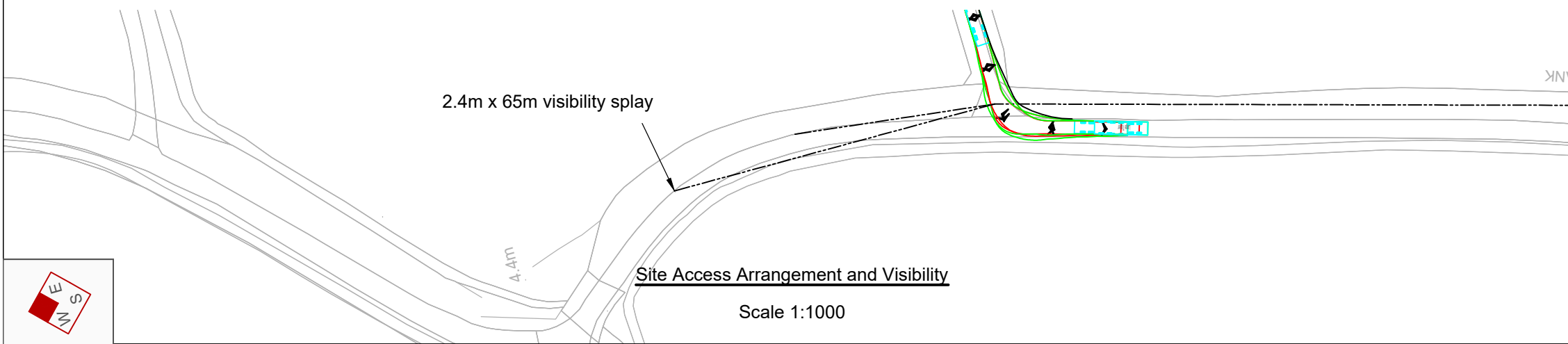

INDICATIVE

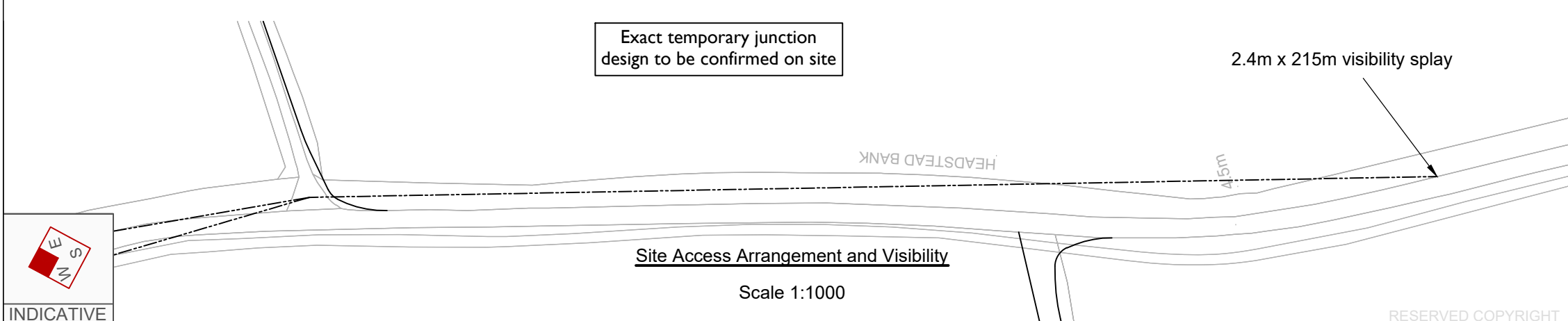

INDICATIVE

RESERVED COPYRIGHT

**A3**  
ORIGINAL  
PLOT SIZE

Reproduced from Ordnance Survey Superplan Data with the permission of The Controller of Her Majesty's Stationery Office. Crown Copyright - Licence No. AL100034021

- NOTES:
1. The existing posted speed limit on A156 is National Speed Limit (60mph)
  2. OS base to be confirmed with topographical survey
  3. Highway boundary to be confirmed

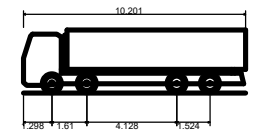

Large Tipper	10.201m
Overall Length	2.495m
Overall Width	2.890m
Overall Body Height	0.341m
Min Body Ground Clearance	2.471m
Track Width	6.00s
Lock to lock time	11.550m
Kerb to Kerb Turning Radius	

Rev	Date	Details	Drawn by	Checked by	Approved by
-	-	-	-	-	-



INDICATIVE

Tipper Vehicle Entering Site

Scale 1:500

Tipper Vehicle Exiting Site

Scale 1:500

Bristol  
Cambridge  
London  
Manchester  
Oxford  
Welwyn Garden City



25 King Street  
Bristol  
BS1 4PB  
0117 925 9400  
[www.tpa.uk.com](http://www.tpa.uk.com)

CLIENT:  
**COTTAM SOLAR PROJECT LIMITED**

PROJECT:  
**COTTAM SOLAR FARM**

TITLE:  
**Cable Route Access Point 07**

STATUS:  
**INFORMATION**

SCALE:	DATE:	DRAWN:	CHECKED:	APPROVED:
As Shown	18.10.22	SG	SM	JD

JOB NO:	DRAWING NO:	REVISION:
2107-062	SK 107	-

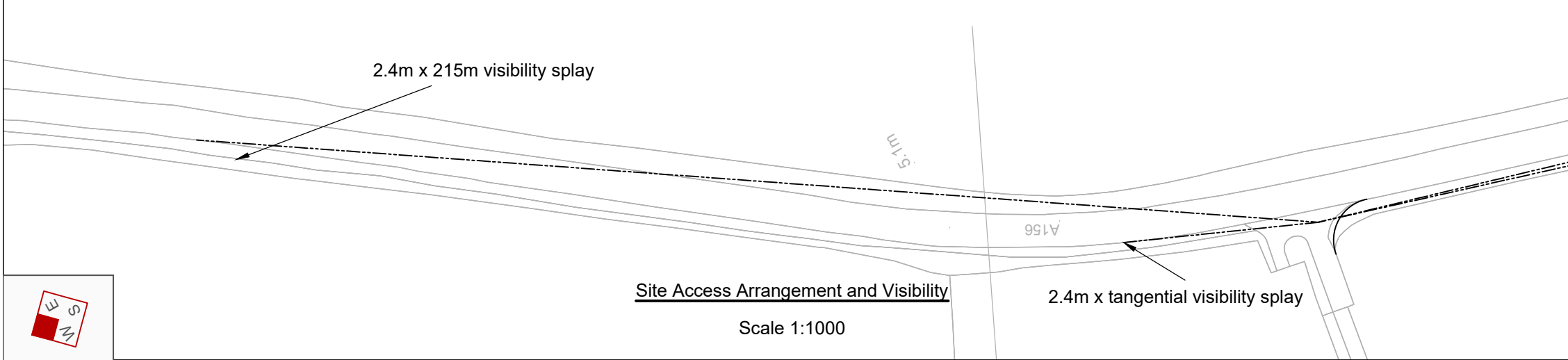

Site Access Arrangement and Visibility

Scale 1:1000



INDICATIVE

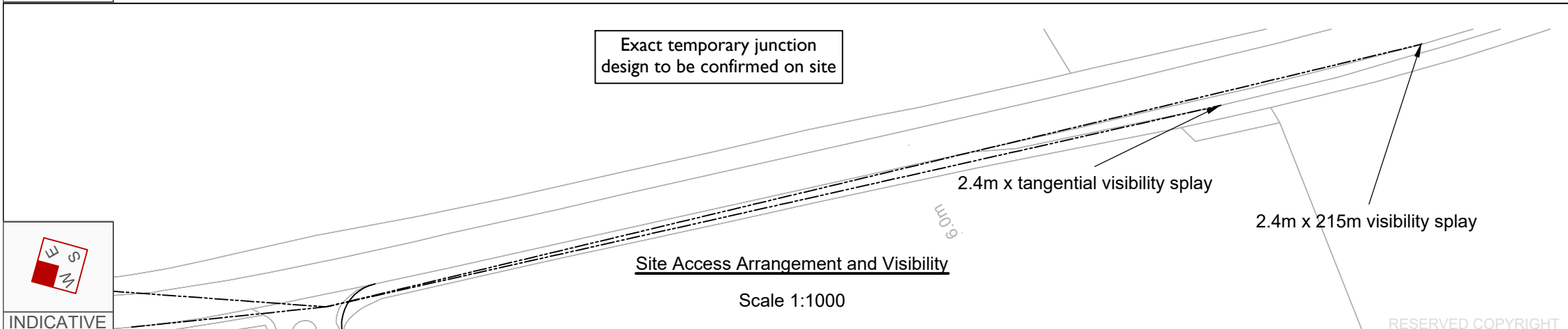

Site Access Arrangement and Visibility

Scale 1:1000



INDICATIVE

RESERVED COPYRIGHT

A3

ORIGINAL PLOT SIZE

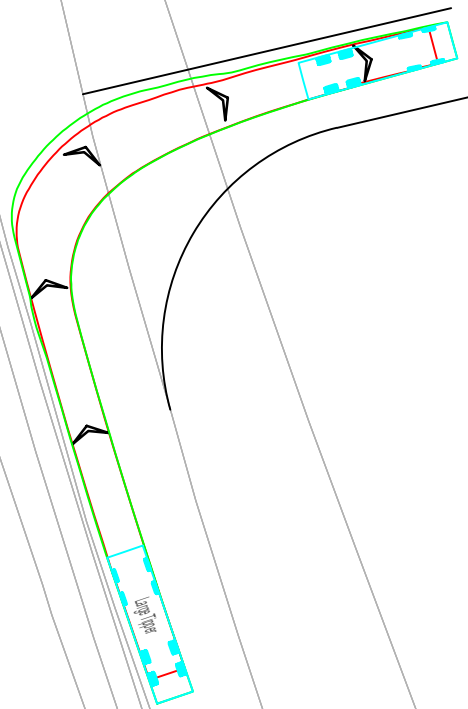

Tipper Vehicle Entering Site

Scale 1:500



Tipper Vehicle Exiting Site

Scale 1:500



INDICATIVE

2.4m x 215m visibility splay

Assumed Edge of Carriageway

Site Access Arrangement and Visibility

Scale 1:1000



INDICATIVE

Exact temporary junction design to be confirmed on site

HIGH STREET

Site Access Arrangement and Visibility

Scale 1:1000

2.4m x 215m visibility splay



INDICATIVE

Reproduced from Ordnance Survey Superplan Data with the permission of The Controller of Her Majesty's Stationery Office. Crown Copyright - Licence No. AL100034021

NOTES:

1. The existing posted speed limit on A156, High Street, is National Speed Limit (60mph)
2. OS base to be confirmed with topographical survey
3. Highway boundary to be confirmed

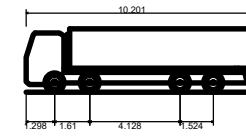

Large Tipper	10.201m
Overall Length	2.495m
Overall Width	2.890m
Overall Body Height	0.341m
Min Body Ground Clearance	2.471m
Track Width	6.00s
Lock to lock time	11.550m
Kerb to Kerb Turning Radius	

Rev	Date	Details	Drawn by	Checked by	Approved by
A	20.07.23	Access relocated to align with Gate Burton access location.	PSW	RR	JD

Bristol  
Cambridge  
London  
Manchester  
Oxford  
Welwyn Garden City



25 King Street  
Bristol  
BS1 4PB  
0117 925 9400  
[www.tpa.uk.com](http://www.tpa.uk.com)

CLIENT:  
**COTTAM SOLAR PROJECT LIMITED**

PROJECT:  
**COTTAM SOLAR FARM**

TITLE:  
**Cable Route Access Point 08**

STATUS:  
**INFORMATION**

SCALE:	DATE:	DRAWN:	CHECKED:	APPROVED:
As Shown	18.10.22	SG	SM	JD
JOB NO:	DRAWING NO:	REVISION:		
2107-062	SK 108	A		

RESERVED COPYRIGHT

A3

ORIGINAL PLOT SIZE

Reproduced from Ordnance Survey Superplan Data with the permission of The Controller of Her Majesty's Stationary Office. Crown Copyright - Licence No. AL100034021

NOTES:

- 1. The existing posted speed limit on Stow Park Road is National Speed Limit (60mph)
- 2. OS base to be confirmed with topographical survey
- 3. Highway boundary to be confirmed

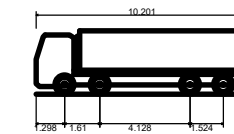

Large Tipper  
 Overall Length 10.201m  
 Overall Width 2.495m  
 Overall Body Height 2.890m  
 Min Body Ground Clearance 0.341m  
 Track Width 2.471m  
 Lock to lock time 6.00s  
 Kerb to Kerb Turning Radius 11.550m

Rev	Date	Details	Drawn by	Checked by	Approved by
A	20.07.23	Access relocated to align with Gate Burton access location.	PSW	RR	JD

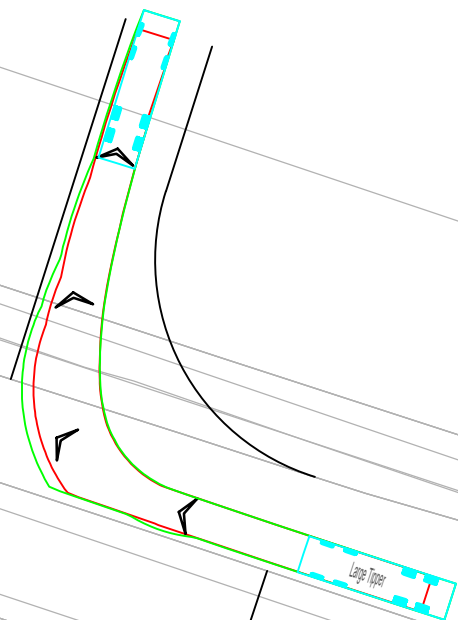

Tipper Vehicle Entering Site  
 Scale 1:500

Banksman to assist accessing and egressing vehicles

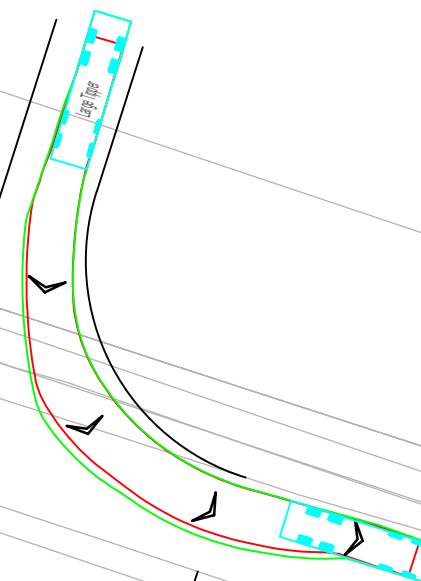

Tipper Vehicle Exiting Site  
 Scale 1:500



INDICATIVE

2.4m x 215m visibility splay

19.4m

Site Access Arrangement and Visibility

Scale 1:1000



INDICATIVE

Exact temporary junction design to be confirmed on site

14.4m

2.4m x 215m visibility splay

Site Access Arrangement and Visibility

Scale 1:1000



INDICATIVE

Bristol  
 Cambridge  
 London  
 Manchester  
 Oxford  
 Welwyn Garden City



25 King Street  
 Bristol  
 BS1 4PB  
 0117 925 9400  
[www.tpa.uk.com](http://www.tpa.uk.com)

CLIENT:  
**COTTAM SOLAR PROJECT LIMITED**

PROJECT:  
**COTTAM SOLAR FARM**

TITLE:  
**Cable Route Access Point 09**

STATUS:  
**INFORMATION**

SCALE: As Shown	DATE: 18.10.22	DRAWN: SG	CHECKED: SM	APPROVED: JD
JOB NO: 2107-062	DRAWING NO: SK 109	REVISION: A		

RESERVED COPYRIGHT

A3

ORIGINAL PLOT SIZE

Banksman to assist accessing and egressing vehicles

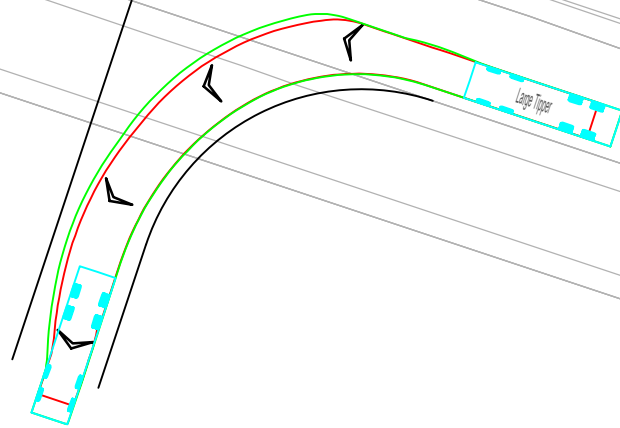

Tipper Vehicle Entering Site

Scale 1:500

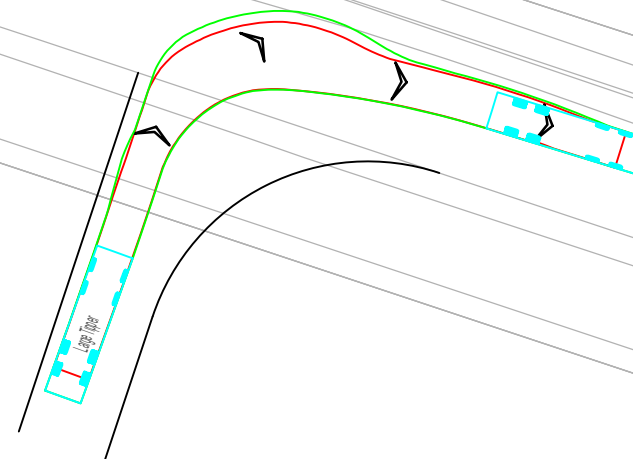

Tipper Vehicle Exiting Site

Scale 1:500



INDICATIVE

2.4m x 215m visibility splay

19.4m

Site Access Arrangement and Visibility

Scale 1:1000



INDICATIVE

Exact temporary junction design to be confirmed on site

14.4m

2.4m x 215m visibility splay

Site Access Arrangement and Visibility

Scale 1:1000



INDICATIVE

Reproduced from Ordnance Survey Superplan Data with the permission of The Controller of Her Majesty's Stationery Office. Crown Copyright - Licence No. AL100034021

NOTES:

- 1. The existing posted speed limit on Stow Park Road is National Speed Limit (60mph)
- 2. OS base to be confirmed with topographical survey
- 3. Highway boundary to be confirmed

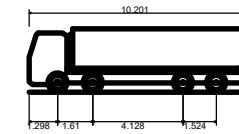

Large Tipper  
 Overall Length 10.201m  
 Overall Width 2.495m  
 Overall Body Height 2.890m  
 Min Body Ground Clearance 0.341m  
 Track Width 2.471m  
 Lock to lock time 6.00s  
 Kerb to Kerb Turning Radius 11.550m

Rev	Date	Details	Drawn by	Checked by	Approved by
A	20.07.23	Access relocated to align with Gate Burton access location.	PSW	RR	JD

Bristol  
 Cambridge  
 London  
 Manchester  
 Oxford  
 Welwyn Garden City



25 King Street  
 Bristol  
 BS1 4PB  
 0117 925 9400  
[www.tpa.uk.com](http://www.tpa.uk.com)

CLIENT: COTTAM SOLAR PROJECT LIMITED

PROJECT: COTTAM SOLAR FARM

TITLE: Cable Route Access Point 10

STATUS: INFORMATION

SCALE:	DATE:	DRAWN:	CHECKED:	APPROVED:
As Shown	18.10.22	SG	SM	JD
JOB NO:	DRAWING NO:	REVISION:		
2107-062	SK 110	A		

**A3**  
ORIGINAL  
PLOT SIZE

on Grange Barn



Tipper Vehicle Entering Site  
Scale 1:500



INDICATIVE

n Grange Barn

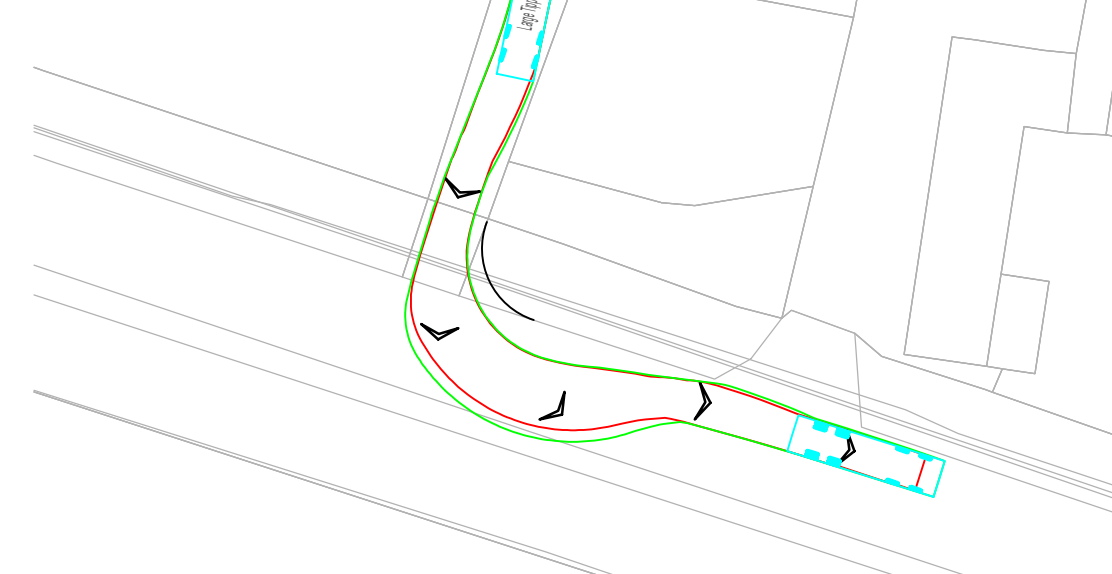

Tipper Vehicle Exiting Site  
Scale 1:500



INDICATIVE

Reproduced from Ordnance Survey Superplan Data with the permission of The Controller of Her Majesty's Stationery Office. Crown Copyright - Licence No. AL100034021

**NOTES:**

1. The existing posted speed limit on Stow Park Road is National Speed Limit (60mph)
2. OS base to be confirmed with topographical survey
3. Highway boundary to be confirmed

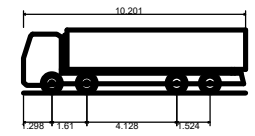

Large Tipper	10.201m
Overall Length	2.495m
Overall Width	2.890m
Overall Body Height	0.341m
Min Body Ground Clearance	2.471m
Track Width	6.00s
Lock to lock time	11.550m
Kerb to Kerb Turning Radius	

Rev	Date	Details	Drawn by	Checked by	Approved by
-	-	-	-	-	-

**Bristol**  
Cambridge  
London  
Manchester  
Oxford  
Welwyn Garden City

25 King Street  
Bristol  
BS1 4PB  
0117 925 9400  
[www.tpa.uk.com](http://www.tpa.uk.com)



CLIENT:  
**COTTAM SOLAR PROJECT LIMITED**

PROJECT:  
**COTTAM SOLAR FARM**

TITLE:  
**Cable Route Access Point 11**

STATUS:  
**INFORMATION**

SCALE:	DATE:	DRAWN:	CHECKED:	APPROVED:
As Shown	18.10.22	SG	SM	JD

JOB NO:	DRAWING NO:	REVISION:
2107-062	SK 111	-

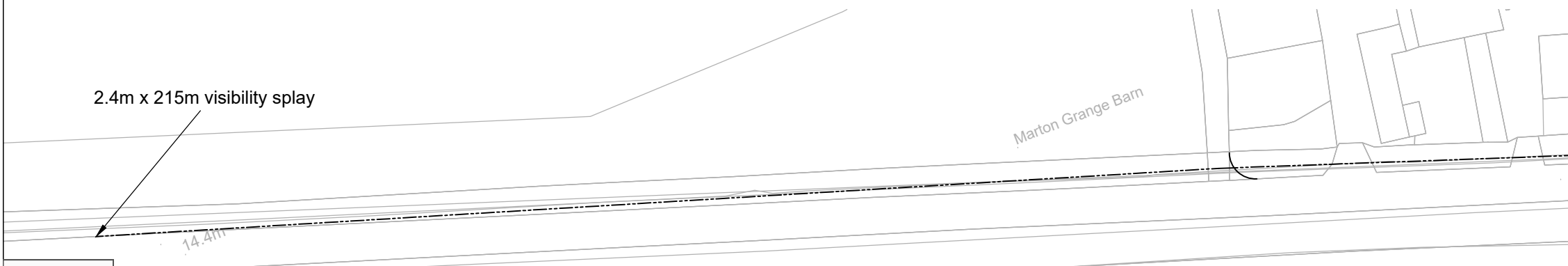

Site Access Arrangement and Visibility  
Scale 1:1000



INDICATIVE

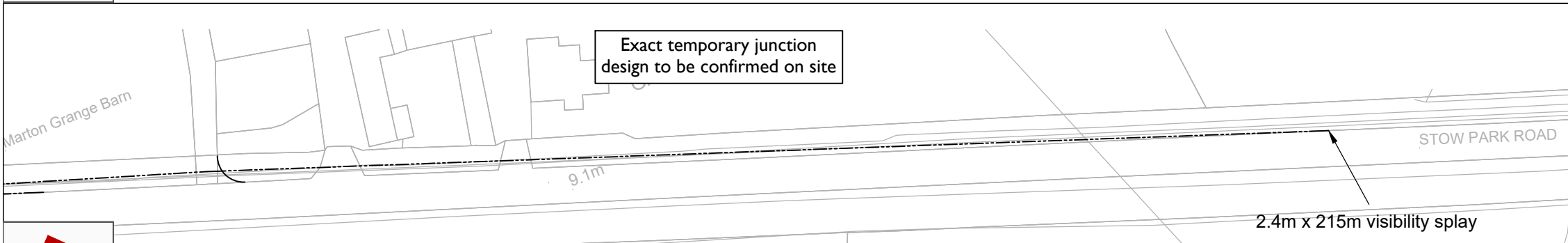

Site Access Arrangement and Visibility  
Scale 1:1000



INDICATIVE

RESERVED COPYRIGHT

**A3**  
ORIGINAL  
PLOT SIZE

Reproduced from Ordnance Survey Superplan Data with the permission of The Controller of Her Majesty's Stationery Office. Crown Copyright - Licence No. AL100034021

- NOTES:
1. The existing posted speed limit on Till Bridge Lane is National Speed Limit (60mph)
  2. OS base to be confirmed with topographical survey
  3. Highway boundary to be confirmed

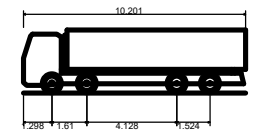

Large Tipper	10.201m
Overall Length	2.495m
Overall Width	2.890m
Overall Body Height	0.341m
Min Body Ground Clearance	2.471m
Track Width	6.00s
Lock to lock time	11.550m
Kerb to Kerb Turning Radius	

Rev	Date	Details	Drawn by	Checked by	Approved by
-	-	-	-	-	-



INDICATIVE

Tipper Vehicle Entering Site

Scale 1:500

Tipper Vehicle Exiting Site

Scale 1:500

**Bristol**  
Cambridge  
London  
Manchester  
Oxford  
Welwyn Garden City



25 King Street  
Bristol  
BS1 4PB  
0117 925 9400  
[www.tpa.uk.com](http://www.tpa.uk.com)

CLIENT:  
**COTTAM SOLAR PROJECT LIMITED**

PROJECT:  
**COTTAM SOLAR FARM**

TITLE:  
**Cable Route Access Point 12**

STATUS:  
**INFORMATION**

SCALE:	DATE:	DRAWN:	CHECKED:	APPROVED:
As Shown	18.10.22	SG	SM	JD

JOB NO:	DRAWING NO:	REVISION:
2107-062	SK 112	-

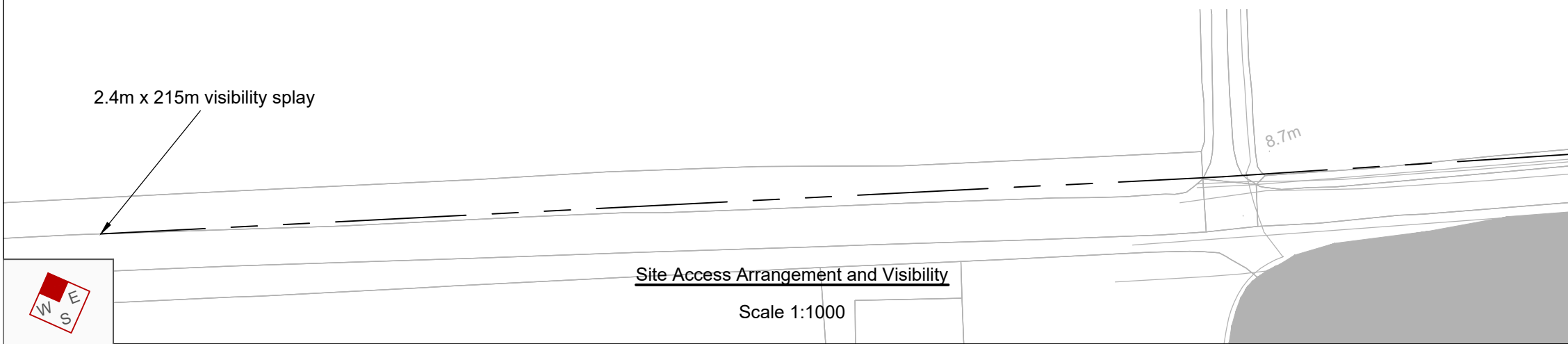

Site Access Arrangement and Visibility

Scale 1:1000

INDICATIVE

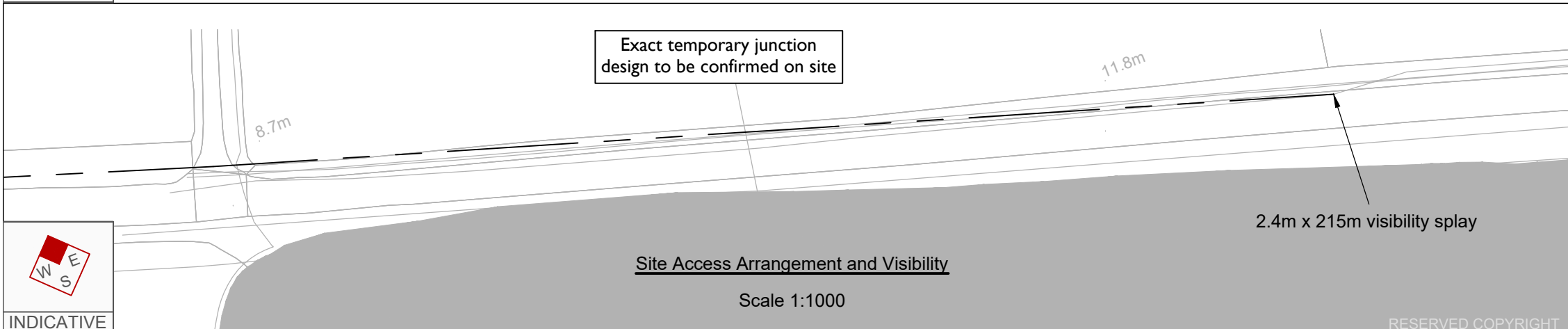

Site Access Arrangement and Visibility

Scale 1:1000

INDICATIVE

RESERVED COPYRIGHT



**A3**  
ORIGINAL  
PLOT SIZE

Reproduced from Ordnance Survey Superplan Data with the permission of The Controller of Her Majesty's Stationery Office. Crown Copyright - Licence No. AL100034021

- NOTES:
1. The existing posted speed limit on Stow Park Road is National Speed Limit (60mph)
  2. OS base to be confirmed with topographical survey
  3. Highway boundary to be confirmed

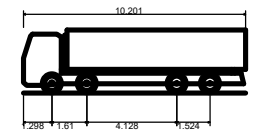

Large Tipper  
Overall Length 10.201m  
Overall Width 2.495m  
Overall Body Height 2.890m  
Min Body Ground Clearance 0.341m  
Track Width 2.471m  
Lock to lock time 6.00s  
Kerb to Kerb Turning Radius 11.550m

Rev	Date	Details	Drawn by	Checked by	Approved by
-	-	-	-	-	-

Banksman to assist accessing and egressing vehicles



Tipper Vehicle Entering Site  
Scale 1:500

Tipper Vehicle Exiting Site  
Scale 1:500

**Bristol**  
Cambridge  
London  
Manchester  
Oxford  
Welwyn Garden City

25 King Street  
Bristol  
BS1 4PB  
0117 925 9400  
[www.tpa.uk.com](http://www.tpa.uk.com)

CLIENT:  
**COTTAM SOLAR PROJECT LIMITED**

PROJECT:  
**COTTAM SOLAR FARM**

TITLE:  
**Cable Route Access Point 13**

STATUS:  
**INFORMATION**

SCALE: As Shown	DATE: 18.10.22	DRAWN: SG	CHECKED: SM	APPROVED: JD
JOB NO: 2107-062		DRAWING NO: SK 113		REVISION: -

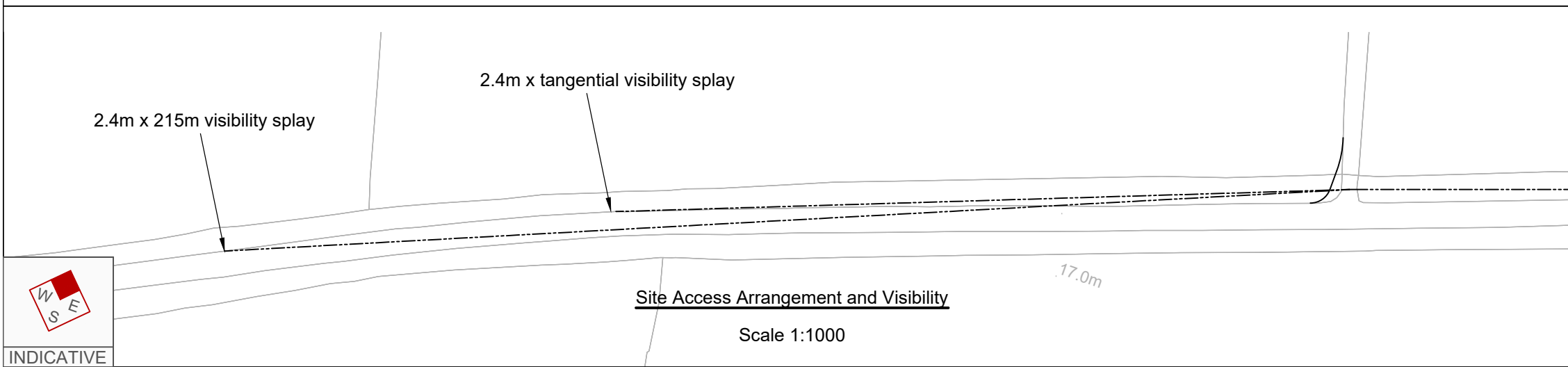

Site Access Arrangement and Visibility  
Scale 1:1000

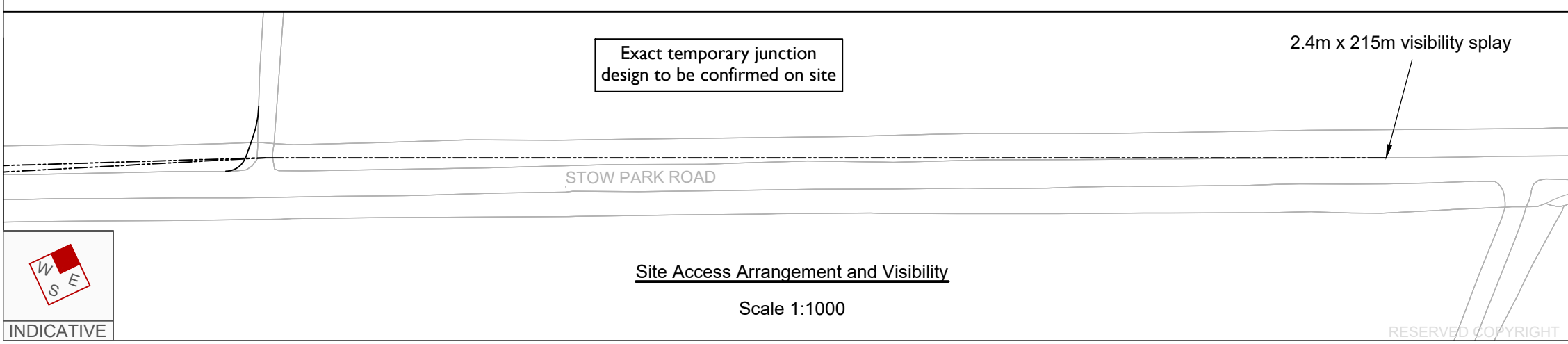

Site Access Arrangement and Visibility  
Scale 1:1000

RESERVED COPYRIGHT

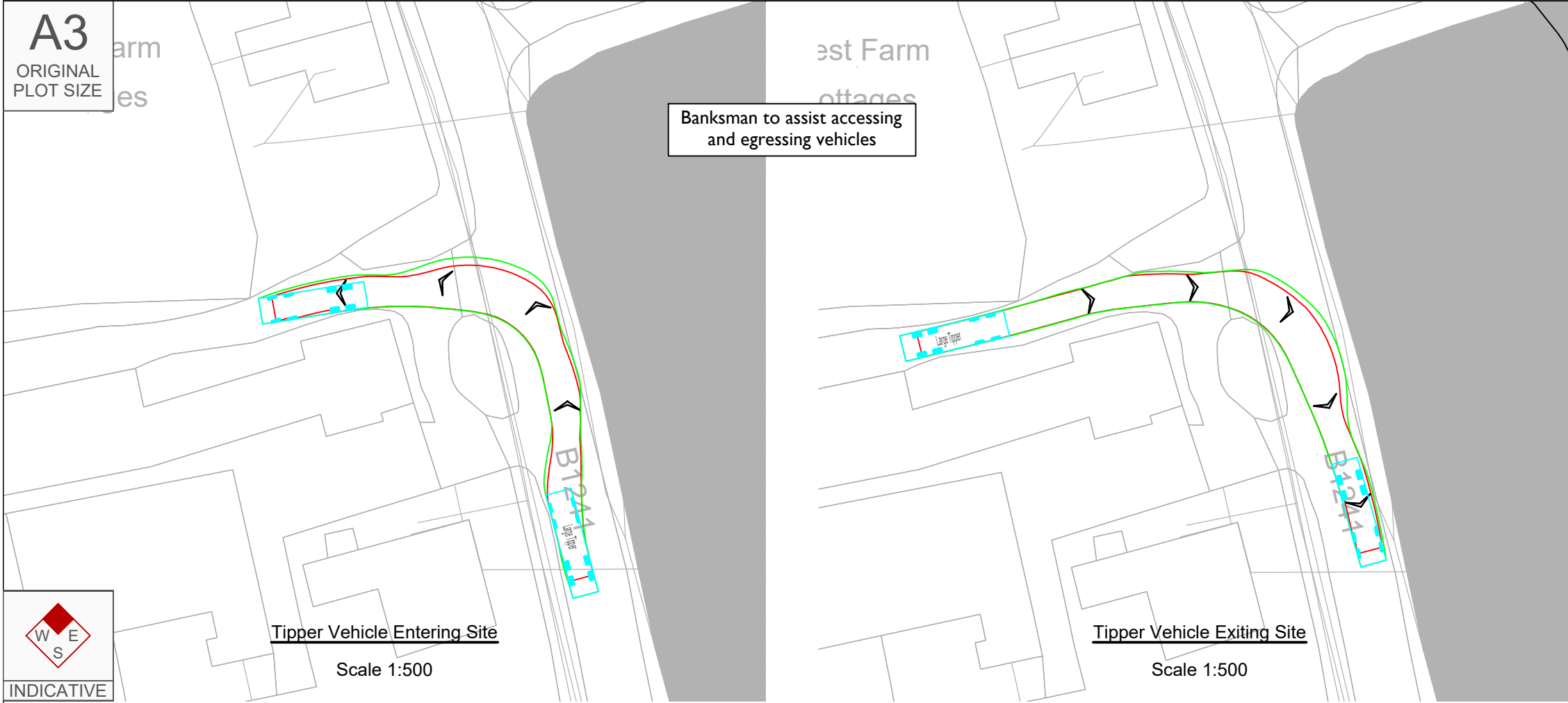

INDICATIVE

Reproduced from Ordnance Survey Superplan Data with the permission of The Controller of Her Majesty's Stationery Office. Crown Copyright - Licence No. AL100034021

- NOTES:
1. The existing posted speed limit on Normanby Road is National Speed Limit (60mph)
  2. OS base to be confirmed with topographical survey
  3. Highway boundary to be confirmed

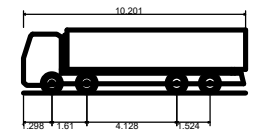

Large Tipper  
 Overall Length 10.201m  
 Overall Width 2.495m  
 Overall Body Height 2.890m  
 Min Body Ground Clearance 0.341m  
 Track Width 2.471m  
 Lock to lock time 6.00s  
 Kerb to Kerb Turning Radius 11.550m

Rev	Date	Details	Drawn by	Checked by	Approved by
-	-	-	-	-	-

**Bristol**  
 Cambridge  
 London  
 Manchester  
 Oxford  
 Welwyn Garden City

25 King Street  
 Bristol  
 BS1 4PB  
 0117 925 9400  
[www.tpa.uk.com](http://www.tpa.uk.com)



CLIENT:  
**COTTAM SOLAR PROJECT LIMITED**

PROJECT:  
**COTTAM SOLAR FARM**

TITLE:  
**Cable Route Access Point 14**

STATUS:  
**INFORMATION**

SCALE: As Shown	DATE: 14.12.22	DRAWN: SG	CHECKED: SM	APPROVED: JD
--------------------	-------------------	--------------	----------------	-----------------

JOB NO: 2107-062	DRAWING NO: SK 114	REVISION: -
---------------------	-----------------------	----------------

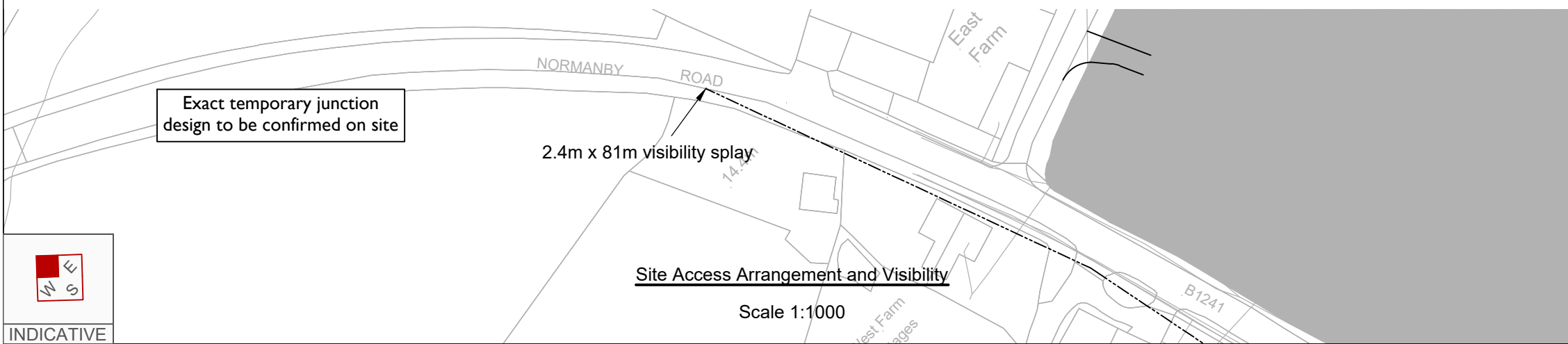

INDICATIVE

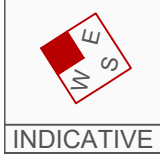
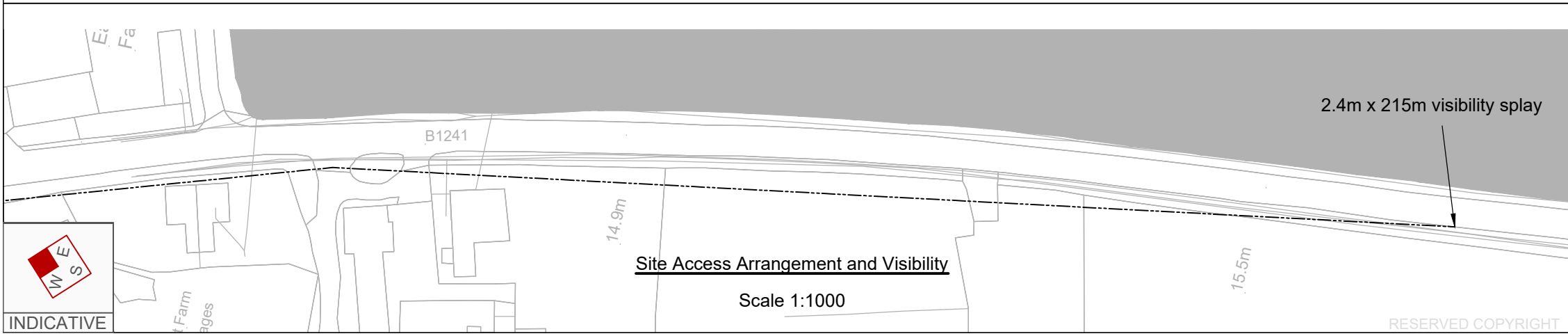

INDICATIVE

RESERVED COPYRIGHT

**A3**  
ORIGINAL  
PLOT SIZE



Reproduced from Ordnance Survey Superplan Data with the permission of The Controller of Her Majesty's Stationery Office. Crown Copyright - Licence No. AL100034021

- NOTES:
1. The existing posted speed limit on Normanby Road is National Speed Limit (60mph)
  2. OS base to be confirmed with topographical survey
  3. Highway boundary to be confirmed

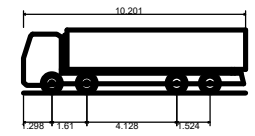

Large Tipper  
Overall Length 10.201m  
Overall Width 2.495m  
Overall Body Height 2.890m  
Min Body Ground Clearance 0.341m  
Track Width 2.471m  
Lock to lock time 6.00s  
Kerb to Kerb Turning Radius 11.550m

Rev	Date	Details	Drawn by	Checked by	Approved by
-	-	-	-	-	-

**Bristol**  
Cambridge  
London  
Manchester  
Oxford  
Welwyn Garden City

25 King Street  
Bristol  
BS1 4PB  
0117 925 9400  
[www.tpa.uk.com](http://www.tpa.uk.com)

CLIENT:  
**COTTAM SOLAR PROJECT LIMITED**

PROJECT:  
**COTTAM SOLAR FARM**

TITLE:  
**Cable Route Access Point 15**

STATUS:  
**INFORMATION**

SCALE: As Shown	DATE: 18.10.22	DRAWN: SG	CHECKED: SM	APPROVED: JD
JOB NO: 2107-062		DRAWING NO: SK 115		REVISION: -

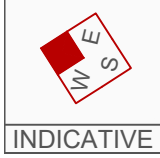
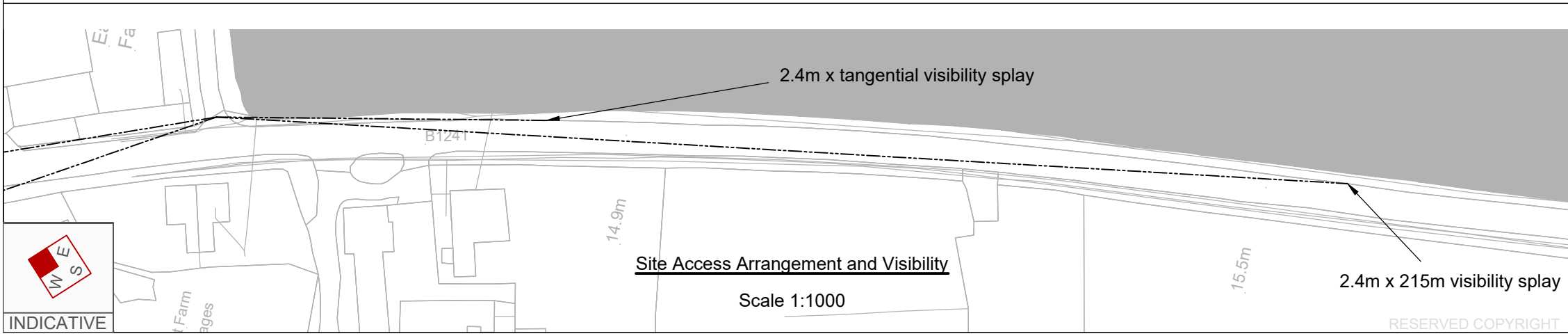
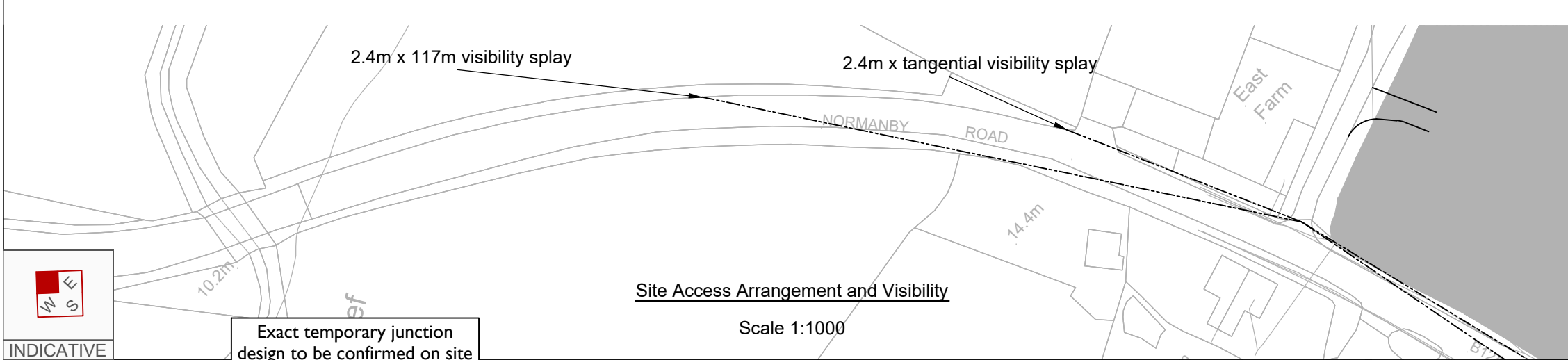

RESERVED COPYRIGHT

**A3**  
ORIGINAL  
PLOT SIZE

Reproduced from Ordnance Survey Superplan Data with the permission of The Controller of Her Majesty's Stationery Office. Crown Copyright - Licence No. AL100034021

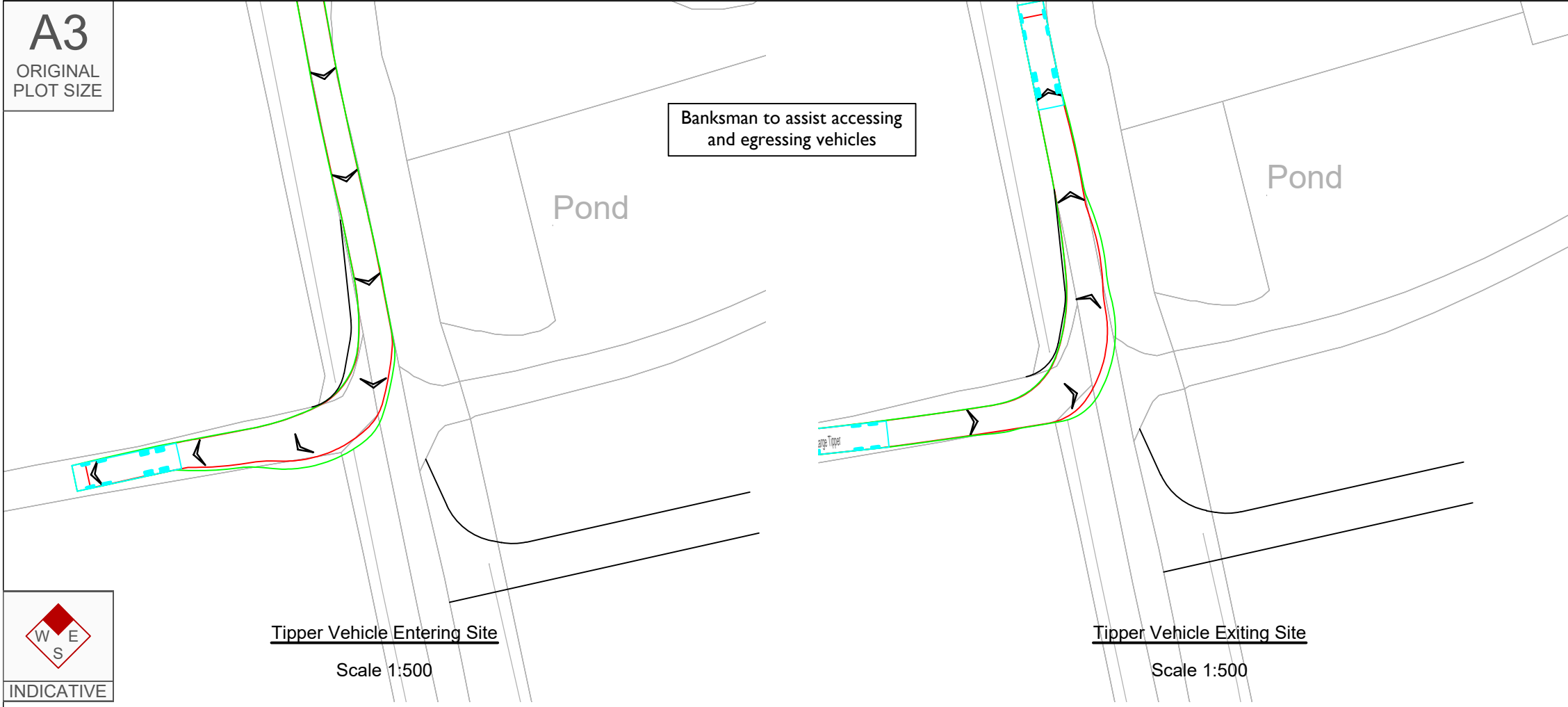

- NOTES:**
1. The existing posted speed limit on South Lane is National Speed Limit (60mph)
  2. OS base to be confirmed with topographical survey
  3. Highway boundary to be confirmed

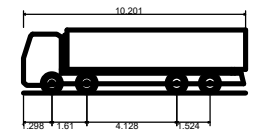

Large Tipper	10.201m
Overall Length	2.495m
Overall Width	2.890m
Overall Body Height	0.341m
Min Body Ground Clearance	2.471m
Track Width	6.00s
Lock to lock time	11.550m
Kerb to Kerb Turning Radius	

Rev	Date	Details	Drawn by	Checked by	Approved by
-	-	-	-	-	-



Tipper Vehicle Entering Site  
Scale 1:500

Tipper Vehicle Exiting Site  
Scale 1:500

**Bristol**  
Cambridge  
London  
Manchester  
Oxford  
Welwyn Garden City



25 King Street  
Bristol  
BS1 4PB  
0117 925 9400  
[www.tpa.uk.com](http://www.tpa.uk.com)

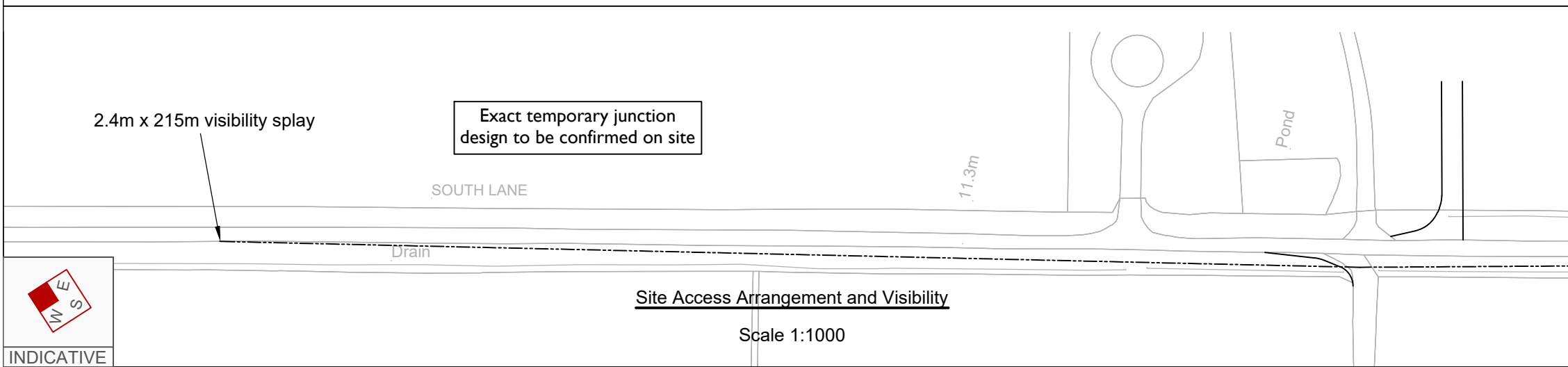

CLIENT:  
**COTTAM SOLAR PROJECT LIMITED**

PROJECT:  
**COTTAM SOLAR FARM**



Site Access Arrangement and Visibility  
Scale 1:1000

TITLE:  
**Cable Route Access Point 16**

STATUS:  
**INFORMATION**

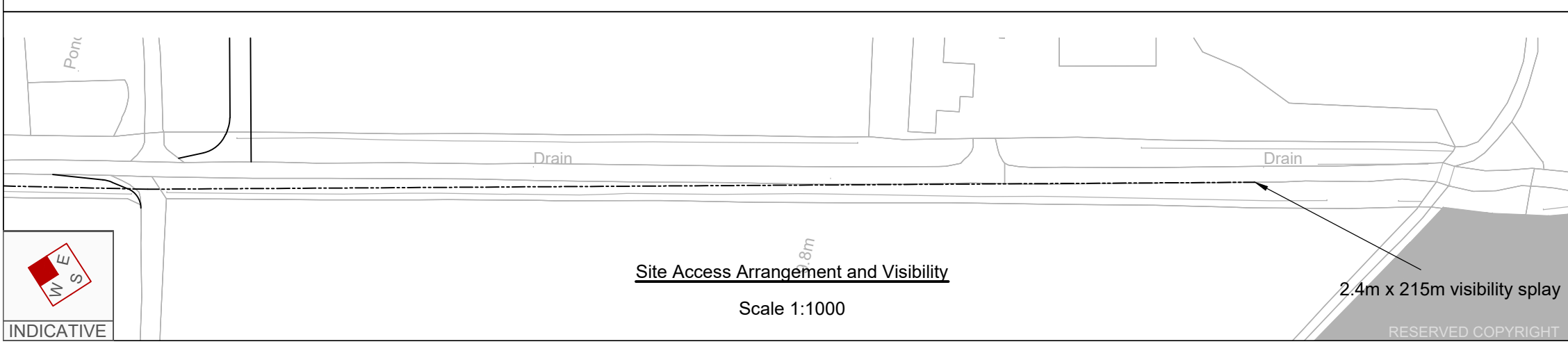

Site Access Arrangement and Visibility  
Scale 1:1000

SCALE: As Shown	DATE: 18.10.22	DRAWN: SG	CHECKED: SM	APPROVED: JD
JOB NO: 2107-062	DRAWING NO: SK 116	REVISION: -		

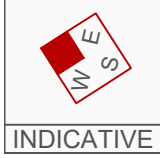

RESERVED COPYRIGHT

**A3**  
ORIGINAL  
PLOT SIZE

Reproduced from Ordnance Survey Superplan Data with the permission of The Controller of Her Majesty's Stationery Office. Crown Copyright - Licence No. AL100034021



INDICATIVE



- NOTES:
1. The existing posted speed limit on South Lane is National Speed Limit (60mph)
  2. OS base to be confirmed with topographical survey
  3. Highway boundary to be confirmed

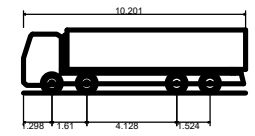

Large Tipper	10.201m
Overall Length	2.495m
Overall Width	2.890m
Overall Body Height	0.341m
Min Body Ground Clearance	2.471m
Track Width	6.00s
Lock to lock time	11.550m
Kerb to Kerb Turning Radius	

Rev	Date	Details	Drawn by	Checked by	Approved by
-	-	-	-	-	-

**Bristol**  
Cambridge  
London  
Manchester  
Oxford  
Welwyn Garden City

25 King Street  
Bristol  
BS1 4PB  
0117 925 9400  
[www.tpa.uk.com](http://www.tpa.uk.com)

CLIENT:  
**COTTAM SOLAR PROJECT LIMITED**

PROJECT:  
**COTTAM SOLAR FARM**

TITLE:  
**Cable Route Access Point 17**

STATUS:  
**INFORMATION**

SCALE: As Shown	DATE: 18.10.22	DRAWN: SG	CHECKED: SM	APPROVED: JD
JOB NO: 2107-062		DRAWING NO: SK 117		REVISION: -

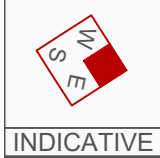

INDICATIVE

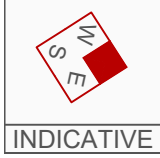
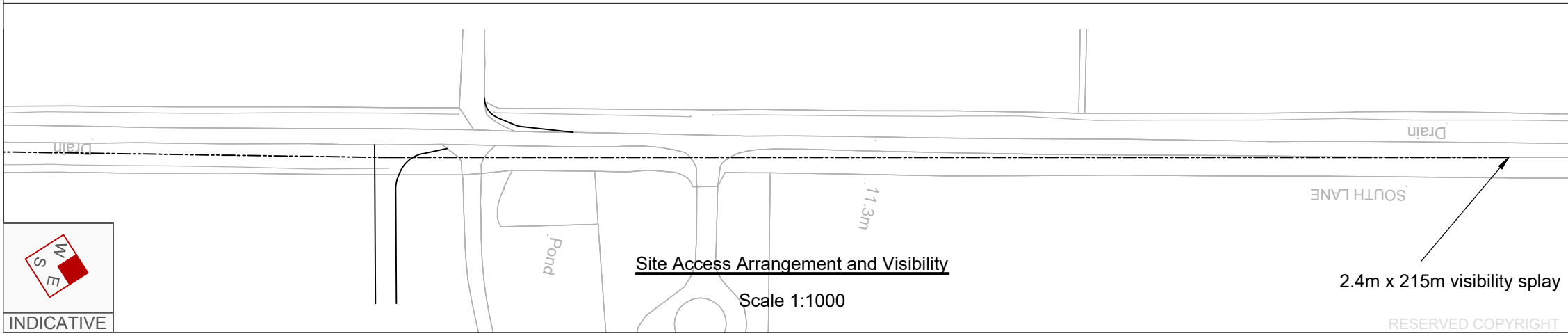

INDICATIVE

RESERVED COPYRIGHT

**A3**  
ORIGINAL  
PLOT SIZE

Reproduced from Ordnance Survey Superplan Data with the permission of The Controller of Her Majesty's Stationery Office. Crown Copyright - Licence No. AL100034021

- NOTES:
1. The existing posted speed limit on Fillingham Lane is National Speed Limit (60mph)
  2. OS base to be confirmed with topographical survey
  3. Highway boundary to be confirmed

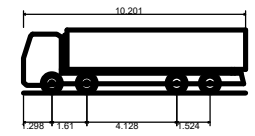

Large Tipper	10.201m
Overall Length	2.495m
Overall Width	2.890m
Overall Body Height	0.341m
Min Body Ground Clearance	2.471m
Track Width	6.00s
Lock to lock time	11.550m
Kerb to Kerb Turning Radius	

Rev	Date	Details	Drawn by	Checked by	Approved by
-	-	-	-	-	-

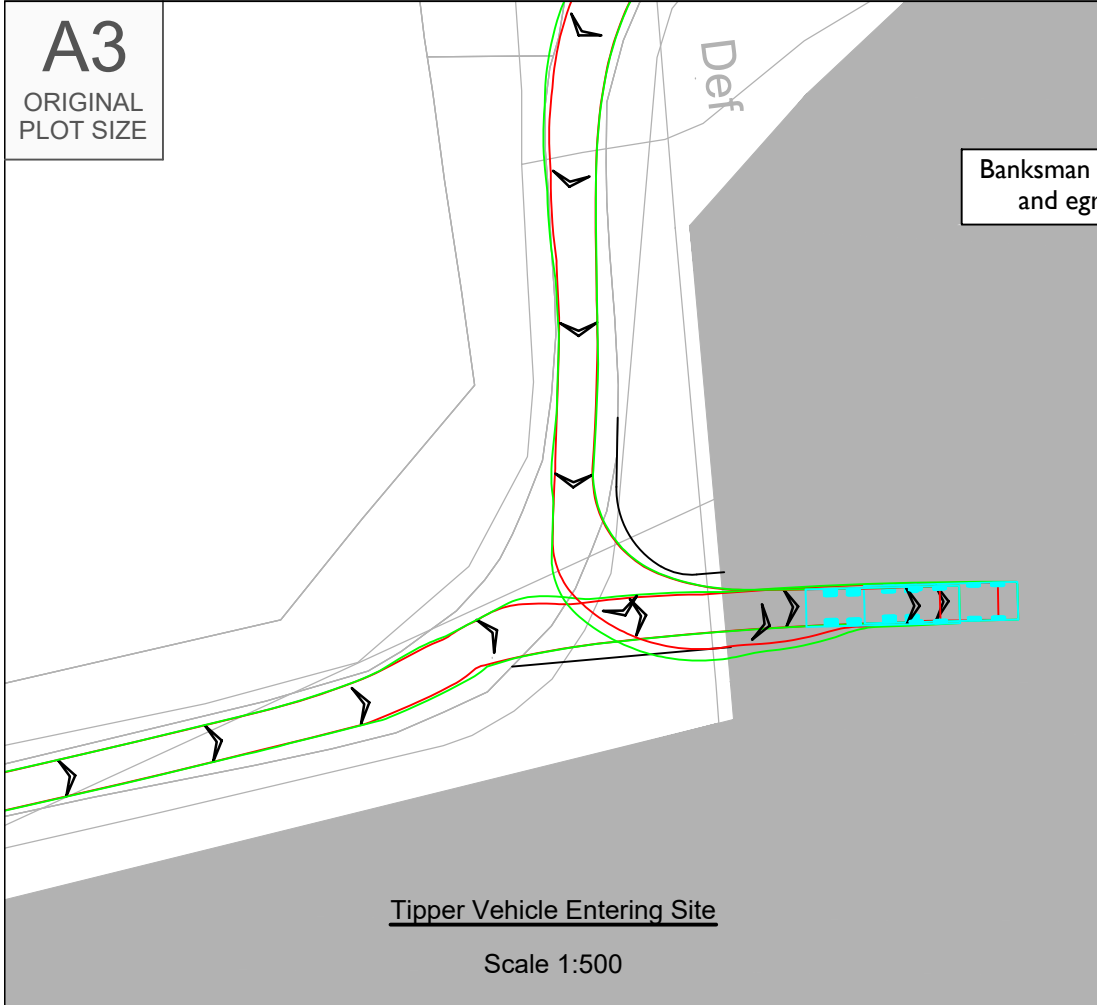

Tipper Vehicle Entering Site  
Scale 1:500

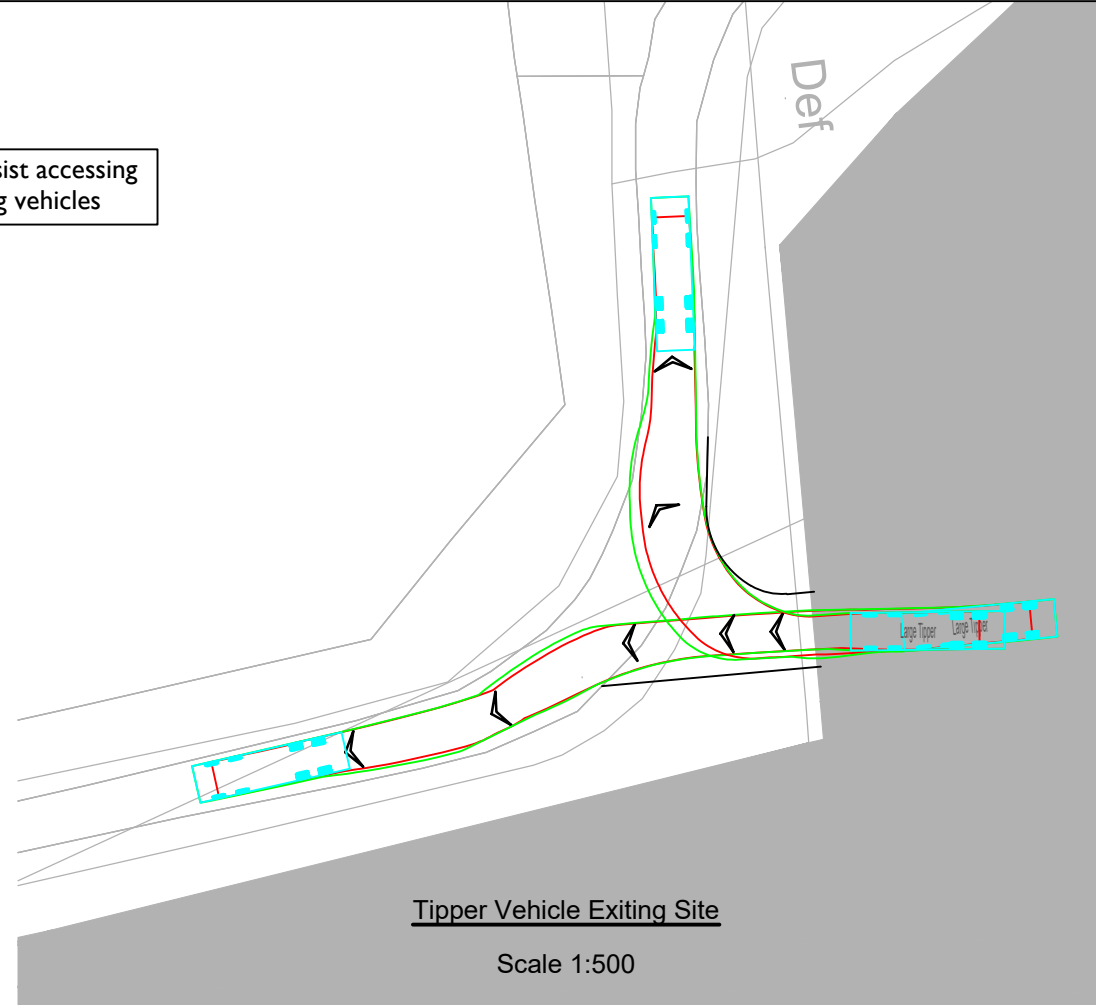

Tipper Vehicle Exiting Site  
Scale 1:500

**Bristol**  
Cambridge  
London  
Manchester  
Oxford  
Welwyn Garden City

25 King Street  
Bristol  
BS1 4PB  
0117 925 9400  
[www.tpa.uk.com](http://www.tpa.uk.com)



CLIENT:  
**COTTAM SOLAR PROJECT LIMITED**

PROJECT:  
**COTTAM SOLAR FARM**

TITLE:  
**Cable Route Access Point 18**

STATUS:  
**INFORMATION**

SCALE: As Shown	DATE: 14.12.22	DRAWN: SG	CHECKED: SM	APPROVED: JD
JOB NO: 2107-062	DRAWING NO: SK 118	REVISION: -		

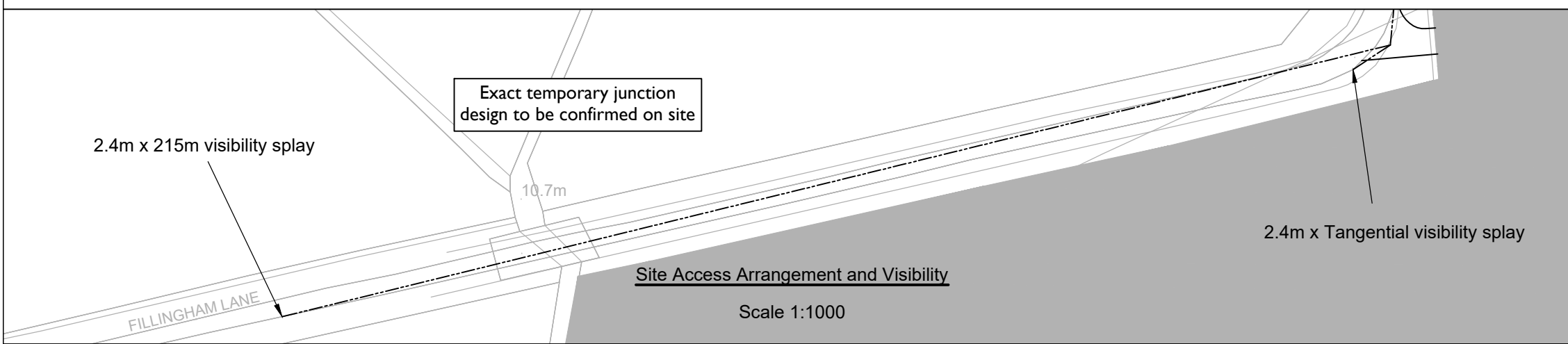

Site Access Arrangement and Visibility  
Scale 1:1000

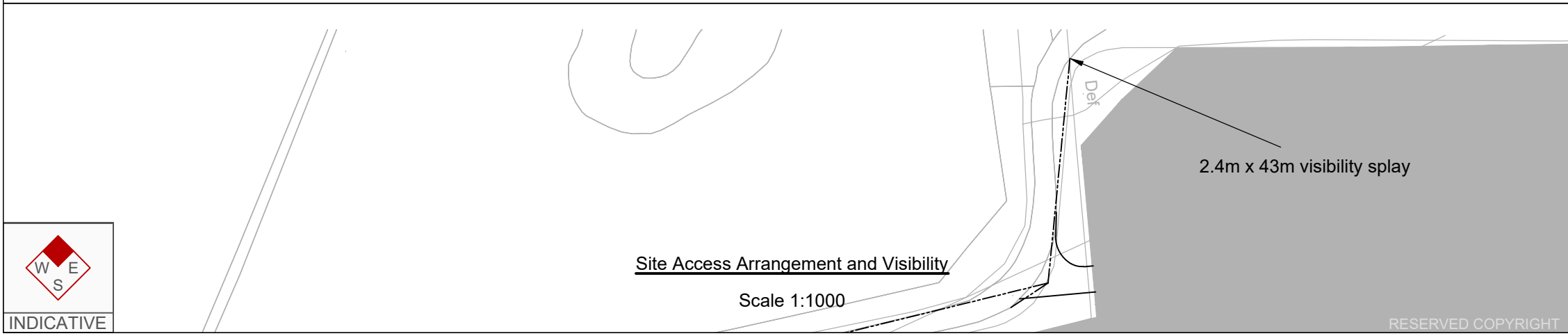

Site Access Arrangement and Visibility  
Scale 1:1000



RESERVED COPYRIGHT

**A3**  
ORIGINAL  
PLOT SIZE

Reproduced from Ordnance Survey Superplan Data with the permission of The Controller of Her Majesty's Stationery Office. Crown Copyright - Licence No. AL100034021

- NOTES:
1. The existing posted speed limit on Glentworth Road is National Speed Limit (60mph)
  2. OS base to be confirmed with topographical survey
  3. Highway boundary to be confirmed

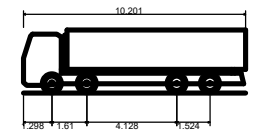

Large Tipper	10.201m
Overall Length	2.495m
Overall Width	2.890m
Overall Body Height	0.341m
Min Body Ground Clearance	2.471m
Track Width	6.00s
Lock to lock time	11.550m
Kerb to Kerb Turning Radius	

Rev	Date	Details	Drawn by	Checked by	Approved by
-	-	-	-	-	-



Tipper Vehicle Entering Site  
Scale 1:500

Tipper Vehicle Exiting Site  
Scale 1:500

Banksman to assist accessing and egressing vehicles

**Bristol**  
Cambridge  
London  
Manchester  
Oxford  
Welwyn Garden City

25 King Street  
Bristol  
BS1 4PB  
0117 925 9400  
[www.tpa.uk.com](http://www.tpa.uk.com)



CLIENT:  
**COTTAM SOLAR PROJECT LIMITED**

PROJECT:  
**COTTAM SOLAR FARM**

TITLE:  
**Cable Route Access Point 19**

STATUS:  
**INFORMATION**

SCALE: As Shown	DATE: 18.10.22	DRAWN: SG	CHECKED: SM	APPROVED: JD
--------------------	-------------------	--------------	----------------	-----------------

JOB NO: 2107-062	DRAWING NO: SK 119	REVISION: -
---------------------	-----------------------	----------------

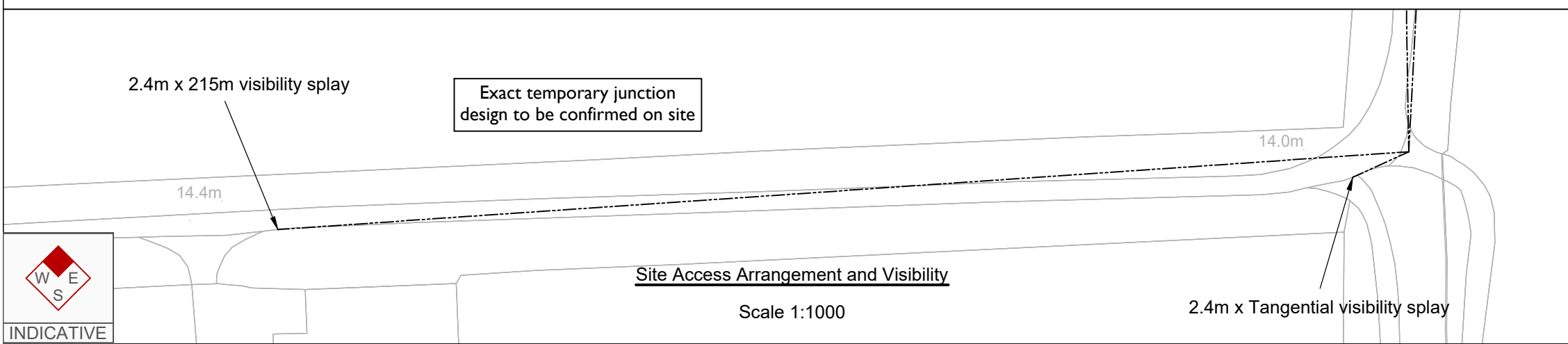

Site Access Arrangement and Visibility  
Scale 1:1000

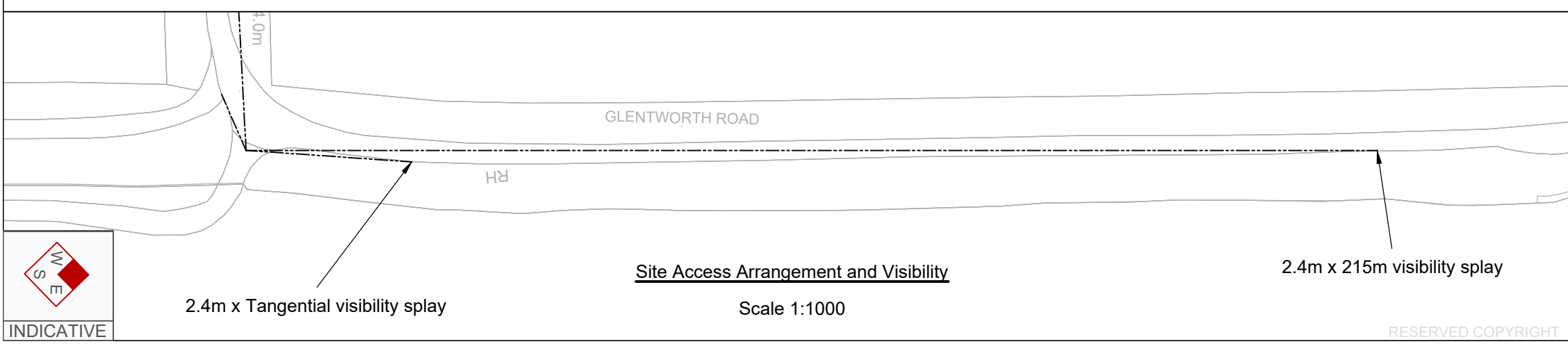

Site Access Arrangement and Visibility  
Scale 1:1000

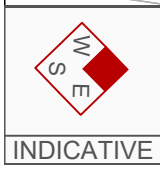

RESERVED COPYRIGHT

**A3**  
ORIGINAL  
PLOT SIZE

Reproduced from Ordnance Survey Superplan Data with the permission of The Controller of Her Majesty's Stationery Office. Crown Copyright - Licence No. AL100034021

- NOTES:
1. The existing posted speed limit on Kexby Road is National Speed Limit (60mph)
  2. OS base to be confirmed with topographical survey
  3. Highway boundary to be confirmed

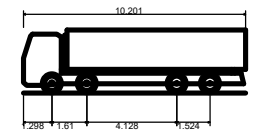

Large Tipper  
Overall Length 10.201m  
Overall Width 2.495m  
Overall Body Height 2.890m  
Min Body Ground Clearance 0.341m  
Track Width 2.471m  
Lock to lock time 6.00s  
Kerb to Kerb Turning Radius 11.550m

Rev	Date	Details	Drawn by	Checked by	Approved by
-	-	-	-	-	-

Banksman to assist accessing and egressing vehicles



Tipper Vehicle Entering Site  
Scale 1:500

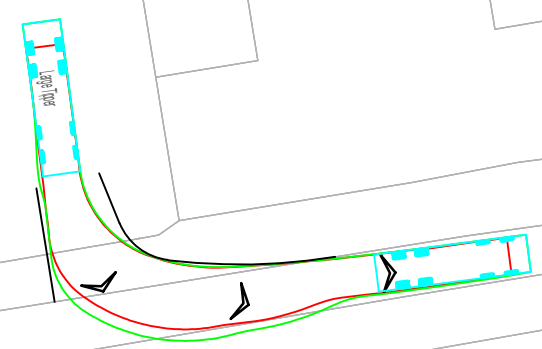

Tipper Vehicle Exiting Site  
Scale 1:500

**Bristol**  
Cambridge  
London  
Manchester  
Oxford  
Welwyn Garden City

25 King Street  
Bristol  
BS1 4PB  
0117 925 9400  
[www.tpa.uk.com](http://www.tpa.uk.com)



CLIENT:  
**COTTAM SOLAR PROJECT LIMITED**

PROJECT:  
**COTTAM SOLAR FARM**

TITLE:  
**Cable Route Access Point 20**

STATUS:  
**INFORMATION**

SCALE: As Shown	DATE: 18.10.22	DRAWN: SG	CHECKED: SM	APPROVED: JD
--------------------	-------------------	--------------	----------------	-----------------

JOB NO: 2107-062	DRAWING NO: SK 120	REVISION: -
---------------------	-----------------------	----------------

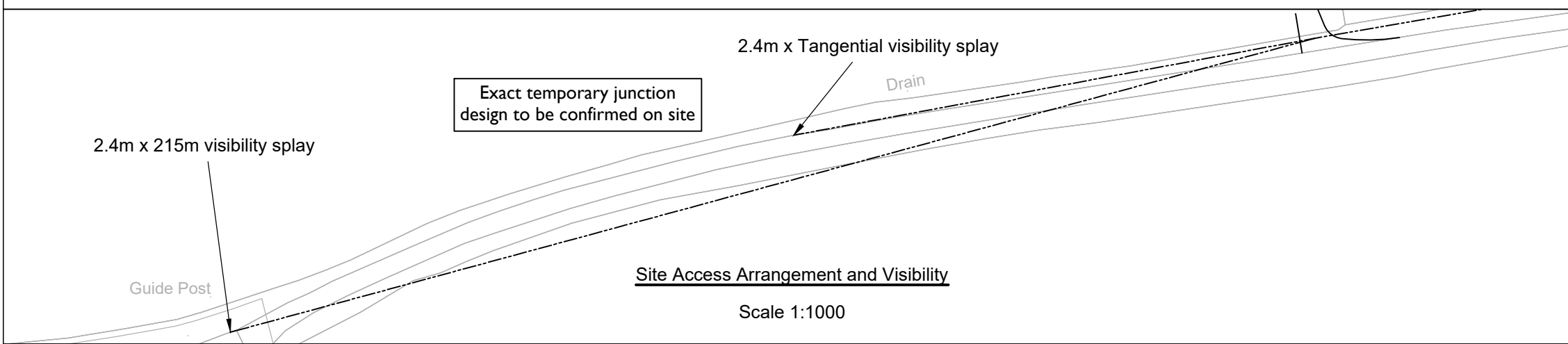

Site Access Arrangement and Visibility  
Scale 1:1000

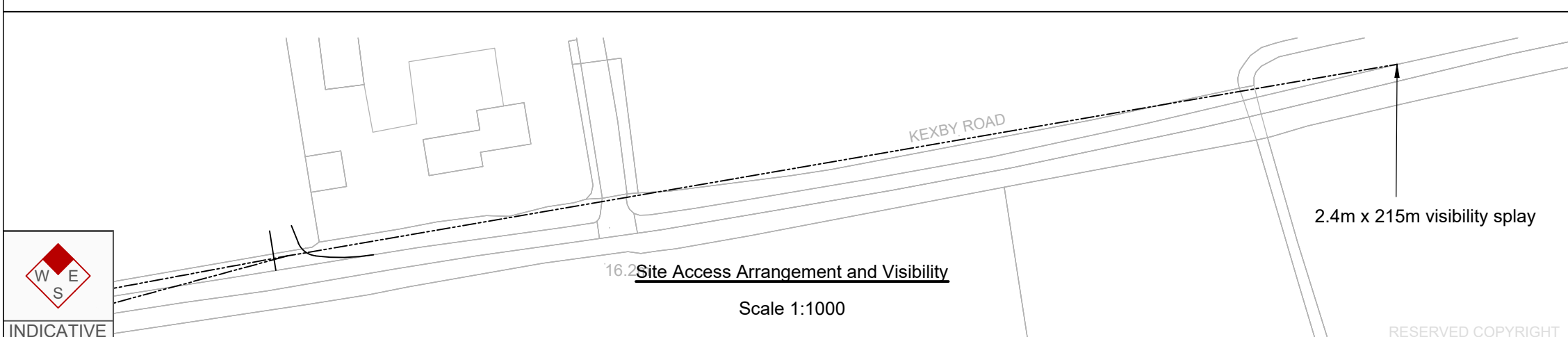

Site Access Arrangement and Visibility  
Scale 1:1000



RESERVED COPYRIGHT



**A3**  
ORIGINAL  
PLOT SIZE

Reproduced from Ordnance Survey Superplan Data with the permission of The Controller of Her Majesty's Stationery Office. Crown Copyright - Licence No. AL100034021

- NOTES:
1. The existing posted speed limit on Cow Lane is National Speed Limit (60mph)
  2. OS base to be confirmed with topographical survey
  3. Highway boundary to be confirmed

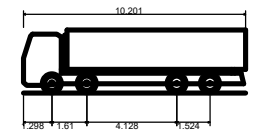

Large Tipper	10.201m
Overall Length	2.495m
Overall Width	2.890m
Overall Body Height	0.341m
Min Body Ground Clearance	2.471m
Track Width	6.00s
Lock to lock time	11.550m
Kerb to Kerb Turning Radius	

Rev	Date	Details	Drawn by	Checked by	Approved by
-	-	-	-	-	-

Banksman to assist accessing and egressing vehicles

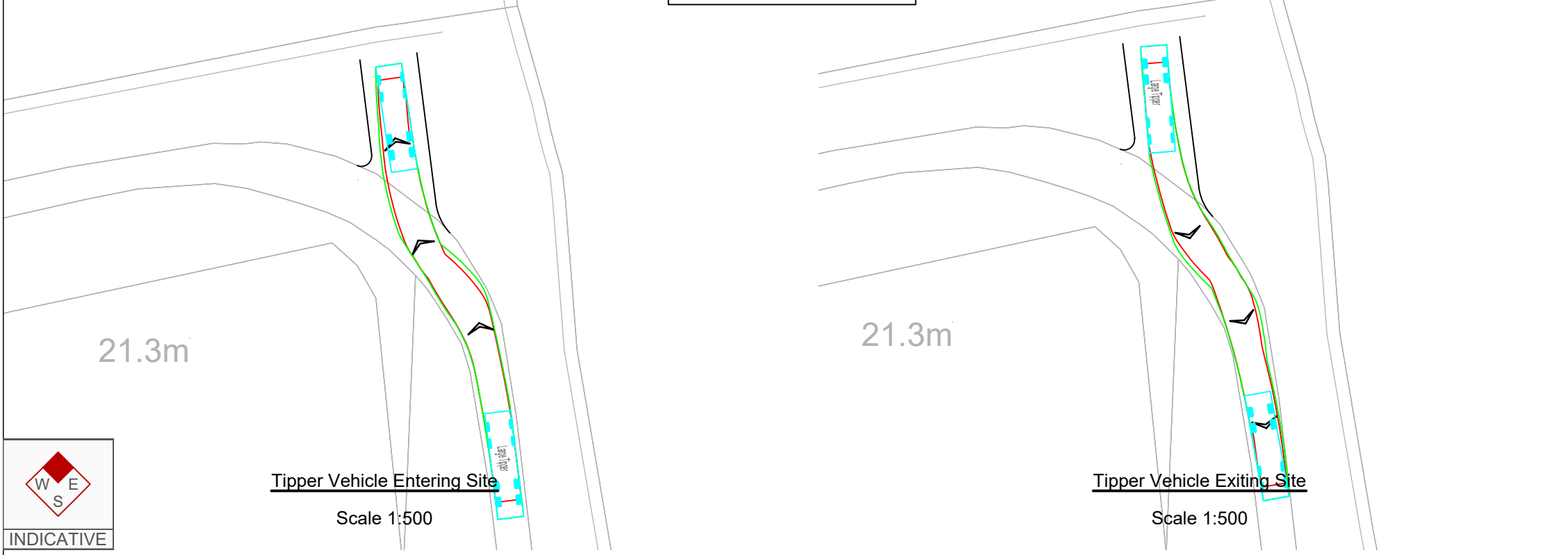

**Bristol**  
Cambridge  
London  
Manchester  
Oxford  
Welwyn Garden City

25 King Street  
Bristol  
BS1 4PB  
0117 925 9400  
[www.tpa.uk.com](http://www.tpa.uk.com)



CLIENT:  
**COTTAM SOLAR PROJECT LIMITED**

PROJECT:  
**COTTAM SOLAR FARM**

TITLE:  
**Cable Route Access Point 21**

STATUS:  
**INFORMATION**

SCALE:	DATE:	DRAWN:	CHECKED:	APPROVED:
As Shown	14.12.22	SG	SM	JD

JOB NO:	DRAWING NO:	REVISION:
2107-062	SK 121	-

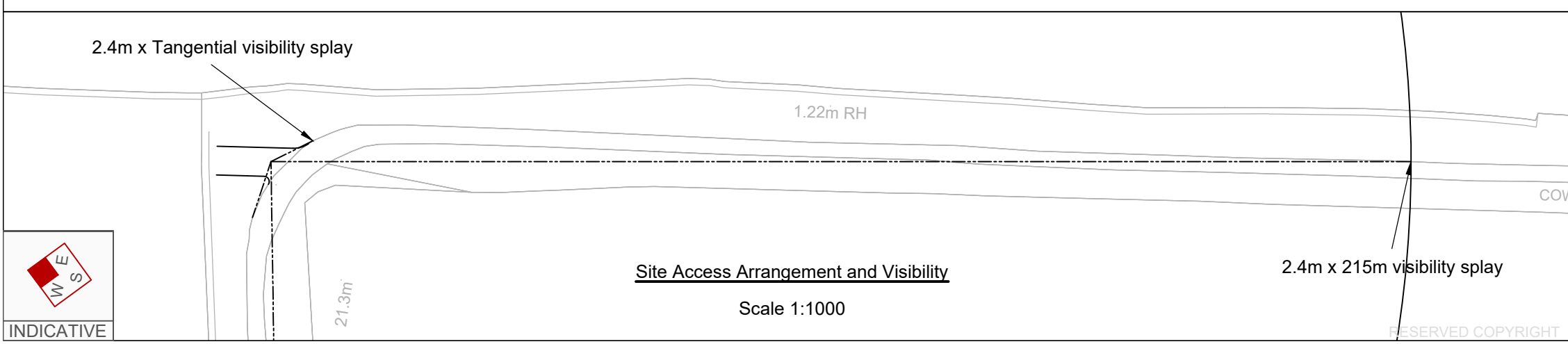
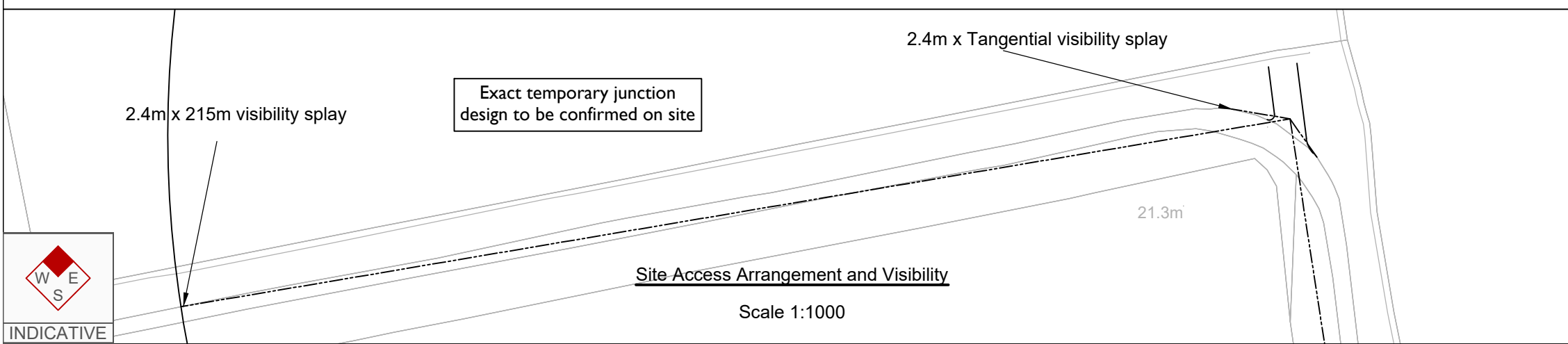

RESERVED COPYRIGHT

**A3**  
ORIGINAL  
PLOT SIZE

Banksman to assist accessing  
and egressing vehicles

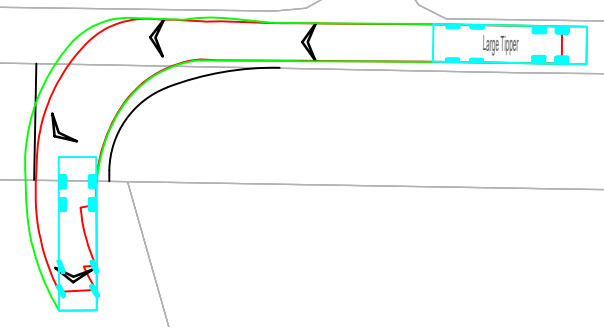

Tipper Vehicle Entering Site  
Scale 1:500

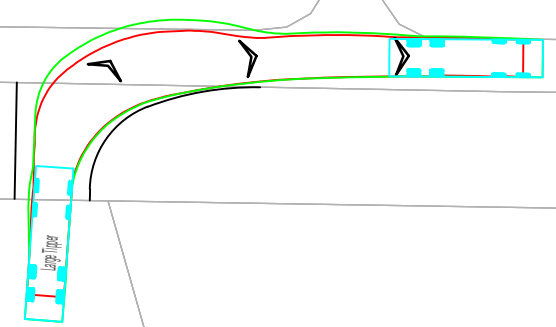

Tipper Vehicle Exiting Site  
Scale 1:500

Reproduced from Ordnance Survey Superplan Data with the permission of The Controller of Her Majesty's Stationery Office. Crown Copyright - Licence No. AL100034021

- NOTES:
1. The existing posted speed limit on Common Lane is National Speed Limit (60mph)
  2. OS base to be confirmed with topographical survey
  3. Highway boundary to be confirmed

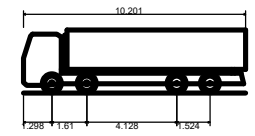

Large Tipper	10.201m
Overall Length	2.495m
Overall Width	2.890m
Overall Body Height	0.341m
Min Body Ground Clearance	2.471m
Track Width	6.00s
Lock to lock time	11.550m
Kerb to Kerb Turning Radius	

Rev	Date	Details	Drawn by	Checked by	Approved by
-	-	-	-	-	-

**Bristol**  
Cambridge  
London  
Manchester  
Oxford  
Welwyn Garden City



25 King Street  
Bristol  
BS1 4PB  
0117 925 9400  
[www.tpa.uk.com](http://www.tpa.uk.com)

CLIENT:  
**COTTAM SOLAR PROJECT LIMITED**

PROJECT:  
**COTTAM SOLAR FARM**

TITLE:  
**Cable Route Access Point 22**

STATUS:  
**INFORMATION**

SCALE: As Shown	DATE: 18.10.22	DRAWN: SG	CHECKED: SM	APPROVED: JD
JOB NO: 2107-062	DRAWING NO: SK 122	REVISION: -		

Exact temporary junction  
design to be confirmed on site

21.2m Cattle Grid

2.4m x 215m visibility splay

Site Access Arrangement and Visibility  
Scale 1:1000

24.4m

2.4m x 215m visibility splay

Site Access Arrangement and Visibility  
Scale 1:1000



INDICATIVE

RESERVED COPYRIGHT

**A3**  
ORIGINAL  
PLOT SIZE

Reproduced from Ordnance Survey Superplan Data with the permission of The Controller of Her Majesty's Stationery Office. Crown Copyright - Licence No. AL100034021

- NOTES:
1. The existing posted speed limit on Common Lane is National Speed Limit (60mph)
  2. OS base to be confirmed with topographical survey
  3. Highway boundary to be confirmed

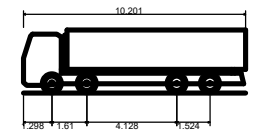

Large Tipper	10.201m
Overall Length	2.495m
Overall Width	2.890m
Overall Body Height	0.341m
Min Body Ground Clearance	2.471m
Track Width	6.00s
Lock to lock time	11.550m
Kerb to Kerb Turning Radius	

Rev	Date	Details	Drawn by	Checked by	Approved by
-	-	-	-	-	-

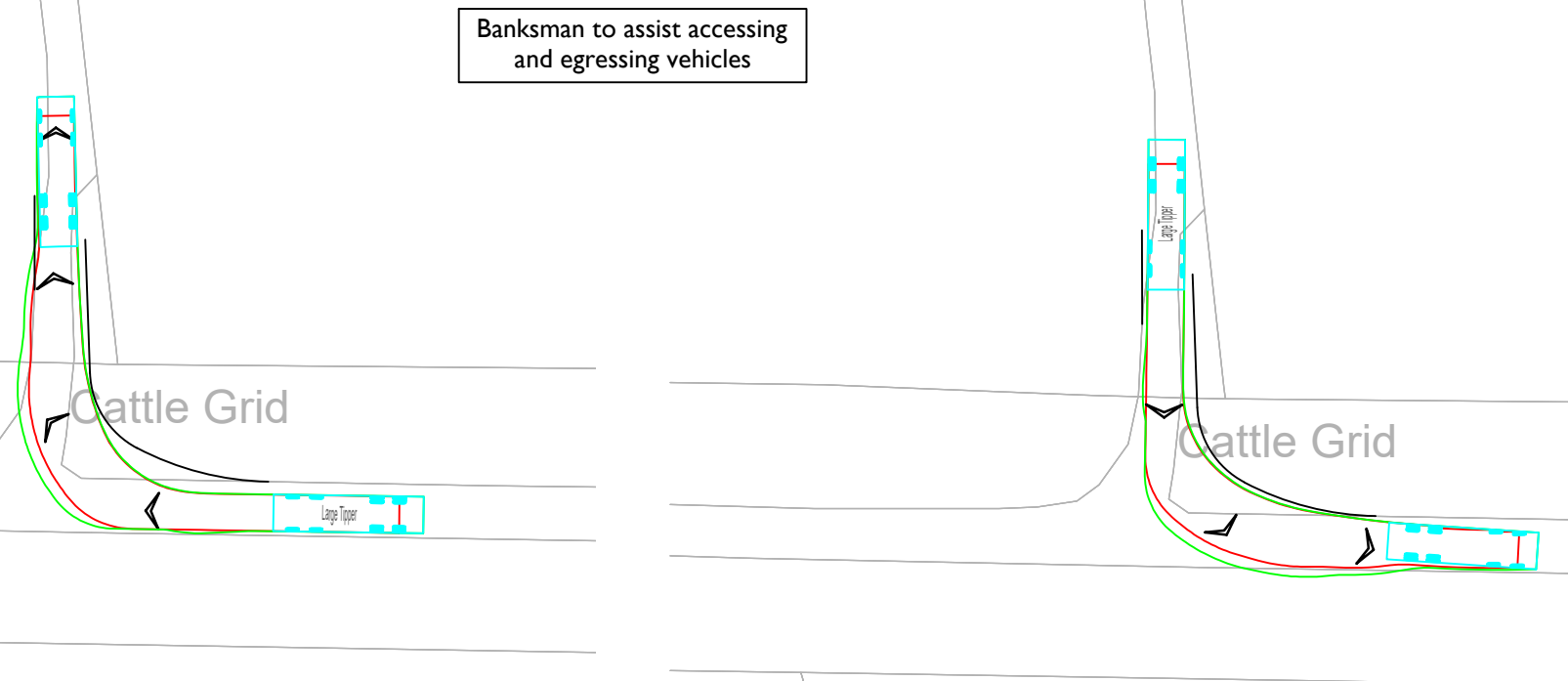

Tipper Vehicle Entering Site  
Scale 1:500

Tipper Vehicle Exiting Site  
Scale 1:500

**Bristol**  
Cambridge  
London  
Manchester  
Oxford  
Welwyn Garden City



25 King Street  
Bristol  
BS1 4PB  
0117 925 9400  
[www.tpa.uk.com](http://www.tpa.uk.com)

CLIENT:  
**COTTAM SOLAR PROJECT LIMITED**

PROJECT:  
**COTTAM SOLAR FARM**

TITLE:  
**Cable Route Access Point 23**

STATUS:  
**INFORMATION**

SCALE:	DATE:	DRAWN:	CHECKED:	APPROVED:
As Shown	18.10.22	SG	SM	JD

JOB NO:	DRAWING NO:	REVISION:
2107-062	SK 123	-

Exact temporary junction design to be confirmed on site

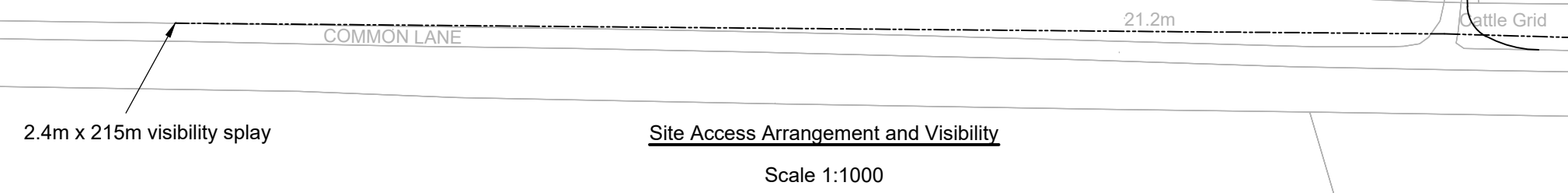

Site Access Arrangement and Visibility  
Scale 1:1000

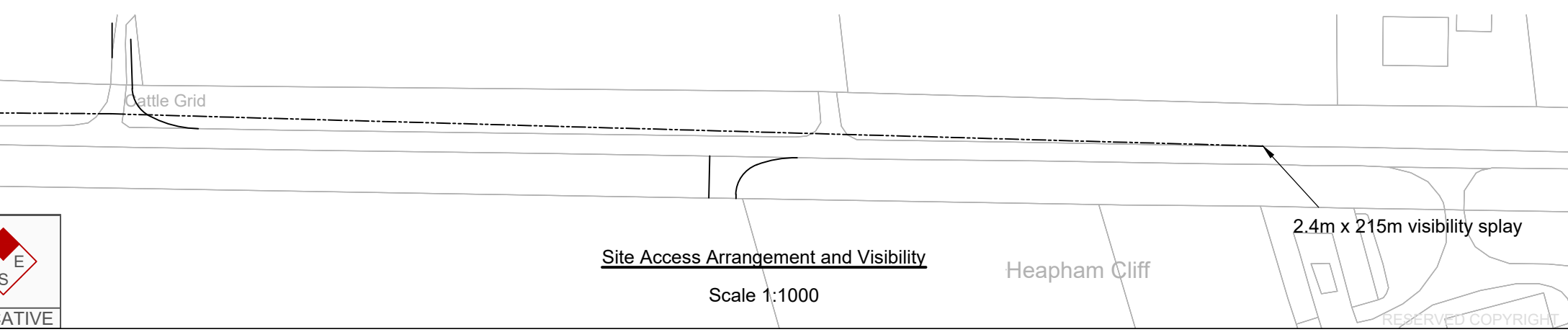

Site Access Arrangement and Visibility  
Scale 1:1000



INDICATIVE

**A3**  
ORIGINAL  
PLOT SIZE

Reproduced from Ordnance Survey Superplan Data with the permission of The Controller of Her Majesty's Stationery Office. Crown Copyright - Licence No. AL100034021

- NOTES:
1. The existing posted speed limit on School Lane is National Speed Limit (60mph)
  2. OS base to be confirmed with topographical survey
  3. Highway boundary to be confirmed

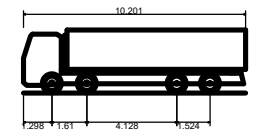

Large Tipper	10.201m
Overall Length	2.495m
Overall Width	2.890m
Overall Body Height	0.341m
Min Body Ground Clearance	2.471m
Track Width	6.00s
Lock to lock time	11.550m
Kerb to Kerb Turning Radius	

Banksman to assist accessing and egressing vehicles

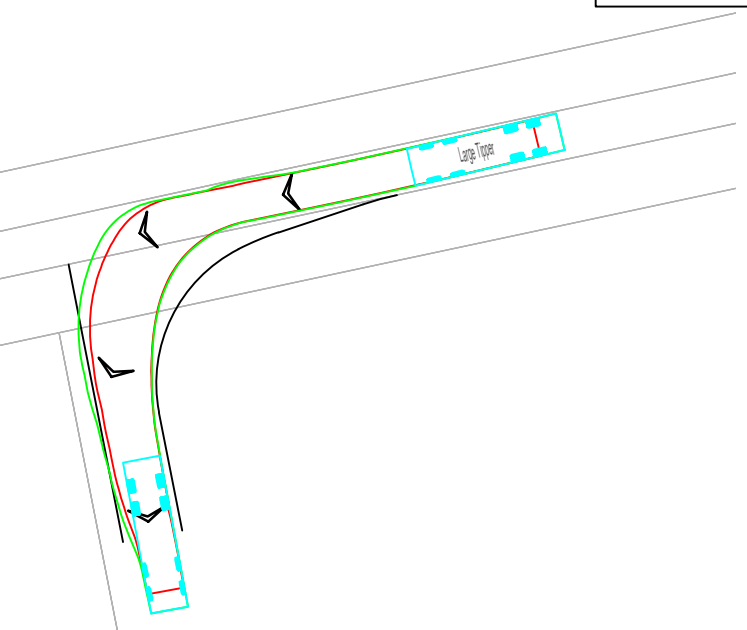

Tipper Vehicle Entering Site  
Scale 1:500

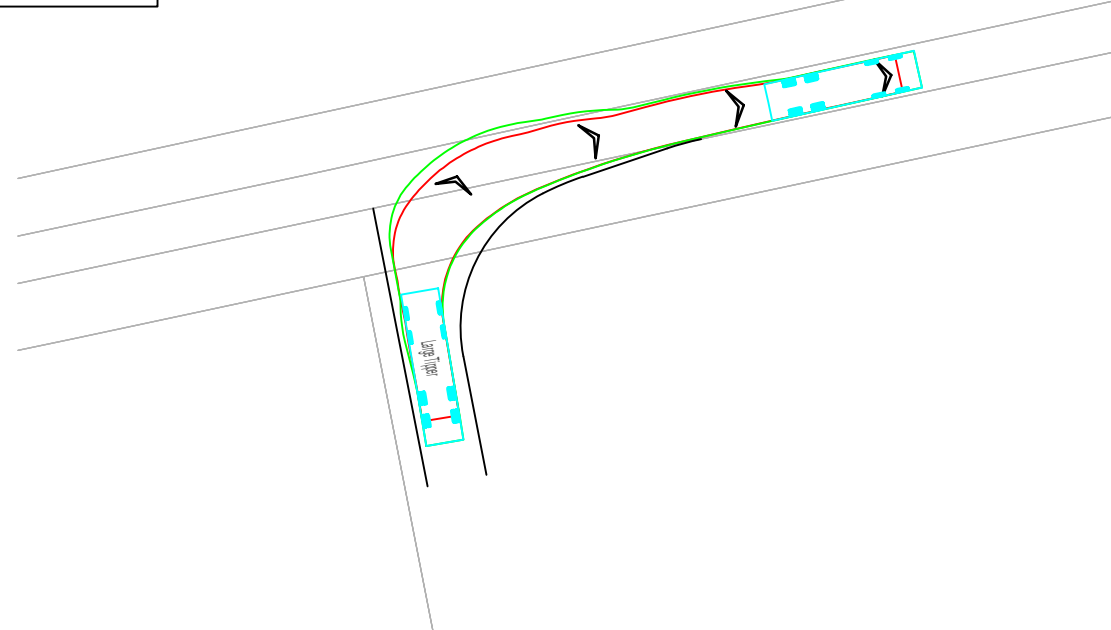

Tipper Vehicle Exiting Site  
Scale 1:500

Rev	Date	Details	Drawn by	Checked by	Approved by
A	16.10.23	Access moved east to coincide with existing field access.	PSW	RR	JD

**Bristol**  
Cambridge  
London  
Oxford  
Welwyn Garden City

25 King Street  
Bristol  
BS1 4PB  
0117 925 9400  
[www.tpa.uk.com](http://www.tpa.uk.com)

CLIENT:  
**COTTAM SOLAR PROJECT LIMITED**

PROJECT:  
**COTTAM SOLAR FARM**

TITLE:  
**Cable Route Access Point 24**

STATUS:  
**INFORMATION**

SCALE:	DATE:	DRAWN:	CHECKED:	APPROVED:
As Shown	18.10.22	SG	SM	JD

JOB NO:	DRAWING NO:	REVISION:
2107-062	SK 124	A

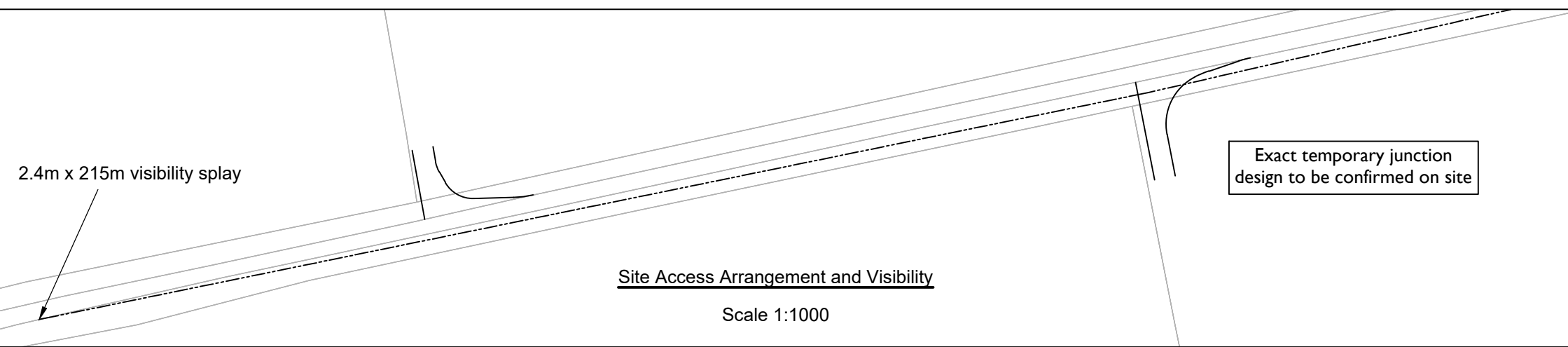

Site Access Arrangement and Visibility  
Scale 1:1000

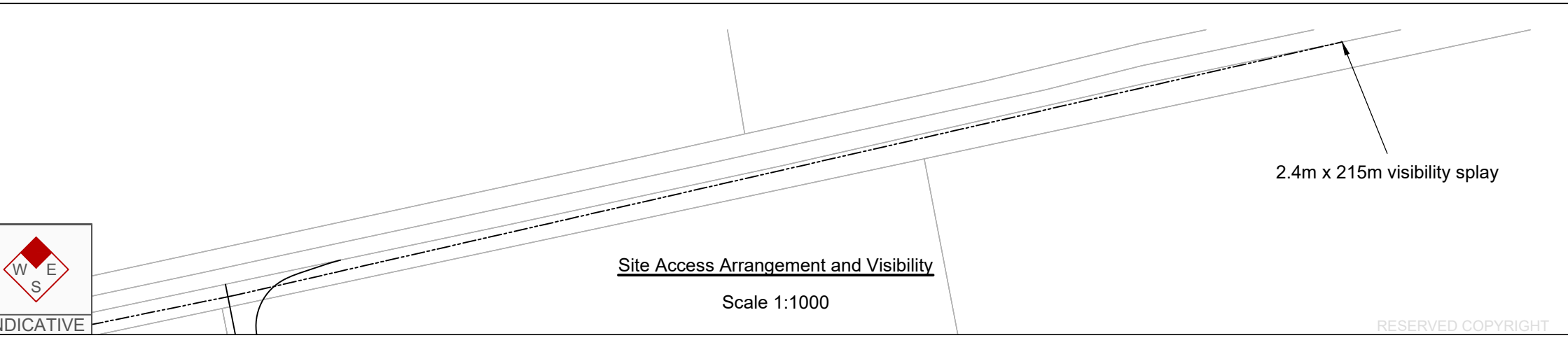

Site Access Arrangement and Visibility  
Scale 1:1000



RESERVED COPYRIGHT

**A3**  
ORIGINAL  
PLOT SIZE

Banksman to assist accessing  
and egressing vehicles

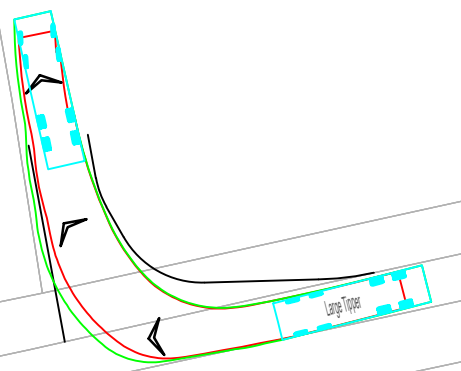

Tipper Vehicle Entering Site  
Scale 1:500

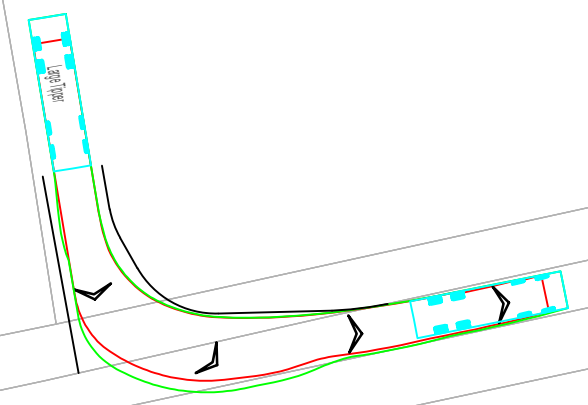

Tipper Vehicle Exiting Site  
Scale 1:500

Reproduced from Ordnance Survey Superplan Data with the permission of The Controller of Her Majesty's Stationery Office. Crown Copyright - Licence No. AL100034021

- NOTES:
1. The existing posted speed limit on School Lane is National Speed Limit (60mph)
  2. OS base to be confirmed with topographical survey
  3. Highway boundary to be confirmed

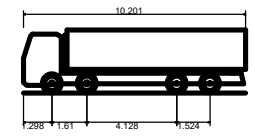

Large Tipper	10.201m
Overall Length	2.495m
Overall Width	2.890m
Overall Body Height	0.341m
Min Body Ground Clearance	2.471m
Track Width	6.00s
Lock to lock time	11.550m
Kerb to Kerb Turning Radius	

Rev	Date	Details	Drawn by	Checked by	Approved by
-	-	-	-	-	-

**Bristol**  
Cambridge  
London  
Manchester  
Oxford  
Welwyn Garden City

25 King Street  
Bristol  
BS1 4PB  
0117 925 9400  
[www.tpa.uk.com](http://www.tpa.uk.com)



CLIENT:  
**COTTAM SOLAR PROJECT LIMITED**

PROJECT:  
**COTTAM SOLAR FARM**

TITLE:  
**Cable Route Access Point 25**

STATUS:  
**INFORMATION**

SCALE:	DATE:	DRAWN:	CHECKED:	APPROVED:
As Shown	18.10.22	SG	SM	JD

JOB NO:	DRAWING NO:	REVISION:
2107-062	SK 125	-

2.4m x 215m visibility splay

Exact temporary junction  
design to be confirmed on site

Site Access Arrangement and Visibility  
Scale 1:1000

2.4m x 215m visibility splay

Site Access Arrangement and Visibility  
Scale 1:1000



RESERVED COPYRIGHT

A3

ORIGINAL PLOT SIZE

Banksman to assist accessing and egressing vehicles

1.22m RH

Tipper Vehicle Entering Site

Scale 1:500

1.22m RH

Tipper Vehicle Exiting Site

Scale 1:500

Reproduced from Ordnance Survey Superplan Data with the permission of The Controller of Her Majesty's Stationery Office. Crown Copyright - Licence No. AL100034021

NOTES:

- 1. The existing posted speed limit on A631 is National Speed Limit (60mph)
- 2. OS base to be confirmed with topographical survey
- 3. Highway boundary to be confirmed

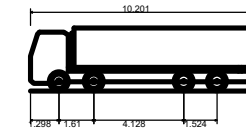

Large Tipper  
 Overall Length 10.201m  
 Overall Width 2.495m  
 Overall Body Height 2.890m  
 Min Body Ground Clearance 0.341m  
 Track Width 2.471m  
 Lock to lock time 6.00s  
 Kerb to Kerb Turning Radius 11.550m

Rev	Date	Details	Drawn by	Checked by	Approved by
-	-	-	-	-	-

Bristol  
 Cambridge  
 London  
 Manchester  
 Oxford  
 Welwyn Garden City



25 King Street  
 Bristol  
 BS1 4PB  
 0117 925 9400  
[www.tpa.uk.com](http://www.tpa.uk.com)

CLIENT:

COTTAM SOLAR PROJECT LIMITED

PROJECT:

COTTAM SOLAR FARM

TITLE:

Cable Route Access Point 26

STATUS:

INFORMATION

SCALE:	DATE:	DRAWN:	CHECKED:	APPROVED:
As Shown	18.10.22	SG	SM	JD

JOB NO:	DRAWING NO:	REVISION:
2107-062	SK 126	-

20.3m

Exact temporary junction design to be confirmed on site

2.4m x Tangential visibility splay

2.4m x 215m visibility splay

Site Access Arrangement and Visibility

Scale 1:1000

Track

1.22m RH

Track

21.1m

1.22m RH

2.4m x 215m visibility splay

Site Access Arrangement and Visibility

Scale 1:1000



INDICATIVE

RESERVED COPYRIGHT

A3

ORIGINAL PLOT SIZE

Banksman to assist accessing and egressing vehicles

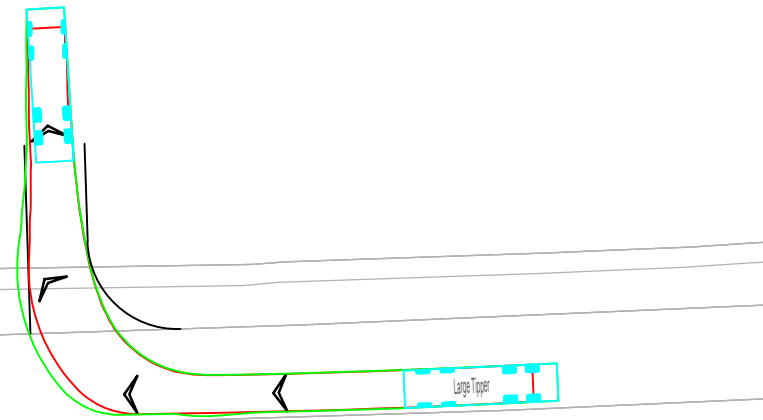

Tipper Vehicle Entering Site  
Scale 1:500

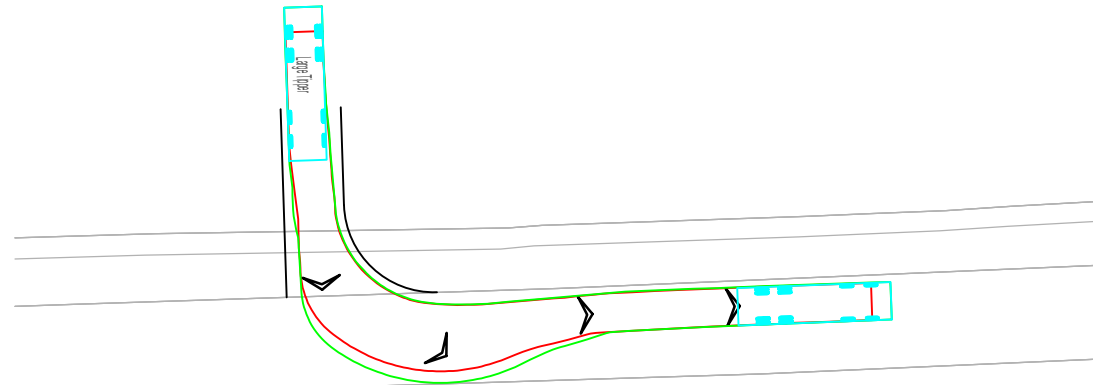

Tipper Vehicle Exiting Site  
Scale 1:500

2.4m x 215m visibility splay

Exact temporary junction design to be confirmed on site

21.1m

1.22m RH

Site Access Arrangement and Visibility  
Scale 1:1000

2.4m x 215m visibility splay

A631

Site Access Arrangement and Visibility  
Scale 1:1000



INDICATIVE

RESERVED COPYRIGHT

Reproduced from Ordnance Survey Superplan Data with the permission of The Controller of Her Majesty's Stationery Office. Crown Copyright - Licence No. AL100034021

NOTES:

- 1. The existing posted speed limit on A631 is National Speed Limit (60mph)
- 2. OS base to be confirmed with topographical survey
- 3. Highway boundary to be confirmed

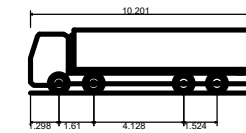

Large Tipper	10.201m
Overall Length	2.495m
Overall Width	2.890m
Overall Body Height	0.341m
Min Body Ground Clearance	2.471m
Track Width	6.00s
Lock to lock time	11.550m
Kerb to Kerb Turning Radius	

Rev	Date	Details	Drawn by	Checked by	Approved by
-	-	-	-	-	-

Bristol  
Cambridge  
London  
Manchester  
Oxford  
Welwyn Garden City



25 King Street  
Bristol  
BS1 4PB  
0117 925 9400  
[www.tpa.uk.com](http://www.tpa.uk.com)

CLIENT:  
COTTAM SOLAR PROJECT LIMITED

PROJECT:  
COTTAM SOLAR FARM

TITLE:  
Cable Route Access Point 27

STATUS:  
INFORMATION

SCALE: As Shown	DATE: 18.10.22	DRAWN: SG	CHECKED: SM	APPROVED: JD
JOB NO: 2107-062		DRAWING NO: SK 127		REVISION: -

**A3**  
ORIGINAL  
PLOT SIZE

Reproduced from Ordnance Survey Superplan Data with the permission of The Controller of Her Majesty's Stationery Office. Crown Copyright - Licence No. AL100034021

- NOTES:
1. The existing posted speed limit is National Speed Limit (60mph)
  2. OS base to be confirmed with topographical survey
  3. Highway boundary to be confirmed

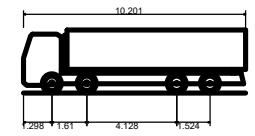

Large Tipper  
Overall Length 10.201m  
Overall Width 2.495m  
Overall Body Height 2.890m  
Min Body Ground Clearance 0.341m  
Track Width 2.471m  
Lock to lock time 6.00s  
Kerb to Kerb Turning Radius 11.550m

Rev	Date	Details	Drawn by	Checked by	Approved by
-	-	-	-	-	-

Banksman to assist accessing and egressing vehicles

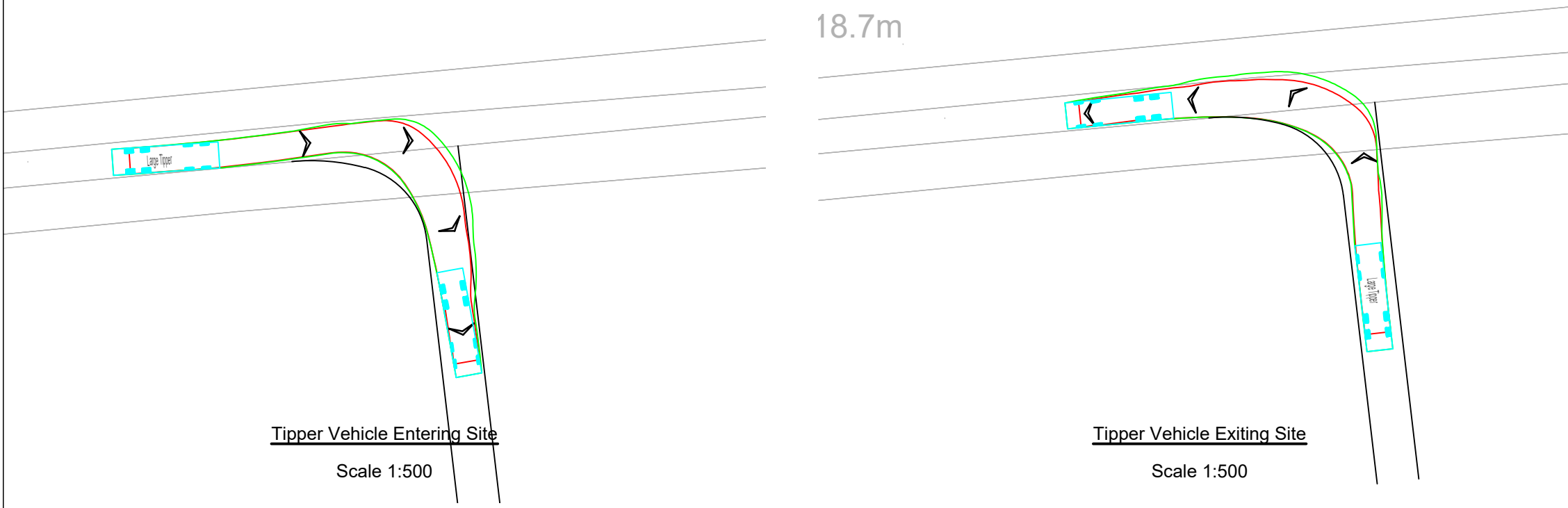

Bristol  
Cambridge  
London  
Manchester  
Oxford  
Welwyn Garden City

25 King Street  
Bristol  
BS1 4PB  
0117 925 9400  
[www.tpa.uk.com](http://www.tpa.uk.com)



CLIENT:  
**COTTAM SOLAR PROJECT LIMITED**

PROJECT:  
**COTTAM SOLAR FARM**

TITLE:  
**Cable Route Access Point 28**

STATUS:  
**INFORMATION**

SCALE: As Shown	DATE: 18.10.22	DRAWN: SG	CHECKED: SM	APPROVED: JD
--------------------	-------------------	--------------	----------------	-----------------

JOB NO: 2107-062	DRAWING NO: SK 128	REVISION: -
---------------------	-----------------------	----------------

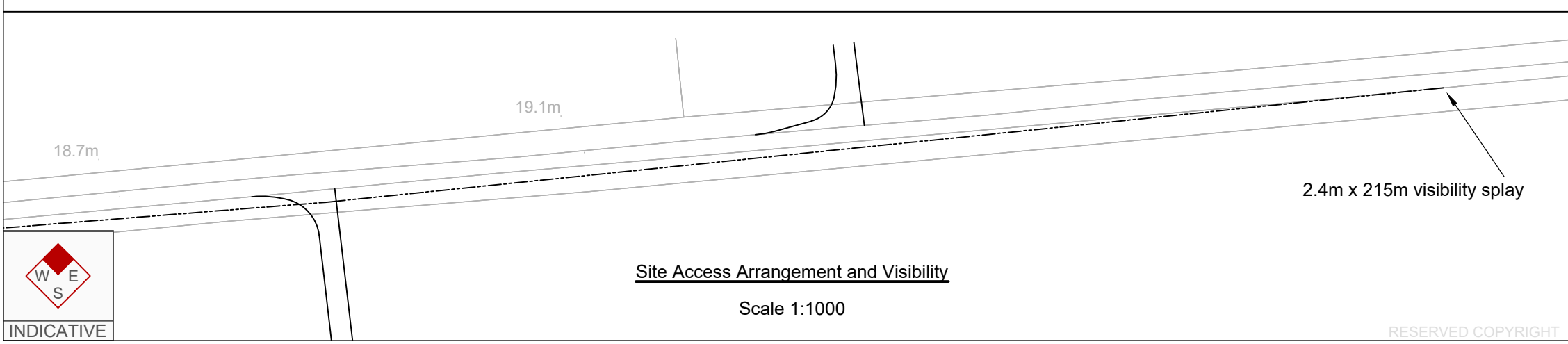
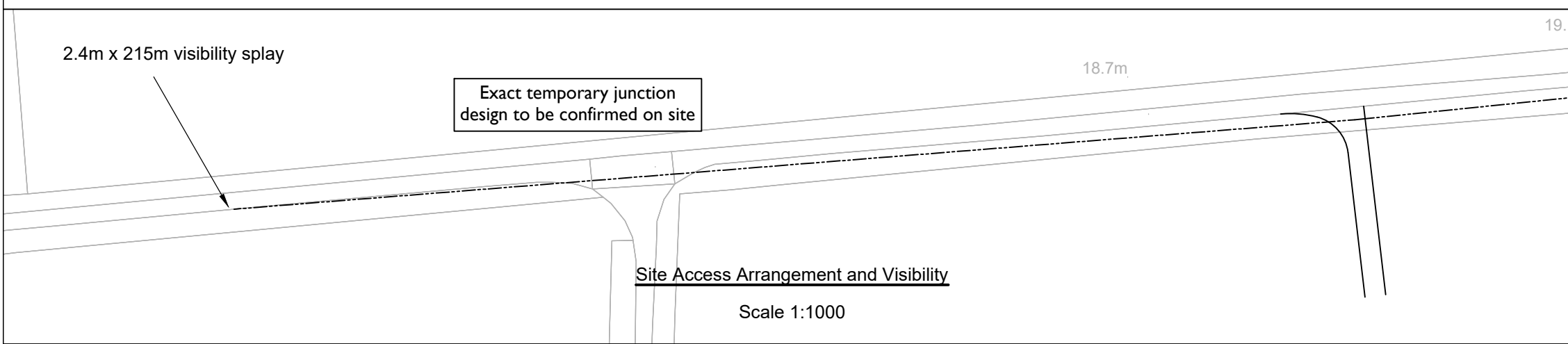

RESERVED COPYRIGHT



**A3**  
ORIGINAL  
PLOT SIZE

Banksman to assist accessing  
and egressing vehicles

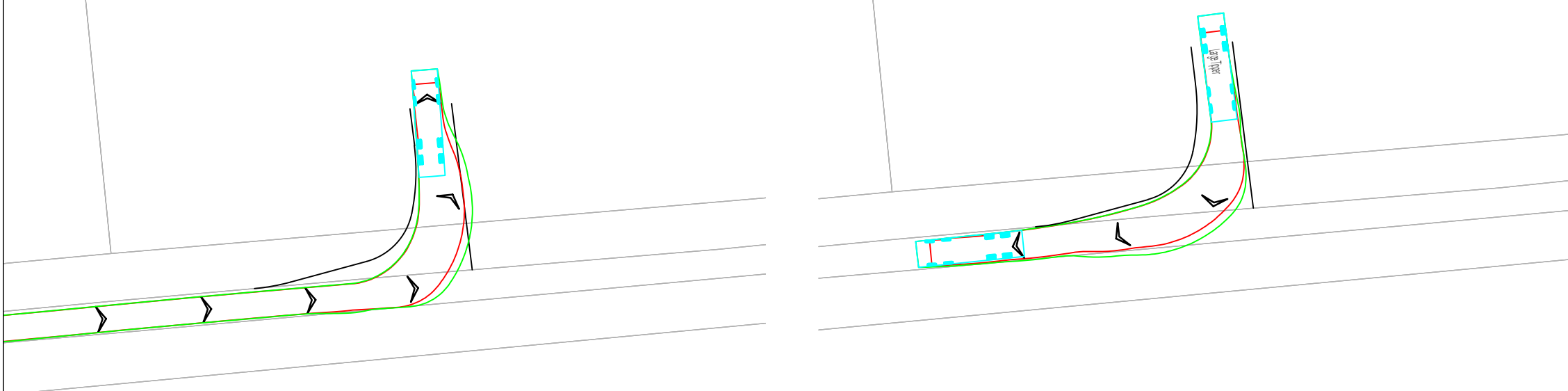

Tipper Vehicle Entering Site  
Scale 1:500

Tipper Vehicle Exiting Site  
Scale 1:500

Reproduced from Ordnance Survey Superplan Data with the permission of The Controller of Her Majesty's Stationery Office. Crown Copyright - Licence No. AL100034021

- NOTES:
1. The existing posted speed limit is National Speed Limit (60mph)
  2. OS base to be confirmed with topographical survey
  3. Highway boundary to be confirmed

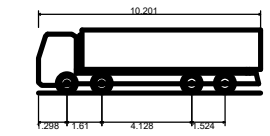

Large Tipper	10.201m
Overall Length	2.495m
Overall Width	2.890m
Overall Body Height	0.341m
Min Body Ground Clearance	2.471m
Track Width	6.00s
Lock to lock time	11.550m
Kerb to Kerb Turning Radius	

Rev	Date	Details	Drawn by	Checked by	Approved by
-	-	-	-	-	-

**Bristol**  
Cambridge  
London  
Manchester  
Oxford  
Welwyn Garden City

25 King Street  
Bristol  
BS1 4PB  
0117 925 9400  
[www.tpa.uk.com](http://www.tpa.uk.com)

CLIENT:  
**COTTAM SOLAR PROJECT LIMITED**

PROJECT:  
**COTTAM SOLAR FARM**

TITLE:  
**Cable Route Access Point 29**

STATUS:  
**INFORMATION**

SCALE: As Shown	DATE: 18.10.22	DRAWN: SG	CHECKED: SM	APPROVED: JD
--------------------	-------------------	--------------	----------------	-----------------

JOB NO: 2107-062	DRAWING NO: SK 129	REVISION: -
---------------------	-----------------------	----------------

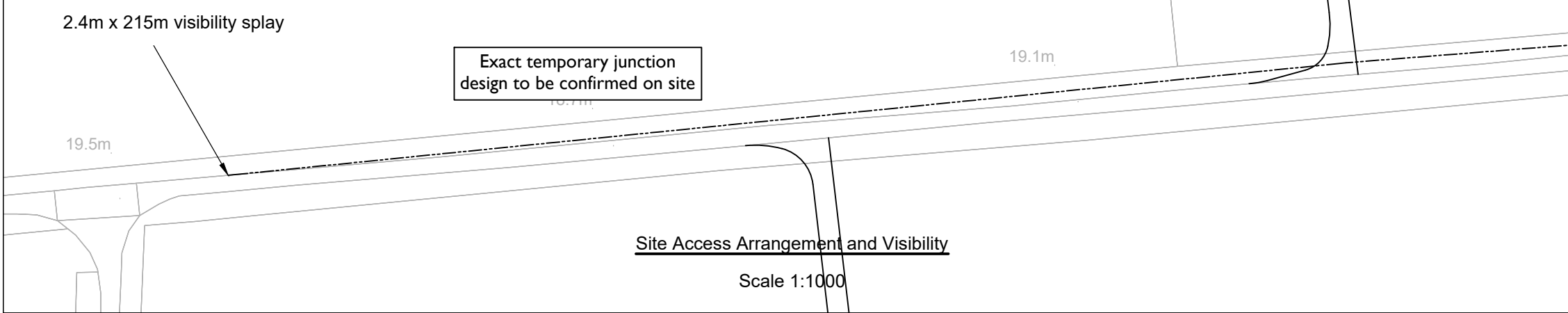

Site Access Arrangement and Visibility  
Scale 1:1000

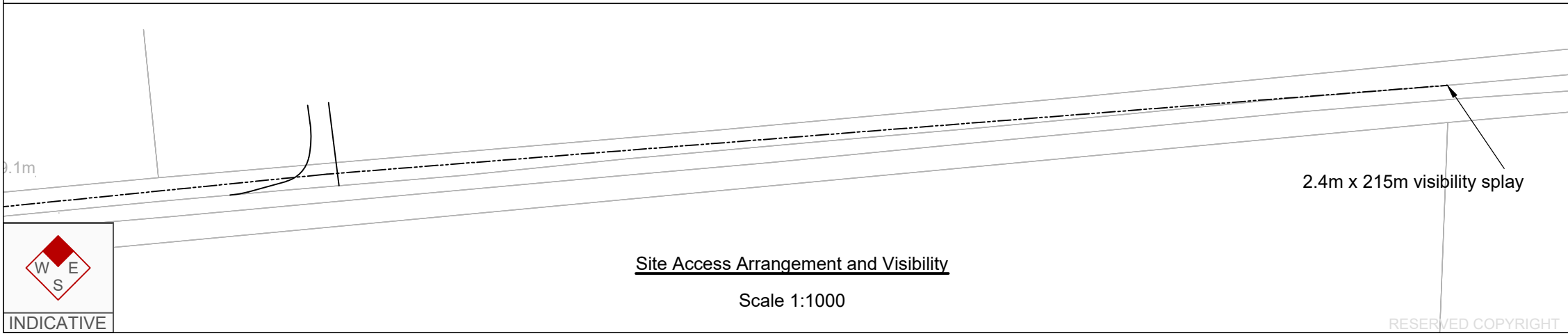

Site Access Arrangement and Visibility  
Scale 1:1000



RESERVED COPYRIGHT

A3

ORIGINAL PLOT SIZE

Banksman to assist accessing and egressing vehicles

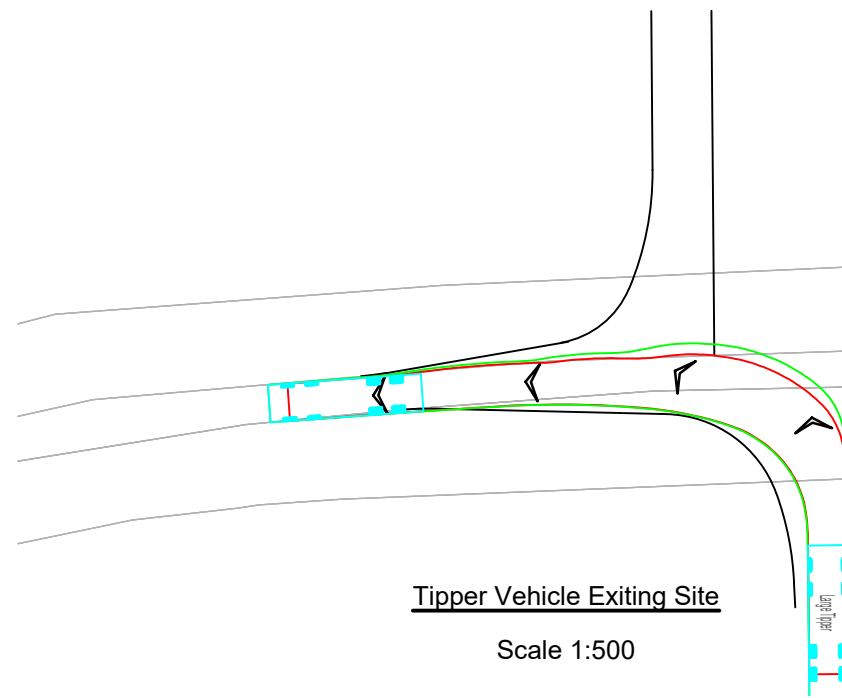
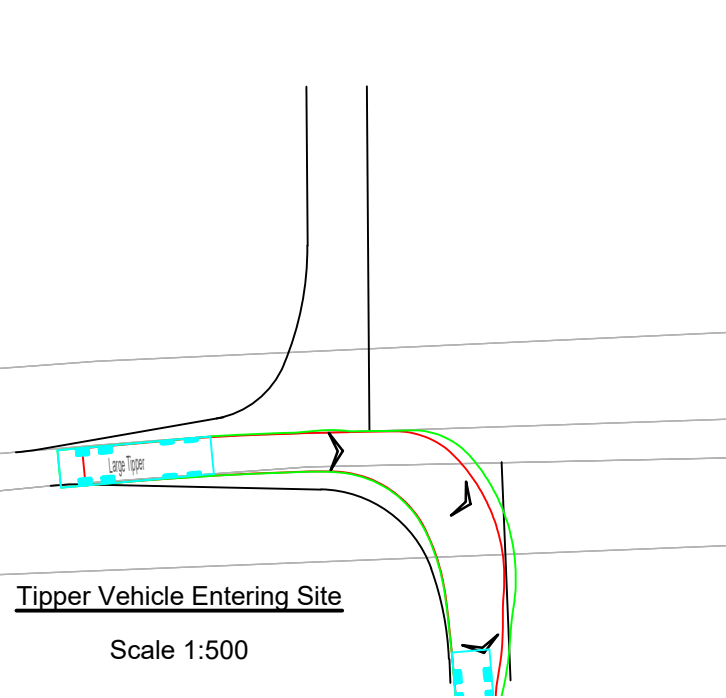

Reproduced from Ordnance Survey Superplan Data with the permission of The Controller of Her Majesty's Stationery Office. Crown Copyright - Licence No. AL100034021

NOTES:

1. The existing posted speed limit on Green Lane is National Speed Limit (60mph)
2. OS base to be confirmed with topographical survey
3. Highway boundary to be confirmed

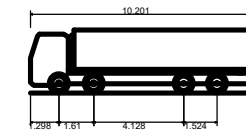

Large Tipper	10.201m
Overall Length	2.495m
Overall Width	2.890m
Overall Body Height	0.341m
Min Body Ground Clearance	2.471m
Track Width	6.00s
Lock to lock time	11.550m
Kerb to Kerb Turning Radius	

Rev	Date	Details	Drawn by	Checked by	Approved by
-	-	-	-	-	-

Bristol  
Cambridge  
London  
Manchester  
Oxford  
Welwyn Garden City



25 King Street  
Bristol  
BS1 4PB  
0117 925 9400  
[www.tpa.uk.com](http://www.tpa.uk.com)

CLIENT:  
**COTTAM SOLAR PROJECT LIMITED**

PROJECT:  
**COTTAM SOLAR FARM**

TITLE:  
**Cable Route Access Point 30**

STATUS:  
**INFORMATION**

SCALE:	DATE:	DRAWN:	CHECKED:	APPROVED:
As Shown	18.10.22	SG	SM	JD

JOB NO:	DRAWING NO:	REVISION:
2107-062	SK 130	-

Exact temporary junction design to be confirmed on site

2.4m x 215m visibility splay

GREEN LANE

**Site Access Arrangement and Visibility**  
Scale 1:1000

2.4m x 215m visibility splay

**Site Access Arrangement and Visibility**  
Scale 1:1000



INDICATIVE

RESERVED COPYRIGHT

**A3**  
ORIGINAL  
PLOT SIZE

Banksman to assist accessing  
and egressing vehicles

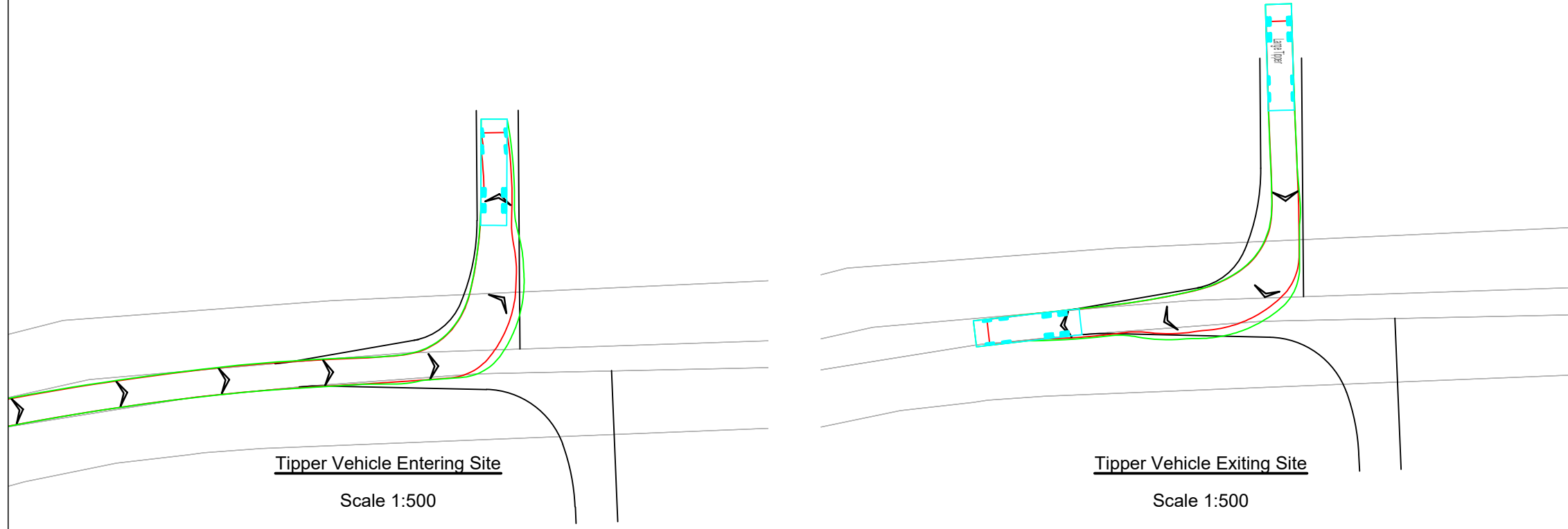

Reproduced from Ordnance Survey Superplan Data with the permission of The Controller of Her Majesty's Stationery Office. Crown Copyright - Licence No. AL100034021

- NOTES:
1. The existing posted speed limit on Green Lane is National Speed Limit (60mph)
  2. OS base to be confirmed with topographical survey
  3. Highway boundary to be confirmed

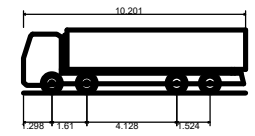

Large Tipper	10.201m
Overall Length	2.495m
Overall Width	2.890m
Overall Body Height	0.341m
Min Body Ground Clearance	2.471m
Track Width	6.00s
Lock to lock time	11.550m
Kerb to Kerb Turning Radius	

Rev	Date	Details	Drawn by	Checked by	Approved by
-	-	-	-	-	-

**Bristol**  
Cambridge  
London  
Manchester  
Oxford  
Welwyn Garden City



Transport Planning Associates

25 King Street  
Bristol  
BS1 4PB  
0117 925 9400  
[www.tpa.uk.com](http://www.tpa.uk.com)

CLIENT:  
**COTTAM SOLAR PROJECT LIMITED**

PROJECT:  
**COTTAM SOLAR FARM**

TITLE:  
**Cable Route Access Point 31**

STATUS:  
**INFORMATION**

SCALE:	DATE:	DRAWN:	CHECKED:	APPROVED:
As Shown	18.10.22	SG	SM	JD

JOB NO:	DRAWING NO:	REVISION:
2107-062	SK 131	-

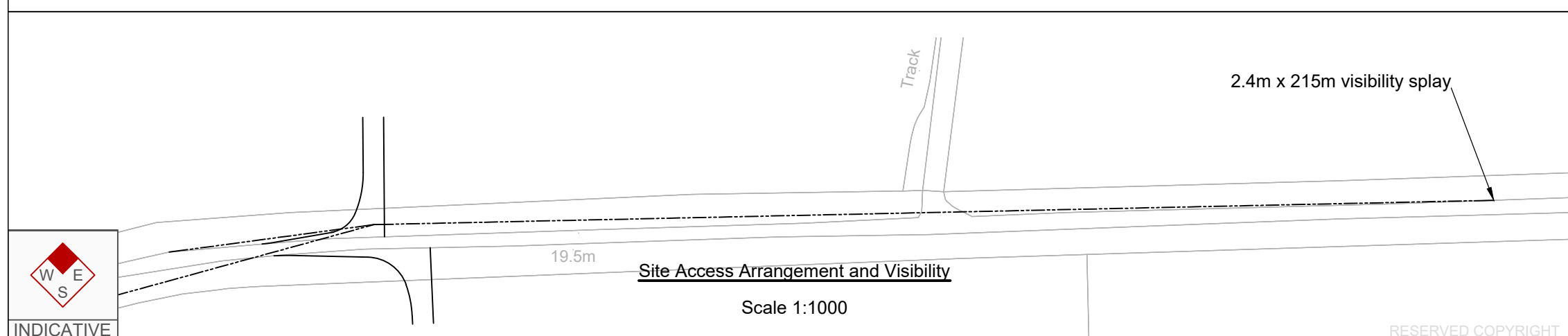
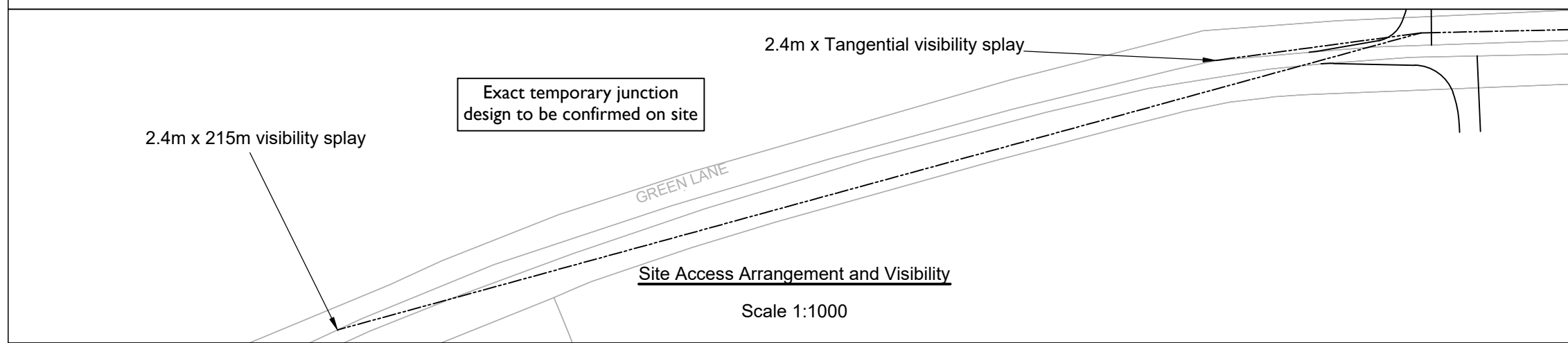

INDICATIVE

RESERVED COPYRIGHT

**A3**  
ORIGINAL  
PLOT SIZE

Banksman to assist accessing  
and egressing vehicles

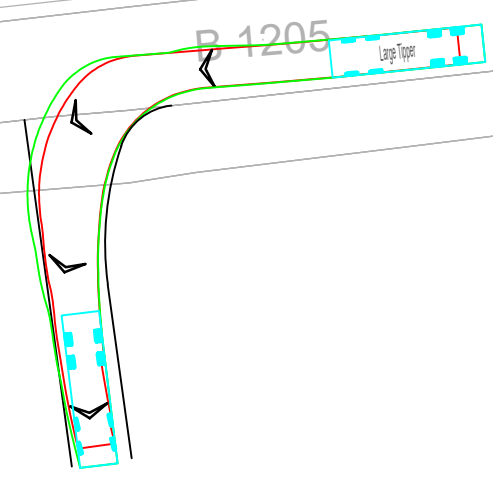

Tipper Vehicle Entering Site  
Scale 1:500

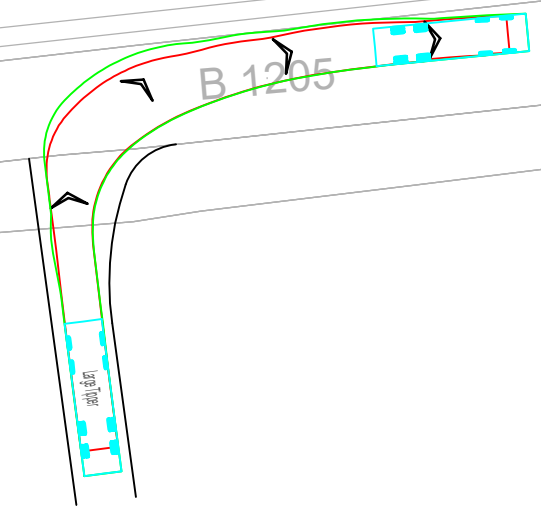

Tipper Vehicle Exiting Site  
Scale 1:500

Reproduced from Ordnance Survey Superplan Data with the permission of The Controller of Her Majesty's Stationery Office. Crown Copyright - Licence No. AL100034021

- NOTES:
1. The existing posted speed limit on B1205 is National Speed Limit (60mph)
  2. OS base to be confirmed with topographical survey
  3. Highway boundary to be confirmed

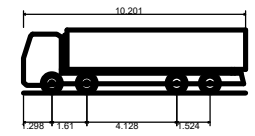

Large Tipper	10.201m
Overall Length	2.495m
Overall Width	2.890m
Overall Body Height	0.341m
Min Body Ground Clearance	2.471m
Track Width	6.00s
Lock to lock time	11.550m
Kerb to Kerb Turning Radius	

Rev	Date	Details	Drawn by	Checked by	Approved by
-	-	-	-	-	-

Bristol  
Cambridge  
London  
Manchester  
Oxford  
Welwyn Garden City



25 King Street  
Bristol  
BS1 4PB  
0117 925 9400  
[www.tpa.uk.com](http://www.tpa.uk.com)

CLIENT:  
**COTTAM SOLAR PROJECT LIMITED**

PROJECT:  
**COTTAM SOLAR FARM**

TITLE:  
**Cable Route Access Point 32**

STATUS:  
**INFORMATION**

SCALE:	DATE:	DRAWN:	CHECKED:	APPROVED:
As Shown	18.10.22	SG	SM	JD

JOB NO:	DRAWING NO:	REVISION:
2107-062	SK 132	-

Exact temporary junction  
design to be confirmed on site

2.4m x 215m visibility splay

Site Access Arrangement and Visibility  
Scale 1:1000

B 1205

B 1205

20.6m

2.4m x 215m visibility splay

Site Access Arrangement and Visibility  
Scale 1:1000



INDICATIVE

RESERVED COPYRIGHT

# APPENDIX D

Cottam Solar Projects Limited

Cottam Solar Project,  
Lincolnshire

Project Reference: 2107-062/TN/01

Construction Worker Travel Plan



25 King Street  
Bristol  
BS1 4PB

0117 925 9400  
bristol@tpa.uk.com  
www.tpa.uk.com

## 1 Introduction

1.1 This Construction Worker Travel Plan (CWTP) has been prepared by Transport Planning Associates (TPA) on behalf of Cottam Solar Project Ltd (the 'Applicant') in relation to an application for a Development Consent Order (DCO) for Cottam Solar Project (hereafter referred to as the 'Scheme'). It supports the Construction Traffic Management Plan which forms **Appendix 14.2** of the **Environmental Statement**. It has been prepared to encourage construction workers to travel to the Site via sustainable modes of transport, where possible, during the construction phase of the proposed development.

### Aims and Objectives

1.2 Travel planning presents the opportunity to raise awareness of the consequences of travel choices, the benefits of alternatives and the opportunity to minimise the impact of motorised travel on the environment. A Travel Plan can bring the following benefits:

- To the individual - through improved health, reduced stress and cost savings;
- To the community - by the developer demonstrating commitment to environmental priorities and setting an example to others; and
- To the environment - through improved local air quality with less noise, dirt and fumes, which can contribute to other national and global improvements.

1.3 The core aims of this Construction Worker Travel Plan are to:

- Set out the objectives of travel planning at the Site;
- Set out information on the accessibility of the Site by non-car modes of transport;
- Set out initiatives and measures to promote accessibility by non-car modes, including the proposed construction worker minibus arrangement; and
- Set out the management requirements of the Travel Plan.

1.4 The following key aims and objectives are identified:

- To reduce single occupancy car travel by construction workers;
- To increase car sharing and minibus use;
- To increase knowledge of the public transport opportunities available to construction workers.

1.5 The remainder of this travel plan includes the following Chapters:

- Chapter 2: Management Strategy; and
- Chapter 3: Measures.

## 2 Management Strategy

### Roles and Responsibilities

- 2.1 A Travel Plan Coordinator (TPC) will be appointed to oversee the implementation of this Travel Plan. The TPC will be responsible for overseeing the implementation of measures and ensuring the objectives set out in **Chapter 1** are achieved.
- 2.2 The responsibilities of the TPC will comprise, but not necessarily be limited to, the following:
- Implement measures set out in the Travel Plan;
  - Raise awareness of the Travel Plan; and
  - Provide advice to construction workers regarding sustainable travel.
- 2.3 It is anticipated that the TPC will be the Construction Site Manager (CSM) or a member of the project management team.



### 3 Measures

3.1 A number of measures have been identified that will be implemented in order to help achieve the objectives of this Travel Plan. The main objective is to reduce single occupancy vehicle travel to the Site by construction workers. A summary of the proposed measures is provided in **Table 3.1** below.

Table 3.1 Proposed Travel Plan Measures

Item	Measure	Responsible
1	Establish car share scheme for construction workers, including a 'guaranteed lift home' policy (details below).	TPC
2	Arrange on-site facilities for workers, such as storage lockers for equipment.	Contractor
3	Provide a map with identified cycling routes to the Site on a noticeboard in communal areas.	TPC
4	Provide bus timetable information and bus routes to the Site on a noticeboard in communal areas.	TPC
5	Provide emergency cycle repair kit on-site.	TPC
6	Provision of construction worker shuttlebus (details below).	Contractor
7	Encourage travel outside of highway network peak hours.	TPC
8	Encourage use of electric vehicles (EV).	TPC
9	Appointment of Travel Plan Coordinator.	Project Management Team

3.2 The measures outlined in **Table 3.1** will be continuously reviewed by the TPC to ensure they remain effective in encouraging travel to the Site by non-car modes.

#### Car Share Scheme

3.3 There is potential for car sharing to also occur between construction workers, especially if they are travelling from the same origin place to the Site.

- 3.4 The TPC will be responsible for determining which staff members may benefit from car sharing and form car sharing group for the Site for workers to communicate availability and schedule car shares between each other.
- 3.5 The TPC will promote a car-sharing scheme throughout the construction program. The TPC would also make construction workers aware of existing car sharing schemes such as [liftshare.com/uk](https://liftshare.com/uk).

### **Construction Worker Shuttlebus**

- 3.6 It is anticipated the majority of non-local construction workers will stay at local accommodation and be transported to Site by shuttlebus. This can be used by local workforce as well. This aids to further reduce single occupancy vehicle travel to the Site, the appointed contractor and TPC will be responsible for organising a shuttlebus for construction workers.

### **Monitoring**

- 3.7 The uptake of travel plan measures will be continuously monitored by the TPC. Additional measures will be provided as appropriate.

# Document Management

© 2022 Transport Planning Associates Limited. All Rights Reserved.

This document has been prepared by Transport Planning Associates for the sole use of our client in accordance with generally accepted consultancy principles, the budget for fees and the terms of service agreed between Transport Planning Associates and our client. Any information provided by third parties and referred to herein has not been checked or verified by Transport Planning Associates, unless otherwise expressly stated in the document. No third parties may rely upon this document without the prior and express written agreement of Transport Planning Associates.

## Document Review

	Status	Author	Checker	Approver	Date
01	Draft	AC	RR	JD	09   12   20
-	Issue				
A	Revision <sup>a</sup>				
B	Revision <sup>b</sup>				

---

<sup>a</sup>  
<sup>b</sup>